

Sliding Patio Screens..... 14.3
Hinged Patio Screens..... 14.4
Doorlite Parts 14.5
Sill Parts 14.6
Door Bottom & Hinge Parts 14.8
Steel Frame Parts 14.9
End Rails and Raised Panel Tape 14.11
Stainable & Standard Astragal Parts 14.12
Transom Parts & Cove Molding 14.13
Wood Frame Parts..... 14.14

SLIM PROFILE PATIO SCREENS

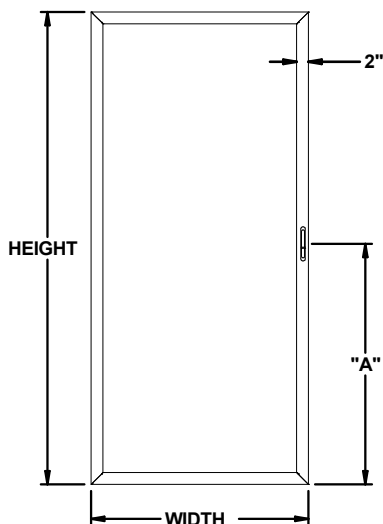

Hand Designations (Viewed from the exterior)	
F	Fixed Panel
L	Left Hand
R	Right Hand

Designation	Screen Hand
LF	Left
RF	Left
FL	Right
FR	Right
RFF	Left
LFF	Left
FRF	Left
FLF	Right
FFR	Right
FFL	Right

SLIM PROFILE SLIDING SCREEN SIZING				
	SCREEN SIZE	WIDTH	HEIGHT	"A"
6/6 HEIGHT	2/4	28.594	77.172	38.586
	2/6	30.594	77.172	38.586
	2/8	32.594	77.172	38.586
	2/10	34.594	77.172	38.586
	3/0	36.594	77.172	38.586
6/8 HEIGHT	2/4	28.594	79.469	39.735
	2/6	30.594	79.469	39.735
	2/8	32.594	79.469	39.735
	2/10	34.594	79.469	39.735
	3/0	36.594	79.469	39.735
7/0 HEIGHT	2/4	28.594	83.469	40.000
	2/6	30.594	83.469	40.000
	2/8	32.594	83.469	40.000
	2/10	34.594	83.469	40.000
	3/0	36.594	83.469	40.000
8/0 HEIGHT	2/4	28.594	95.469	40.000
	2/6	30.594	95.469	40.000
	2/8	32.594	95.469	40.000
	2/10	34.594	95.469	40.000
	3/0	36.594	95.469	40.000

6/6 AND 6/8 SCREENS ARE UNHANDED.
7/0 AND 8/0 SCREENS ARE HANDED
(LEFT OR RIGHT).

TOP-HUNG WIDE PROFILE PATIO SCREENS

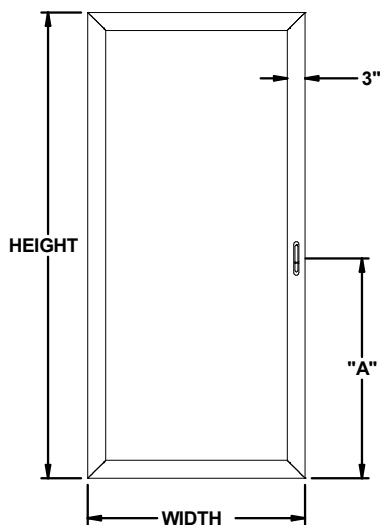

Hand Designations (Viewed from the exterior)	
F	Fixed Panel
L	Left Hand
R	Right Hand

Designation	Screen Hand
LF	Left
RF	Left
FL	Right
FR	Right
RFF	Left
LFF	Left
FRF	Left
FLF	Right
FFR	Right
FFL	Right

TOP-HUNG WIDE PROFILE SLIDING PATIO SCREEN SIZING				
	SCREEN SIZE	WIDTH	HEIGHT	"A"
6/6 HEIGHT	2/4	28.594	76.047	38.024
	2/6	30.594	76.047	38.024
	2/8	32.594	76.047	38.024
	2/10	34.594	76.047	38.024
	3/0	36.594	76.047	38.024
6/8 HEIGHT	2/4	28.594	78.344	39.172
	2/6	30.594	78.344	39.172
	2/8	32.594	78.344	39.172
	2/10	34.594	78.344	39.172
	3/0	36.594	78.344	39.172
7/0 HEIGHT	2/4	28.594	82.344	40.000
	2/6	30.594	82.344	40.000
	2/8	32.594	82.344	40.000
	2/10	34.594	82.344	40.000
	3/0	36.594	82.344	40.000
8/0 HEIGHT	2/4	28.594	94.344	40.000
	2/6	30.594	94.344	40.000
	2/8	32.594	94.344	40.000
	2/10	34.594	94.344	40.000
	3/0	36.594	94.344	40.000

6/6 AND 6/8 SCREENS ARE UNHANDED.
7/0 AND 8/0 SCREENS ARE HANDED
(LEFT OR RIGHT).

Replacement
Parts

DOUBLE DOOR HINGED PATIO SCREENS

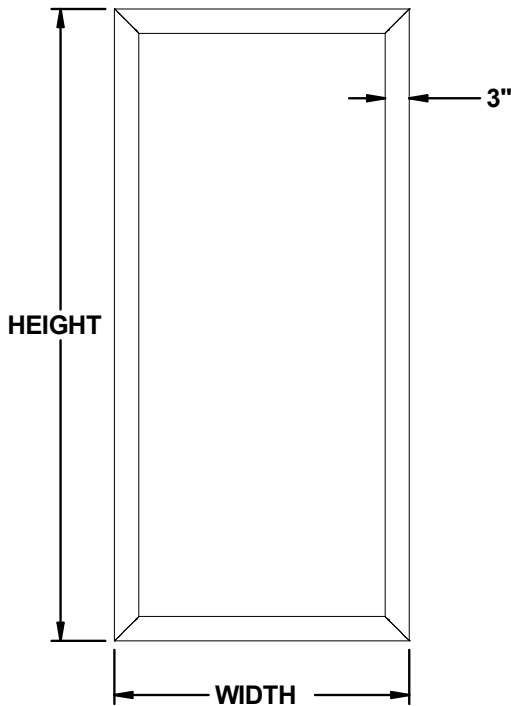

SYSTEM HEIGHT	DOOR WIDTH	SYSTEM WIDTH	SCREEN HEIGHT	SCREEN WIDTH
				7/8" ASTRAGAL
6/6 HEIGHT	2/4	4/8	77.235	27.891
	2/6	5/0		29.891
	2/8	5/4		31.891
	2/10	5/8		33.891
	3/0	6/0		35.891
6/8 HEIGHT	2/4	4/8	79.532	27.891
	2/6	5/0		29.891
	2/8	5/4		31.891
	2/10	5/8		33.891
	3/0	6/0		35.891
7/0 HEIGHT	2/4	4/8	83.532	27.891
	2/6	5/0		29.891
	2/8	5/4		31.891
	2/10	5/8		33.891
	3/0	6/0		35.891
8/0 HEIGHT	2/4	4/8	95.532	27.891
	2/6	5/0		29.891
	2/8	5/4		31.891
	2/10	5/8		33.891
	3/0	6/0		35.891

Replacement
Parts



SMC - Classic-Craft Frames
RP750CAP (Buff)
RPCCMCAP (Mahogany)



TCM - Fiber-Classic Frames &
Flat Frame
RPTCMCAP-B (Buff)



BTS 200 Oval Frames &
Flat Frame
RP200CAP-NT (White)



Pre 2006
270/DL137/Venetian Blind Door Lites
RPVBLCAP (White)



BTS/TCM Frames
RPBTSCAP (White)
RPBTSCAPB (Beige)
RPBTSCAP18 (White)



Dentil Shelf Plugs
CCAPLUG (3 per bag)

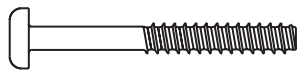

#8 x 1-3/8"
SMC Doorlite Screw
SCSMC750

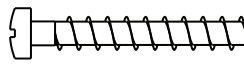

#8 x 1-1/8"
BTS Doorlite Screw
SCDL1125



#10 x 1-1/2"
Impact Lite Frame
& Dentil Shelf Screw
SCCCA150



#8 x 1-3/4"
SMC Doorlite Screw
SCSMCL

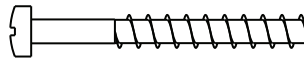

#8 x 1-1/2"
TCM/BTS Doorlite Screw
SCDL000



Venetian Blind Doorlites,
DL137 & 270
RPSCVB (11 per Bag)

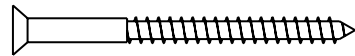

#6 x 1-3/4"
Lineal Lite Frame Screw
RPSCFCLDL (Bronze)
RPSCLDL (White)



#10 x 2"
Wrought Iron Frame Screw
CCRSREW

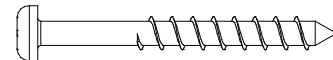

#8 x 1-1/2"
Flat Frame Screw
PVCSCREW15

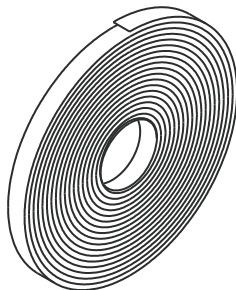

Glazing Tape - Black
(glaze glass to lite frame)
RPGZGS 50ft.

Foam Glazing Tape - White
1/4" x 1/8" thick
(Foam tape used on edge of lite
frame to seal against door)
RPLZTP 50ft. Roll

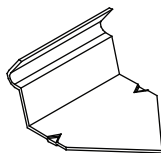

Classic-Craft
Grille Clip
RPCGC

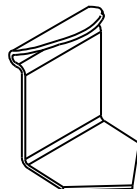

1994 Wood Grille
Metal Clip
RPWGMC2

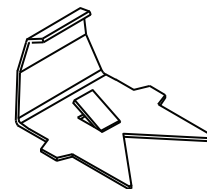

Flush-Glazed Wood
Grille Metal Clip
RPFGGC

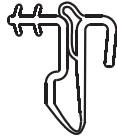

Sill Gasket - Composite/Hardwood
Adjustable Sill
3/0 - RPTDSLGSKT30
6/0 - RPTDSLGSKT60



Basic Composite Adjustable
Inswing Sill Plug
RPISLCOVER-D (Dark Wood)
RPISLCOVER-L (Light Wood)

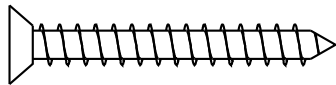

Outswing Bumper Sill
(Anchoring to sub-floor)
#10 x 1-1/2"
RPSCOSS

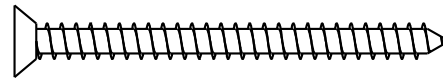

Sill Screw
#8 x 2"
RPSCSBS

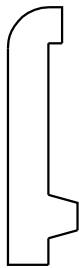

Adjustable Sill Nosing
3/0 - RPOAKBCK30A
6/0 - RPOAKBCK60A



Composite/Hardwood
Sill Nosing
RPTD _____



Basic Composite Adjustable Inswing Sill Nosing
(Dark Wood) RPISL30NOSING-D
(Light Wood) RPISL30NOSING-L

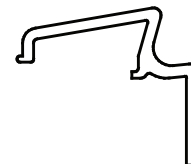

Replacement Vinyl
3/0 - ISL3FCAP330-R
6/0 - ISL3FCAP740-R

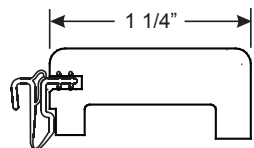
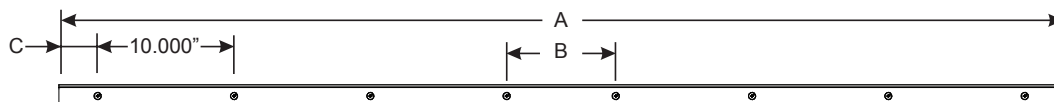

Cap - Composite/Hardwood Adjustable
SCA___

Composite Hardwood Adjustable Sill Cap Screw Locations			
	OVERALL LENGTH "A"	CENTER SCREW "B"	FIRST SCREW LOCATION "C"
2/6 SINGLE	30.781	N/A	5.391
2/8 SINGLE	32.781		1.391
2/10 SINGLE	34.781		2.391
3/0 SINGLE	36.781		3.391
4/8 FRENCH	57.781	10.000	3.890
5/0 FRENCH	61.781	10.000	5.890
5/4 FRENCH	65.781	10.000	7.890
5/8 FRENCH	69.781	7.000	1.390
6/0 FRENCH	73.781	8.000	2.890
LINEAL	112.345	6.500	2.923

Composite Hardwood Adjustable Sill Cap Screw Locations (Before 2013)								
	"A"	"B"	"C"	"D"	"E"	"F"	"G"	"H"
4/8 FRENCH	10.000	10.000	10.000	N/A	2.953	4.734	26.073	57.687
5/0 FRENCH	5.000	5.000	10.000	10.000	2.453	4.234	28.073	61.687
5/4 FRENCH	10.000	10.000	10.000	5.000	2.844	2.844	30.073	65.687
5/8 FRENCH	5.000	5.000	10.000	10.000	1.453	3.234	32.073	69.687
6/0 FRENCH	8.000	8.000	10.000	10.000	2.844	2.844	34.073	73.687

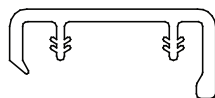

Cap - Basic Composite Adjustable Inswing
(Dark Wood) RPISL30ACAP-D
(Light Wood) RPISL30ACAP-L

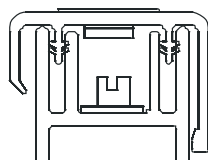
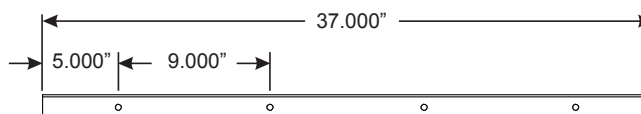

Kit - Basic Composite Adjustable Inswing
(Dark Wood) RPISL30AKIT-D
(Light Wood) RPISL30AKIT-L

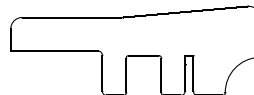

Cap - Composite Outswing
(Dark Wood) - SCO___D
(Light Wood) - SCO___L
(Stone) - SCO___T

DOOR BOTTOM

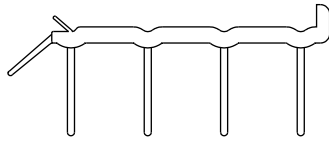

Sweep/Replacement Door Bottom
DB30SWP

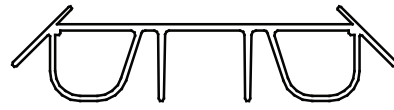

Dual Bulbed Kerfless Door Bottom
RPDBDB300

HINGE PARTS

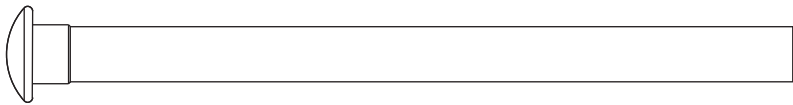

Hinge Pin
MS000HP



Spring Hinge - Cross Pin
MS0SLHP

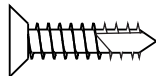

Hinge Screw
#10 x 3/4"

- RPSCJBB-YZ - Yellow Zinc
- RPSCJBB-1C - Brushed Nickel
- RPSCJBB-1D - Black Nickel
- RPSCJBB-SS - Stainless Steel
- RPSCJBB-AN - Nickel
- RPSCJBB-PC - Chrome
- RPSCJBB-AR - Antique Brass

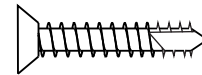

Hinge - Door
#10 x 1"

- RPSCDRB-YZ - Yellow Zinc
- RPSCDRB-1A - Brass
- RPSCDRB-1C - Brushed Nickel
- RPSCDRB-1D - Black Nickel
- RPSCDRB-SS - Stainless Steel
- RPSCDRB-AR - Antique Brass
- RPSCDRB-AN - Antique Nickel
- RPSCDRB-PC - Polished Chrome



Phillips Flat Head
#8 x 3/4"

- SCSS875-AR - Antique Brass
- SCSS875-AN - Antique Nickel
- SCSS875-1D - Black Nickel
- SCSS875-PC - Polished Chrome
- SCSS875SS - Stainless Steel
- SCSS875-1C - Brushed Nickel



Phillips Flat Head
#8 x 1-1/4"

- SCSS8125-AR - Antique Brass
- SCSS8125-AN - Antique Nickel
- SCSS8125-1D - Black Nickel
- SCSS8125-PC - Polished Chrome
- SCSS8125SS - Stainless Steel
- SCSS8125-1C - Brushed Nickel

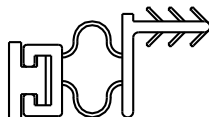

Magnetic Weatherstrip
Head

- WI30B08 - White
- WH30B08 - Bronze
- Lock
- WI00BL8 - White
- WH00BL8 - Bronze

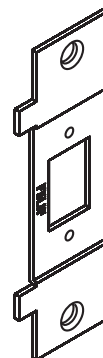

Adjusta-Fit 2
Converter Plate
FSLIP

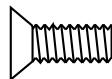

- 10-24 x 1/2" Hinge Machine Screw
- RPSCSF-1H - Oil Rubbed Bronze
- RPSCSF-YZ - Zinc Dichromate
- RPSCSF-1C - Brushed Nickel
- RPSCSF-PC - Polished Chrome

Steel Frame Parts

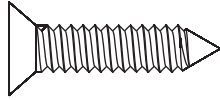

(2) #8 x 3/4" Phillips Flathead Wood Screws

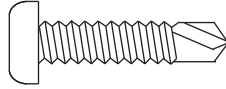

(5) #10 x 3/4" Phillips Panhead TEKS 2 Screws

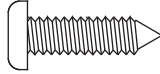

(5) #8 x 1/2" Phillips Panhead Spear tip Screws (white)



(3) 9/16" x 15/16" x 1/8" Spacers

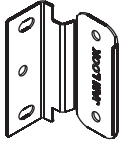

(1) "L" Bracket Transport Clip

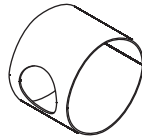

(2) Lock Bore Sleeve



Shop Prehanging Instructions for Adjusta-Fit₂

Read all instructions carefully before pre-hanging your new Thermo-Tru Adjusta-Fit₂ system.

Please note there are separate "Installation Instructions" for your Adjusta-Fit₂ system.

For information on where to purchase Thermo-Tru entry door systems, call 1-800-THERMA-TRU (843-7429) or visit www.thermatru.com

Pre-Hanging Hardware Package TA2HS

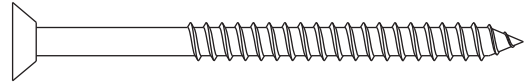

(6) #10 x 2-1/2" Phillips Flathead Screws



(2) #8 x 1-1/4" Phillips Flathead Screws



(2) #8 x 3/4" Phillips Flathead Wood Screws

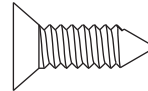

(2) #12-24 x 3/4" Phillips Flathead Type "A" Machine Screw



Deadbolt Cover (Door)
1-1/8" x 2-1/4"

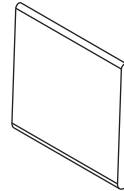

(2) Jamb seal pads



Deadbolt Cover (Frame)
1-1/8" x 2-3/4"



Converter Plate



(2) 1-1/8" x 2-1/4" Deadbolt Filler



(2) #8-32 x 3/8" Self tapping Screw Type "F"



Site Installation Instructions for Adjusta-Fit₂

Read all instructions carefully before installing your new Thermo-Tru Adjusta-Fit₂ system.

Please note there are separate "Prehanging Instructions" to be reviewed and followed prior to completing the installation.

CODES
Building codes may vary from area to area. If a fire rating is required of the door and opening being framed, the installer must use installation materials and methods to satisfy the authority having jurisdiction. Thermo-Tru provides labeled products, but bears no responsibility for installation.

Field Installation Hardware Package TB2HF

REPLACEMENT END RAILS

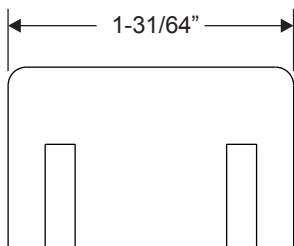

Classic-Craft
RPCCER30C (3/0)
RPCCER36SS (3/6)

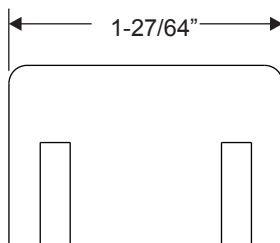

8' Classic-Craft
RPCCER30SS



Steel
RPER30C (3/0)
RPER36C (3/6)

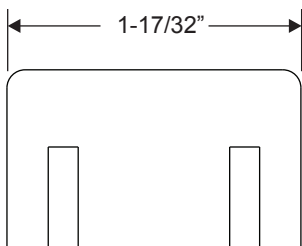

Fiber-Classic/Smooth-Star
RPSSFCER30C

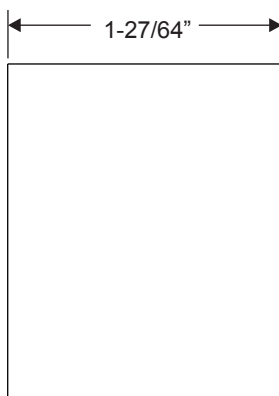

Classic-Craft Full Plank
CCER30SSPLK
CCER36SSPLK

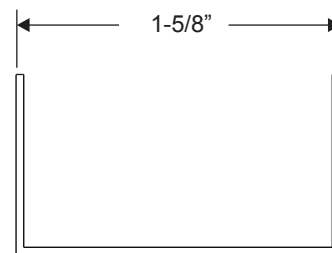

Fire Door
RPSEDR26 (2/6)
RPSEDR28 (2/8)
RPSEDR21 (2/10)
RPSEDR30 (3/0)
RPSEDR36 (2/6)

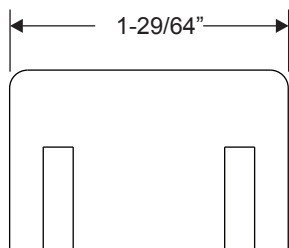

8' Fiber-Classic
RPFCE308C

RAISED PANEL PAD & TAPE

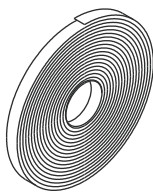

VHB Tape - 36 yds
Classic-Craft
Raised Panel
RPRPTAPECC

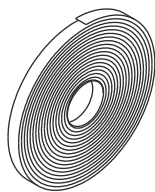

VHB Tape - 36 yds
Smooth-Star
Raised Panel &
Classic-Craft DP300CC
RPRPTAPESS

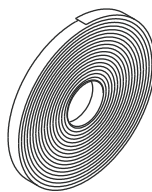

VHB Tape - 216 Ft. Roll
90 Minute Fire Door
Cutdown End Rails
RPSEDRTP216



Neoprene Pad
Classic-Craft Raised Panels
DP1244CC & DP1244STCC
RPRPPAD 14/PKG

Stainable & Standard Astragal Parts

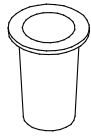

Fill Plug
MEDFILLPLUG

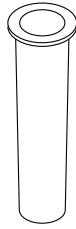

Deep Fill Plug
HASTRSLPG-R



Snap-In Trim Strip
RPATRMW (White)
RPATRMB (Bronze)

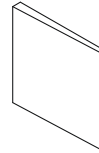

Corner Seal Pad
AS-5134091-R

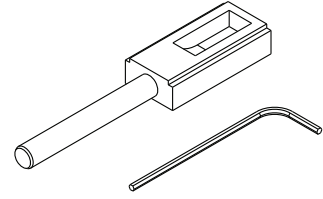

Slide Bolt
2-5/8" Long
White - RRBOLTS
Bronze - RPBOLTSB
Stone - AS-BOLTST-R
17" Long
White - RPBOLTL
Bronze - RPBOLTLB
Stone - AS-BOLTTL-R

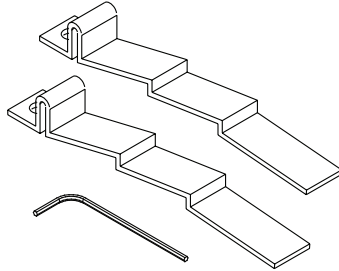

Bolt Spring Kit
RPSPREPKIT

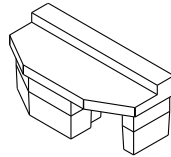

Outswing Boot
(Inswing Top Boot)
RPTOPBT

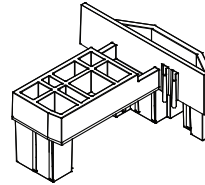

Inswing Bottom Rubber Boot
7ASTBOOTR450 (Right)
7ASTBOOTL450 (Left)



Hex Key
AS-5136015-R

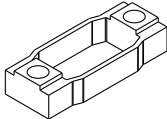

Strike Boss
RPSBOSS

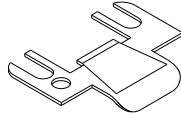

Strike Plate
SP026B02A-XX

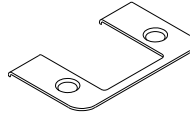

Strike Cover
SP026C03-XX

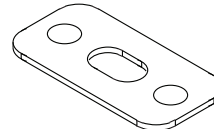

Keeper Plate
AS5136010-R

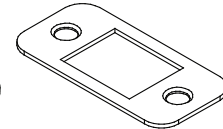

Deadbolt Plate
AS-5136119-R

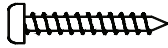

Astragal Mounting Screws
#10 x 1-1/2"
Pan Head Screws
SCCA150



Keeper Plate Screws (Sill)
#8 x 1-1/4"
Flat Head Screws
SCSS8125

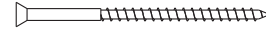

Keeper Plate Screws (Head)
#8 x 2-1/2"
Flat Head Screws
SCSS821

Astragal Hardware Package
RPAHWB

Corner Pad

Fill Plug

Strike Plate

Backing Plate

Deadbolt Plate

Bolt Strike w/ Screws
(2) #6 x 1"
Phillips Flat Head

Astragal Mounting Screws
(9) #10 x 1-1/2"
Pan Head Screws

Astragal Strike Screws
(2) #8 x 1-1/2"
Flat Head Screws

Hinge Screws
(8) #10 x 2-1/2"
Flat Head Screws

Replacement
Parts



Exterior Elliptical Trim

- 3/0 w/2 12" SL Continuous RPTME30D2050
- 3/0 w/2 14" SL Continuous RPTME30D4050

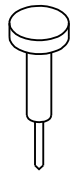

Pre-1987
Grille Pin
RPFGPIN

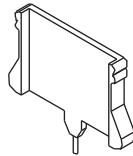

Grille Stick Pin
RPTGNAIL

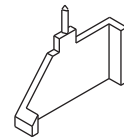

Elliptical
Grille Pin
RPTGNAILEP-R
RPTGNAILEP-L

For Prehung Unit Installation
Screw Package "A"
(Site Applied)
Part # MSSCRPA-XX

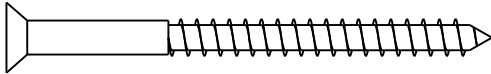

#10 x 2-1/2"
Phillips Flat Head
(2) Hinge - Jamb Leaf
Part # SC21BHS-XX

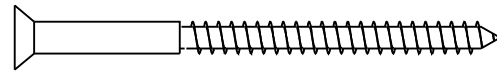

#8 x 2-1/2"
Phillips Flat Head
(2) Security Strike Plate
Part # SCSS821-XX

JAMB-JACK SCREW & CAP

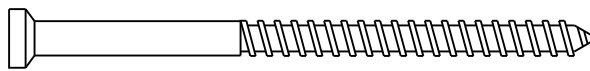

#10 x 3-1/4"

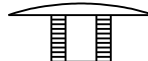

Finish Cap
JJCAP100

Jamb-Jack Screw & Cap
JJJC06

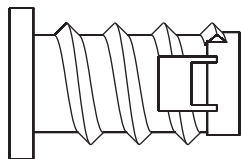

Jamb-Jack Insert
Part # JJINS



Special Bit
Part # JJTDRVR

Transport Clip
Part # SCOOTCS

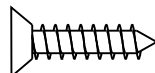

#6 x 3/4"
Phillips Flat Head