

ARCH 1 Dimensional Data

Unit and Rough Opening Sizing.....	1.3
Full Lite Panel Dimensions.....	1.39
6/8 Lip Lite Grille Locations.....	1.45
8/0 Lip Lite Grille Locations.....	1.53
6/8 Flush-Glazed Grille Locations.....	1.62
8/0 Flush-Glazed Grille Locations.....	1.69
Vinyl Sliding Patio Doors.....	1.71

Unit and Rough Opening Sizing

Single or M.E.U. 6/6, 6/8, 7/0, 8/0

Single or M.E.U. - Inswing

Brickmould Dim.	28 1/8"	32 1/8"	34 1/8"	36 1/8"	38 1/8"	40 1/8"	46 1/8"							
Rough Opening	26 3/8"	30 3/8"	32 3/8"	34 3/8"	36 3/8"	38 3/8"	44 3/8"							
Unit Dimension	25 5/8"	29 5/8"	31 5/8"	33 5/8"	35 5/8"	37 5/8"	43 5/8"							
80 3/4"	80"	79 1/2"						78 5/8"	78 1/16"	79 1/8"	78 9/16"	80 1/8"	79 9/16"	
83 1/4"	82 1/2"	82"						81 3/16"	80 5/8"	81 1/16"	81 1/8"	82 1/16"	82 1/8"	
87 1/4"	86 1/2"	86"						85 3/16"	84 5/8"	85 1/16"	85 1/8"	86 1/16"	86 1/8"	
99 1/4"	98 1/2"	98"						97 3/16"	96 5/8"	97 1/16"	97 1/8"	98 1/16"	98 1/8"	
														Unit Dim.
														Rough Opening
														Brickmould Dim.

*For M.E.U., add actual unit dimension to door rough opening width for total rough opening width.

Single or M.E.U. - Outswing

For units with public access sills, subtract 1" from inswing height. Unit widths will be the same as in the table above.

Hand Designations

(Viewed from the exterior)

- F Fixed Panel
- L Left Hand
- R Right Hand

Inswing

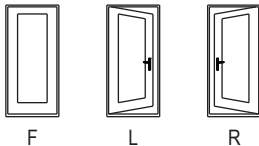

Outswing

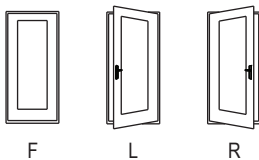

Unit and Rough Opening Sizing

French - 7/8" Astragal, 6/6, 6/8, 7/0, 8/0

French - Inswing - Astragal

Brickmould Dim.	53 1/16"	61 1/16"	65 1/16"	69 1/16"	73 1/16"	77 1/16"	
Rough Opening	51 5/16"	59 5/16"	63 5/16"	67 5/16"	71 5/16"	75 5/16"	
Unit Dimension	50 9/16"	58 9/16"	62 9/16"	66 9/16"	70 9/16"	74 9/16"	
80 3/4" 80" 79 1/2"	6/6						79 9/16" 80 1/8" 78 5/8"
	6/8						81 3/16" 80 5/8" 81 1/8"
	7/0						85 3/16" 84 5/8" 85 1/16"
	8/0						97 3/16" 96 5/8" 97 1/16"
83 1/4" 82 1/2" 82"	4/0	4/8	5/0	5/4	5/8	6/0	82 1/8" 82 1/16" 81 1/8"
87 1/4" 86 1/2" 86"	4/0	4/8	5/0	5/4	5/8	6/0	86 1/8" 86 1/16" 85 1/8"
99 1/4" 98 1/2" 98"	4/0	4/8	5/0	5/4	5/8	6/0	98 1/8" 98 1/16" 97 1/8"
	50 9/16"	58 9/16"	62 9/16"	66 9/16"	70 9/16"	74 9/16"	Unit Dim.
	51 5/16"	59 5/16"	63 5/16"	67 5/16"	71 5/16"	75 5/16"	Rough Opening
	53 9/16"	61 9/16"	65 9/16"	69 9/16"	73 9/16"	77 9/16"	Brickmould Dim.
							Aluminum Composite Aluminum Composite Aluminum Composite Aluminum Composite

French - Outswing - Astragal

For units with public access sills, subtract 1" from inswing height. Unit widths will be the same as in the table above.

Hand Designations	
(Viewed from the exterior)	
A	Astragal (Passive)
L	Left Hand
R	Right Hand

Inswing

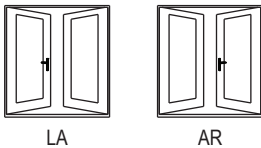

Outswing

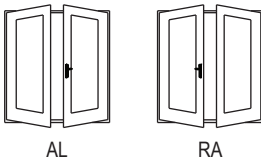

Double - Standard Mullion, 6/6, 6/8, 7/0, 8/0

Double - Inswing - Standard Mullion

Brickmould Dim.	53 5/16"	61 5/16"	65 5/16"	69 5/16"	73 5/16"	77 5/16"			
Rough Opening	51 9/16"	59 9/16"	63 9/16"	67 9/16"	71 9/16"	75 9/16"			
Unit Dimension	50 13/16"	58 13/16"	62 13/16"	66 13/16"	70 13/16"	74 13/16"	Unit Dim.		
80 3/4"							80 1/8"		
80"							79 1/2"	82 1/16"	
83 1/4"							82 1/2"	82"	82 1/16"
86 1/2"							86"	85 11/16"	86 11/16"
87 1/4"	86 1/2"	86"	85 3/16"	85 11/16"	86 11/16"	86 11/16"	Composite		
98 1/2"	98"	97 3/16"	97 11/16"	98 11/16"	98 11/16"	98 11/16"	Composite		
	50 13/16"	58 13/16"	62 13/16"	66 13/16"	70 13/16"	74 13/16"	Unit Dim.		
	51 9/16"	59 9/16"	63 9/16"	67 9/16"	71 9/16"	75 9/16"	Rough Opening		
	53 13/16"	61 13/16"	65 13/16"	69 13/16"	73 13/16"	77 13/16"	Brickmould Dim.		

Double - Outswing - Standard Mullion

Hand Designations	
(Viewed from the exterior)	
F	Fixed Panel
L	Left Hand
R	Right Hand

Inswing

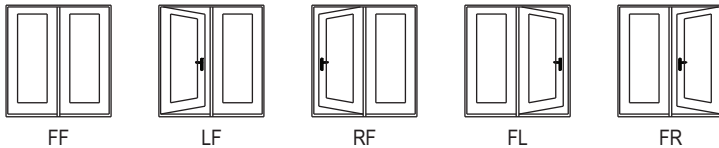

Outswing

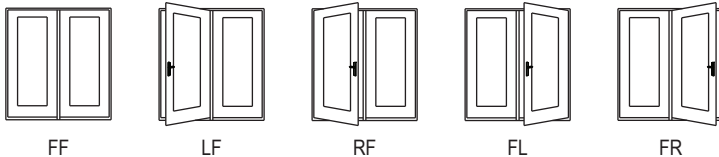

Unit and Rough Opening Sizing

Double - Wide Mullion, 6/6, 6/8, 7/0, 8/0

Double - Inswing - Wide Mullion

Brickmould Dim.	53 13/16"	61 13/16"	65 13/16"	69 13/16"	73 13/16"	77 13/16"		
Rough Opening	52 1/16"	60 1/16"	64 1/16"	68 1/16"	72 1/16"	76 1/16"		
Unit Dimension	51 5/16"	59 5/16"	63 5/16"	67 5/16"	71 5/16"	75 5/16"		
80 3/4" 80" 79 1/2"	6/6							80 1/8" 79 1/8" 78 5/8"
	6/8							82 1/4" 82 1/2" 81 3/16"
	7/0							86 1/4" 86 1/2" 85 3/16"
	8/0							98 1/4" 98 1/2" 97 3/16"
		4/0	4/8	5/0	5/4	5/8	6/0	
		51 5/16"	59 5/16"	63 5/16"	67 5/16"	71 5/16"	75 5/16"	Unit Dim.
		52 1/16"	60 1/16"	64 1/16"	68 1/16"	72 1/16"	76 1/16"	Rough Opening
		54 5/16"	62 5/16"	66 5/16"	70 5/16"	74 5/16"	78 5/16"	Brickmould Dim.

Double - Outswing - Wide Mullion

Hand Designations	
(Viewed from the exterior)	
F	Fixed Panel
L	Left Hand
R	Right Hand

Inswing

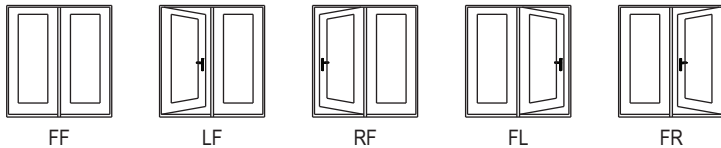

Outswing

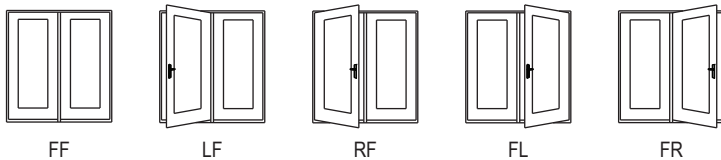

Triple - Standard Mullion - 6/6, 6/8, 7/0, 8/0
Triple - Inswing - Standard Mullion

		78 1/2"	90 1/2"	96 1/2"	102 1/2"	108 1/2"	114 1/2"			
Brickmould Dim.		78 1/2"	90 1/2"	96 1/2"	102 1/2"	108 1/2"	114 1/2"			
Rough Opening		76 3/4"	88 3/4"	94 3/4"	100 3/4"	106 3/4"	112 3/4"			
Unit Dimension		76"	88"	94"	100"	106"	112"			
80 3/4" 80" 79 1/2"	6/6							78 5/8"	80 1/8"	Composite
	6/8							81 1/16"	82 1/16"	Composite
	7/0							85 3/16"	86 1/16"	Composite
	8/0							97 3/16"	98 1/16"	Composite
		76"	88"	94"	100"	106"	112"	Unit Dim.		
		76 3/4"	88 3/4"	94 3/4"	100 3/4"	106 3/4"	112 3/4"	Rough Opening		
		79"	91"	97"	103"	109"	115"	Brickmould Dim.		

Triple - Outswing - Standard Mullion

Hand Designations

(Viewed from the exterior)

- F Fixed Panel
- L Left Hand
- R Right Hand

Inswing

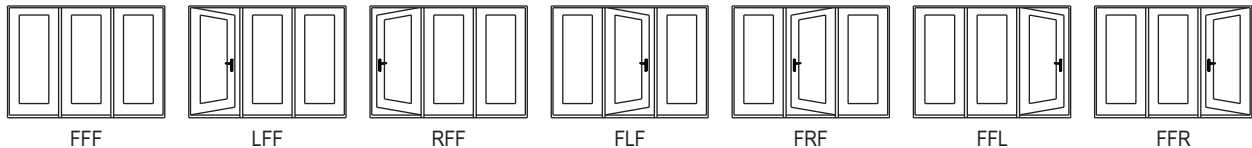

Outswing

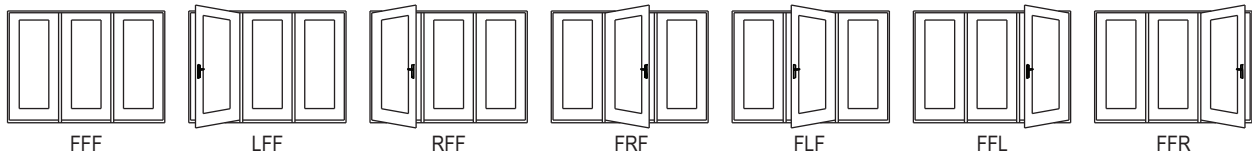

Unit and Rough Opening Sizing

Single - Continuous with 10" Sidelite - Standard Mullion - 6/6, 6/8, 7/0, 8/0 Single with Continuous Sidelite - Inswing - Standard Mullion

Brickmould Dim.	43 1/8"	45 1/8"	47 1/8"	49 1/8"	51 1/8"	57 1/8"									
Rough Opening	41 3/8"	43 3/8"	45 3/8"	47 3/8"	49 3/8"	55 3/8"									
Unit Dimension	40 5/8"	42 5/8"	44 5/8"	46 5/8"	48 5/8"	54 5/8"									
80 3/4" 80" 79 1/2"	6/6							78 5/8"	78 1/16"	79 9/16"	80 1/8"	82 1/16"	82 1/8"	82 1/8"	Aluminum Composite
	6/8							81 3/16"	80 5/8"	81 1/16"	81 1/8"	82 1/16"	85 1/8"	85 1/8"	Aluminum Composite
	7/0							85 3/16"	84 5/8"	85 1/16"	85 1/8"	86 1/16"	86 1/8"	86 1/8"	Aluminum Composite
	8/0							97 3/16"	96 5/8"	97 1/16"	97 1/8"	98 1/16"	98 1/8"	98 1/8"	Aluminum Composite
		40 5/8"	42 5/8"	44 5/8"	46 5/8"	48 5/8"	54 5/8"	Unit Dim.							
		41 3/8"	43 3/8"	45 3/8"	47 3/8"	49 3/8"	55 3/8"	Rough Opening							
		43 5/8"	45 5/8"	47 5/8"	49 5/8"	51 5/8"	57 5/8"	Brickmould Dim.							

Single with Continuous Sidelite - Outswing - Standard Mullion





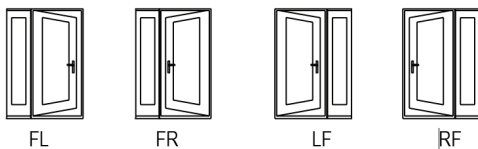

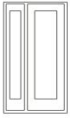
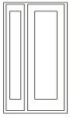

Hand Designations (Viewed from the exterior)	
L	Left Hand
R	Right Hand
F	Fixed Sidelite

Inswing

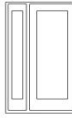
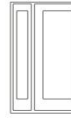
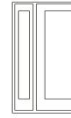
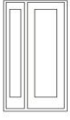
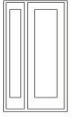

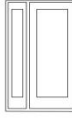
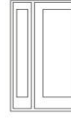
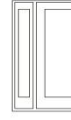
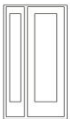
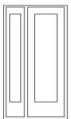
Unit and Rough Opening Sizing

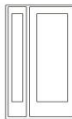
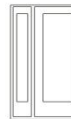
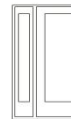
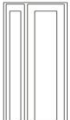
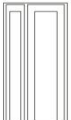
Single - Continuous with 12" Sidelite - Standard Mullion - 6/6, 6/8, 7/0, 8/0 Single with Continuous Sidelite - Inswing - Standard Mullion

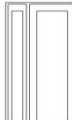
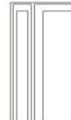
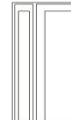
Brickmould Dim.		45 1/8"	47 1/8"	49 1/8"	51 1/8"	53 1/8"	59 1/8"		
Rough Opening		43 3/8"	45 3/8"	47 3/8"	49 3/8"	51 3/8"	57 3/8"		
Unit Dimension		42 5/8"	44 5/8"	46 5/8"	48 5/8"	50 5/8"	56 5/8"		
80 3/4" 80" 79 1/2"	6/6							78 5/8"	79 1/16"
	6/8							81 3/16"	82 1/8"
	7/0							85 3/16"	86 1/8"
	8/0							97 3/16"	98 1/8"
		42 5/8"	44 5/8"	46 5/8"	48 5/8"	50 5/8"	56 5/8"	Unit Dim.	
		43 3/8"	45 3/8"	47 3/8"	49 3/8"	51 3/8"	57 3/8"	Rough Opening	
		45 5/8"	47 5/8"	49 5/8"	51 5/8"	53 5/8"	59 5/8"	Brickmould Dim.	

Single with Continuous Sidelite - Outswing - Standard Mullion

Hand Designations (Viewed from the exterior)

L	Left Hand
R	Right Hand
F	Fixed Sidelite

Inswing

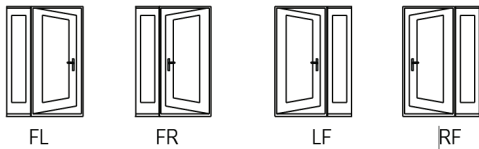

Unit and Rough Opening Sizing

Single - Continuous with 14" Sidelite - Standard Mullion - 6/6, 6/8, 7/0, 8/0 Single with Continuous Sidelite - Inswing - Standard Mullion

Brickmould Dim.	47 1/8"	49 1/8"	51 1/8"	53 1/8"	55 1/8"	61 1/8"							
Rough Opening	45 3/8"	47 3/8"	49 3/8"	51 3/8"	53 3/8"	59 3/8"							
Unit Dimension	44 5/8"	46 5/8"	48 5/8"	50 5/8"	52 5/8"	58 5/8"							
80 3/4" 80" 79 1/2"	6/6							78 5/8"	79 9/16"	80 1/8"	82 1/8"	82 1/8"	Aluminum Composite
		2/4	2/6	2/8	2/10	3/0	3/6						
	6/8							81 3/16"	80 5/8"	81 1/16"	81 1/8"	82 1/16"	Aluminum Composite
		2/4	2/6	2/8	2/10	3/0	3/6						
87 1/4" 86 1/2" 86"	7/0							85 3/16"	84 5/8"	85 1/16"	85 1/8"	86 1/16"	Aluminum Composite
	2/4	2/6	2/8	2/10	3/0	3/6							
99 1/4" 98 1/2" 98"	8/0							97 3/16"	96 5/8"	97 1/16"	97 1/8"	98 1/16"	Aluminum Composite
	2/4	2/6	2/8	2/10	3/0	3/6							
		44 5/8"	46 5/8"	48 5/8"	50 5/8"	52 5/8"	58 5/8"	Unit Dim.					
		45 3/8"	47 3/8"	49 3/8"	51 3/8"	53 3/8"	59 3/8"	Rough Opening					
		47 5/8"	49 5/8"	51 5/8"	53 5/8"	55 5/8"	61 5/8"	Brickmould Dim.					

Single with Continuous Sidelite - Outswing - Standard Mullion





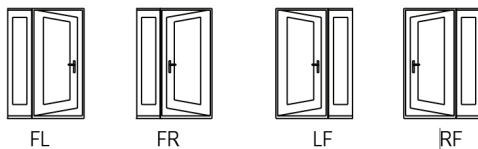





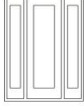

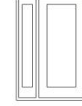
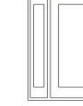
Hand Designations	
(Viewed from the exterior)	
L	Left Hand
R	Right Hand
F	Fixed Sidelite

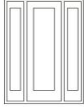
Inswing

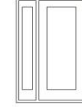

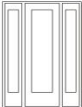
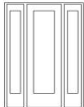
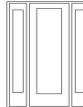
Unit and Rough Opening Sizing

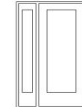
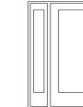
Single - Continuous with 2-10" Sidelites - Standard Mullion - 6/6, 6/8, 7/0, 8/0 Single with Continuous Sidelites - Inswing - Standard Mullion

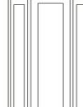
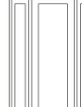
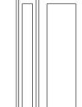
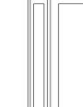
Brickmould Dim.	54 1/8"	56 1/8"	58 1/8"	60 1/8"	62 1/8"	68 1/8"										
Rough Opening	52 3/8"	54 3/8"	56 3/8"	58 3/8"	60 3/8"	66 3/8"										
Unit Dimension	51 5/8"	53 5/8"	55 5/8"	57 5/8"	59 5/8"	65 5/8"										
80 3/4" 80" 79 1/2" 83 1/4" 82 1/2" 82" 87 1/4" 86 1/2" 86" 99 1/4" 98 1/2" 98"	6/6							78 5/8"	79 9/16"	80 1/8"	82 1/8"	82 1/8"	86 1/8"	88 1/8"	98 1/8"	Aluminum Composite
	6/8							81 3/16"	81 9/16"	81 1/8"	82 11/16"	81 1/8"	85 1/8"	86 11/16"	98 11/16"	Aluminum Composite
	7/0							85 3/16"	85 9/16"	84 5/8"	85 11/16"	85 1/8"	89 1/8"	90 1/8"	99 1/8"	Aluminum Composite
	8/0							97 3/16"	97 9/16"	96 5/8"	97 11/16"	97 1/8"	101 1/8"	102 1/8"	101 1/8"	Aluminum Composite
		51 5/8"	53 5/8"	55 5/8"	57 5/8"	59 5/8"	65 5/8"	Unit Dim.								
		52 3/8"	54 3/8"	56 3/8"	58 3/8"	60 3/8"	66 3/8"	Rough Opening								
		54 5/8"	56 5/8"	58 5/8"	60 5/8"	62 5/8"	68 5/8"	Brickmould Dim.								

Single with Continuous Sidelites - Outswing - Standard Mullion





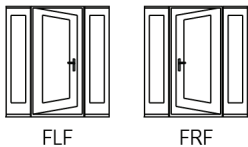





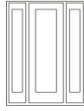





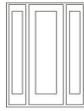

Hand Designations	
(Viewed from the exterior)	
L	Left Hand
R	Right Hand
F	Fixed Sidelite

Inswing

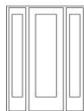

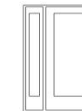
Unit and Rough Opening Sizing

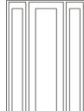
Single - Continuous with 2-12" Sidelites - Standard Mullion - 6/6, 6/8, 7/0, 8/0 Single with Continuous Sidelites - Inswing - Standard Mullion

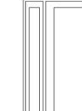
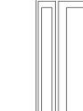
Brickmould Dim.	58 1/8"	60 1/8"	62 1/8"	64 1/8"	66 1/8"	72 1/8"										
Rough Opening	56 3/8"	58 3/8"	60 3/8"	62 3/8"	64 3/8"	70 3/8"										
Unit Dimension	55 5/8"	57 5/8"	59 5/8"	61 5/8"	63 5/8"	69 5/8"										
80 3/4" 80" 79 1/2"	6/6							78 5/8"	78 1/16"	79 9/16"	80 1/8"	82 1/8"	79 9/16"	80 1/8"	82 1/8"	Aluminum Composite
	6/8							81 3/16"	80 5/8"	81 1/16"	81 1/8"	82 1/16"	81 1/16"	81 1/8"	85 1/16"	Aluminum Composite
	7/0							85 3/16"	84 5/8"	85 1/16"	85 1/8"	86 1/16"	85 1/16"	85 1/8"	88 1/8"	Aluminum Composite
	8/0							97 3/16"	96 5/8"	97 1/16"	97 1/8"	98 1/16"	97 1/16"	97 1/8"	98 1/8"	Aluminum Composite
83 1/4" 82 1/2" 82"																
87 1/4" 86 1/2" 86"																
89 1/4" 88 1/2" 88"																
		55 5/8"	57 5/8"	59 5/8"	61 5/8"	63 5/8"	69 5/8"	Unit Dim.								
		56 3/8"	58 3/8"	60 3/8"	62 3/8"	64 3/8"	70 3/8"	Rough Opening								
		58 5/8"	60 5/8"	62 5/8"	64 5/8"	66 5/8"	72 5/8"	Brickmould Dim.								

Single with Continuous Sidelites - Outswing - Standard Mullion

Hand Designations	
(Viewed from the exterior)	
L	Left Hand
R	Right Hand
F	Fixed Sidelite

Inswing

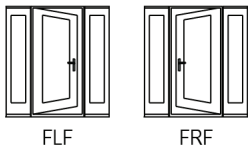

Unit and Rough Opening Sizing

Single - Continuous with 2-14" Sidelites - Standard Mullion - 6/6, 6/8, 7/0, 8/0

Single with Continuous Sidelites - Inswing - Standard Mullion

Brickmould Dim.	62 1/8"	64 1/8"	66 1/8"	68 1/8"	70 1/8"	76 1/8"	
Rough Opening	60 3/8"	62 3/8"	64 3/8"	66 3/8"	68 3/8"	74 3/8"	
Unit Dimension	59 5/8"	61 5/8"	63 5/8"	65 5/8"	67 5/8"	73 5/8"	
80 3/4"	80"	79 1/2"					78 5/8"
83 1/4"	82 1/2"	82"					81 3/16"
87 1/4"	86 1/2"	86"					85 3/16"
99 1/4"	98 1/2"	98"					97 3/16"
	59 5/8"	61 5/8"	63 5/8"	65 5/8"	67 5/8"	73 5/8"	Unit Dim.
	60 3/8"	62 3/8"	64 3/8"	66 3/8"	68 3/8"	74 3/8"	Rough Opening
	62 5/8"	64 5/8"	66 5/8"	68 5/8"	70 5/8"	76 5/8"	Brickmould Dim.
							79 9/16"
							80 1/8"
							82 1/16"
							82 1/8"
							86 1/16"
							86 1/8"
							98 1/16"
							98 1/8"
							Aluminum Composite
							Aluminum Composite
							Aluminum Composite
							Aluminum Composite

Single with Continuous Sidelites - Outswing - Standard Mullion





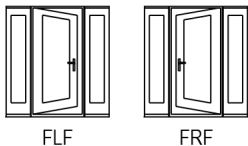





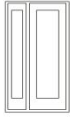



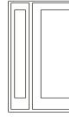

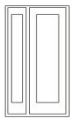

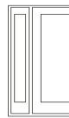

Hand Designations	
(Viewed from the exterior)	
L	Left Hand
R	Right Hand
F	Fixed Sidelite

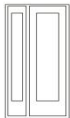
Inswing

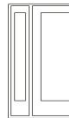

Unit and Rough Opening Sizing

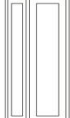
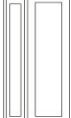
Single with 10" Sidelite - Continuous Wide Mullion or Boxed - 6/6, 6/8, 7/0, 8/0 Single with Boxed Sidelite - Inswing - Continuous Wide Mullion or Boxed

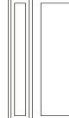
Brickmould Dim.	43 5/8"	45 5/8"	47 5/8"	49 5/8"	51 5/8"	57 5/8"											
Rough Opening	41 7/8"	43 7/8"	45 7/8"	47 7/8"	49 7/8"	55 7/8"											
Unit Dimension	41 1/8"	43 1/8"	45 1/8"	47 1/8"	49 1/8"	55 1/8"											
80 3/4"	80"	79 1/2"	6/6							78 5/8"	78 1/16"	79 9/16"	80 1/8"	82 1/8"	82 1/16"	82 1/8"	Aluminum Composite
				2/4	2/6	2/8	2/10	3/0	3/6	81 3/16"	80 5/8"	81 1/16"	81 1/8"	82 1/16"	82 1/8"	Aluminum Composite	
83 1/4"	82 1/2"	82"	6/8							85 3/16"	84 5/8"	85 1/16"	85 1/8"	86 1/16"	86 1/8"	86 1/8"	Aluminum Composite
				2/4	2/6	2/8	2/10	3/0	3/6	85 3/16"	84 5/8"	85 1/16"	85 1/8"	86 1/16"	86 1/8"	Aluminum Composite	
87 1/4"	86 1/2"	86"	7/0							97 3/16"	96 5/8"	97 1/16"	97 1/8"	98 1/16"	98 1/8"	98 1/8"	Aluminum Composite
				2/4	2/6	2/8	2/10	3/0	3/6	97 3/16"	96 5/8"	97 1/16"	97 1/8"	98 1/16"	98 1/8"	Aluminum Composite	
99 1/4"	98 1/2"	98"	8/0							Unit Dim.							
				2/4	2/6	2/8	2/10	3/0	3/6	Unit Dim.							
				41 1/8"	43 1/8"	45 1/8"	47 1/8"	49 1/8"	55 1/8"	Unit Dim.							
				41 7/8"	43 7/8"	45 7/8"	47 7/8"	49 7/8"	55 7/8"	Rough Opening							
				44 1/8"	46 1/8"	48 1/8"	50 1/8"	52 1/8"	58 1/8"	Brickmould Dim.							

Single with Boxed Sidelite - Outswing - Continuous Wide Mullion or Boxed

Hand Designations (Viewed from the exterior)	
L	Left Hand
R	Right Hand
F	Fixed Sidelite

Inswing

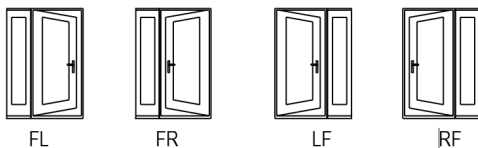

Unit and Rough Opening Sizing

Single with 12" Sidelite - Continuous Wide Mullion or Boxed - 6/6, 6/8, 7/0, 8/0

Single with Boxed Sidelite - Inswing - Continuous Wide Mullion or Boxed

Brickmould Dim.	45 5/8"	47 5/8"	49 5/8"	51 5/8"	53 5/8"	59 5/8"						
Rough Opening	43 7/8"	45 7/8"	47 7/8"	49 7/8"	51 7/8"	57 7/8"						
Unit Dimension	43 1/8"	45 1/8"	47 1/8"	49 1/8"	51 1/8"	57 1/8"						
80 3/4" 80" 79 1/2"	6/6							79 9/16"	80 1/8"	82 1/16"	82 1/8"	Aluminum Composite
		2/4	2/6	2/8	2/10	3/0	3/6					
	6/8							81 1/16"	80 5/8"	81 1/16"	81 1/8"	Aluminum Composite
		2/4	2/6	2/8	2/10	3/0	3/6					
87 1/4" 86 1/2" 86"	7/0							85 3/16"	84 5/8"	85 1/16"	85 1/8"	Aluminum Composite
		2/4	2/6	2/8	2/10	3/0	3/6					
99 1/4" 98 1/2" 98"	8/0							97 3/16"	96 5/8"	97 1/16"	97 1/8"	Aluminum Composite
		2/4	2/6	2/8	2/10	3/0	3/6					
		43 1/8"	45 1/8"	47 1/8"	49 1/8"	51 1/8"	57 1/8"	Unit Dim.				
		43 7/8"	45 7/8"	47 7/8"	49 7/8"	51 7/8"	57 7/8"	Rough Opening				
		46 1/8"	48 1/8"	50 1/8"	52 1/8"	54 1/8"	60 1/8"	Brickmould Dim.				

Single with Boxed Sidelite - Outswing - Continuous Wide Mullion or Boxed

Hand Designations	
(Viewed from the exterior)	
L	Left Hand
R	Right Hand
F	Fixed Sidelite

Inswing

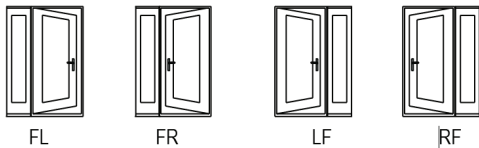

Unit and Rough Opening Sizing

Single with 14" Sidelite - Continuous Wide Mullion or Boxed - 6/6, 6/8, 7/0, 8/0

Single with Boxed Sidelite - Inswing - Continuous Wide Mullion or Boxed

Brickmould Dim.	47 5/8"	49 5/8"	51 5/8"	53 5/8"	55 5/8"	61 5/8"					
Rough Opening	45 7/8"	47 7/8"	49 7/8"	51 7/8"	53 7/8"	59 7/8"					
Unit Dimension	45 1/8"	47 1/8"	49 1/8"	51 1/8"	53 1/8"	59 1/8"					
80 3/4" 80" 79 1/2"	6/6							79 9/16"	80 1/8"	82 1/8"	Aluminum
	6/8							81 3/16"	80 5/8"	81 1/8"	Aluminum
	7/0							85 3/16"	84 5/8"	85 1/8"	Aluminum
	8/0							97 3/16"	96 5/8"	97 1/8"	Aluminum
83 1/4" 82 1/2" 82"	6/6							82 1/16"	82 1/8"	82 1/16"	Composite
87 1/4" 86 1/2" 86"	6/8							85 3/16"	84 5/8"	85 1/16"	Composite
87 1/4" 86 1/2" 86"	7/0							85 3/16"	84 5/8"	85 1/16"	Composite
99 1/4" 98 1/2" 98"	8/0							97 3/16"	96 5/8"	97 1/16"	Composite
	2/4	2/6	2/8	2/10	3/0	3/6					
	45 1/8"	47 1/8"	49 1/8"	51 1/8"	53 1/8"	59 1/8"	Unit Dim.				
	45 7/8"	47 7/8"	49 7/8"	51 7/8"	53 7/8"	59 7/8"	Rough Opening				
	48 1/8"	50 1/8"	52 1/8"	54 1/8"	56 1/8"	62 1/8"	Brickmould Dim.				

Single with Boxed Sidelite - Outswing - Continuous Wide Mullion or Boxed

Hand Designations	
(Viewed from the exterior)	
L	Left Hand
R	Right Hand
F	Fixed Sidelite

Inswing

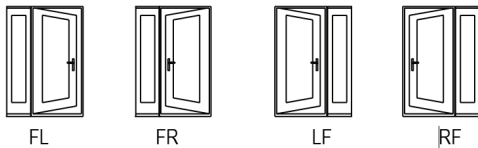

Unit and Rough Opening Sizing

Single with 2-10" Sidelites - Continuous Wide Mullion or Boxed - 6/6, 6/8, 7/0, 8/0

Single with Boxed Sidelites - Inswing - Continuous Wide Mullion or Boxed

Brickmould Dim.	55 1/8"	57 1/8"	59 1/8"	61 1/8"	63 1/8"	69 1/8"		
Rough Opening	53 3/8"	55 3/8"	57 3/8"	59 3/8"	61 3/8"	67 3/8"		
Unit Dimension	52 5/8"	54 5/8"	56 5/8"	58 5/8"	60 5/8"	66 5/8"		

80 3/4" 80" 79 1/2"	6/6							78 5/8"	78 1/16"	79 9/16"	80 1/8"	82 1/8"	82 1/16"	86 1/8"	86 1/16"	98 1/8"	98 1/16"	Aluminum
	6/8							81 3/16"	80 5/8"	81 1/16"	81 1/8"	82 1/16"	85 1/8"	86 1/16"	97 1/8"	98 1/16"	Composite	
	7/0							85 3/16"	84 5/8"	85 1/16"	85 1/8"	86 1/16"	88 1/8"	88 1/16"	97 1/8"	98 1/16"	Aluminum	
	8/0							97 3/16"	96 5/8"	97 1/16"	97 1/8"	98 1/16"	98 1/8"	98 1/16"	97 1/8"	98 1/16"	Composite	
87 1/4" 86 1/2" 86"																		
83 1/4" 82 1/2" 82"																		
99 1/4" 98 1/2" 98"																		

52 5/8"	54 5/8"	56 5/8"	58 5/8"	60 5/8"	66 5/8"	Unit Dim.	
53 3/8"	55 3/8"	57 3/8"	59 3/8"	61 3/8"	67 3/8"	Rough Opening	
55 5/8"	57 5/8"	59 5/8"	61 5/8"	63 5/8"	69 5/8"	Brickmould Dim.	

Single with Boxed Sidelites - Outswing - Continuous Wide Mullion or Boxed

Hand Designations	
(Viewed from the exterior)	
L	Left Hand
R	Right Hand
F	Fixed Sidelite

Inswing

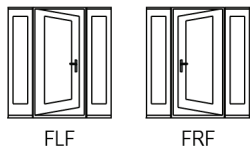

Unit and Rough Opening Sizing

Single with 2-12" Sidelites - Continuous Wide Mullion or Boxed - 6/6, 6/8, 7/0, 8/0

Single with Boxed Sidelites - Inswing - Continuous Wide Mullion or Boxed

Brickmould Dim.	59 1/8"	61 1/8"	63 1/8"	65 1/8"	67 1/8"	73 1/8"							
Rough Opening	57 3/8"	59 3/8"	61 3/8"	63 3/8"	65 3/8"	71 3/8"							
Unit Dimension	56 5/8"	58 5/8"	60 5/8"	62 5/8"	64 5/8"	70 5/8"							
	80 3/4"	80"	79 1/2"										
	83 1/4"	82 1/2"	82"										
	87 1/4"	86 1/2"	86"										
	99 1/4"	98 1/2"	98"										
	2/4	2/6	2/8	2/10	3/0	3/6							
	2/4	2/6	2/8	2/10	3/0	3/6							
	2/4	2/6	2/8	2/10	3/0	3/6							
	2/4	2/6	2/8	2/10	3/0	3/6							
	78 5/8"	78 1/16"	80 1/8"	81 1/8"	82 1/8"	86 1/8"	88 1/8"	98 1/8"	Aluminum				
	81 3/16"	80 5/8"	81 1/16"	81 1/8"	82 1/16"	86 1/16"	86 1/8"	98 1/16"	Composite				
	85 3/16"	84 5/8"	85 1/16"	85 1/8"	86 1/16"	90 1/16"	90 1/8"	102 1/16"	Aluminum				
	97 3/16"	96 5/8"	97 1/16"	97 1/8"	98 1/16"	102 1/16"	102 1/8"	114 1/16"	Composite				
									Aluminum				
									Composite				
	56 5/8"	58 5/8"	60 5/8"	62 5/8"	64 5/8"	70 5/8"	Unit Dim.						
	57 3/8"	59 3/8"	61 3/8"	63 3/8"	65 3/8"	71 3/8"	Rough Opening						
	59 5/8"	61 5/8"	63 5/8"	65 5/8"	67 5/8"	73 5/8"	Brickmould Dim.						

Single with Boxed Sidelites - Outswing - Continuous Wide Mullion or Boxed

Hand Designations (Viewed from the exterior)	
L	Left Hand
R	Right Hand
F	Fixed Sidelite

Inswing

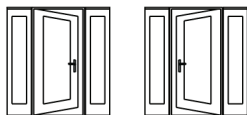

FLF

FRF

Unit and Rough Opening Sizing

Single with 2-14" Sidelites - Continuous Wide Mullion or Boxed - 6/6, 6/8, 7/0, 8/0

Single with Boxed Sidelites - Inswing - Continuous Wide Mullion or Boxed

Brickmould Dim.	63 1/8"	65 1/8"	67 1/8"	69 1/8"	71 1/8"	77 1/8"			
Rough Opening	61 3/8"	63 3/8"	65 3/8"	67 3/8"	69 3/8"	75 3/8"			
Unit Dimension	60 5/8"	62 5/8"	64 5/8"	66 5/8"	68 5/8"	74 5/8"			
80 3/4" 80" 79 1/2"							78 5/8"	78 1/16"	79 9/16"
									80 1/8"
									80 1/8"
									80 1/8"
83 1/4" 82 1/2" 82"							81 3/16"	80 5/8"	81 1/8"
									82 1/16"
87 1/4" 86 1/2" 86"							85 3/16"	84 5/8"	85 1/8"
									86 1/16"
99 1/4" 98 1/2" 98"							97 3/16"	96 5/8"	97 1/8"
									98 1/16"
							Unit Dim.	Aluminum	Aluminum
							Rough Opening	Composite	Composite
							Brickmould Dim.	Aluminum	Aluminum
	60 5/8"	62 5/8"	64 5/8"	66 5/8"	68 5/8"	74 5/8"		Composite	Composite
	61 3/8"	63 3/8"	65 3/8"	67 3/8"	69 3/8"	75 3/8"		Aluminum	Aluminum
	63 5/8"	65 5/8"	67 5/8"	69 5/8"	71 5/8"	77 5/8"		Composite	Composite

Single with Boxed Sidelites - Outswing - Continuous Wide Mullion or Boxed

Hand Designations	
(Viewed from the exterior)	
L	Left Hand
R	Right Hand
F	Fixed Sidelite

Inswing

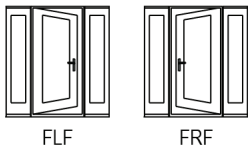

Unit and Rough Opening Sizing

Sidelite 6/6, 6/8, 7/0, 8/0 Sidelite - Inswing

Rough Opening		*	*	*		
Unit Dimension		11 1/2"	13 1/2"	15 1/2"		
80"	79 1/2"	6/6			78 5/8"	78 9/16"
	82 1/2"	6/8			81 3/16"	81 1/8"
	86 1/2"	7/0			85 3/16"	85 1/8"
	98 1/2"	8/0			97 3/16"	97 1/8"
		10"	12"	14"	78 5/8"	78 9/16"
		10"	12"	14"	81 3/16"	81 1/8"
		10"	12"	14"	85 3/16"	85 1/8"
		10"	12"	14"	97 3/16"	97 1/8"
		11 1/2"	13 1/2"	15 1/2"	Unit Dim.	Aluminum Composite
		*	*	*	Rough Opening	Aluminum Composite

Sidelite - Outswing

*Add actual unit dimension to door rough opening width for total rough opening width.

Hand Designations (Viewed from the exterior)	
F	Fixed Panel

Inswing



F

Outswing







F

Unit and Rough Opening Sizing

Single with 12" Venting Sidelite - Wide Mullion 6/6, 6/8, 8/0

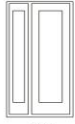
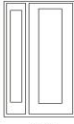
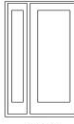
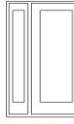
Single with Venting Sidelite - Wide Mullion

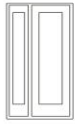
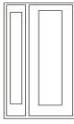
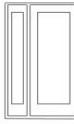
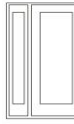
Brickmould Dim.	45 7/8"	47 7/8"	49 7/8"	51 7/8"	53 7/8"
Rough Opening	44 1/8"	46 1/8"	48 1/8"	50 1/8"	52 1/8"
Unit Dimension	43 3/8"	45 3/8"	47 3/8"	49 3/8"	51 3/8"

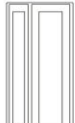
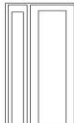
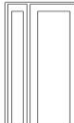
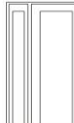
80 3/4" 80" 79 1/2"	6/6					
	6/8					
	8/0					

*Outswing not available.

Hand Designations	
(Viewed from the exterior)	
L	Left Hand
R	Right Hand
S	Vented Sidelite (hinged off jamb)

Inswing

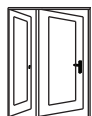

SL



SR

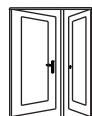





LS

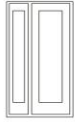
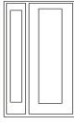
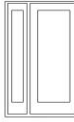
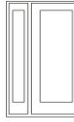

RS

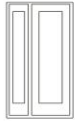
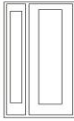
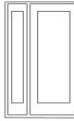
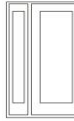
Single with 14" Venting Sidelite - Wide Mullion 6/6, 6/8, 8/0
Single with Venting Sidelite - Wide Mullion

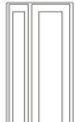
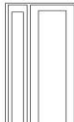
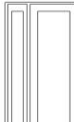
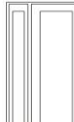
Brickmould Dim.	47 7/8"	49 7/8"	51 7/8"	53 7/8"	55 7/8"
Rough Opening	46 1/8"	48 1/8"	50 1/8"	52 1/8"	54 1/8"
Unit Dimension	45 3/8"	47 3/8"	49 3/8"	51 3/8"	53 3/8"
80 3/4" 80" 79 1/2"	 2/4	 2/6	 2/8	 2/10	 3/0
83 1/4" 82 1/2" 82"	 2/4	 2/6	 2/8	 2/10	 3/0
99 1/4" 98 1/2" 98"	 2/4	 2/6	 2/8	 2/10	 3/0

*Outswing not available.

Hand Designations	
<i>(Viewed from the exterior)</i>	
L	Left Hand
R	Right Hand
S	Vented Sidelite (hinged off jamb)

Inswing

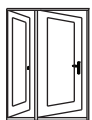

SL



SR

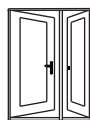

LS

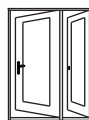

RS

Unit and Rough Opening Sizing

Single with 2-12" Venting Sidelites - Wide Mullion 6/6, 6/8, 8/0

Single with Venting Sidelites - Wide Mullion

Brickmould Dim.	59 9/16"	61 9/16"	63 9/16"	65 9/16"	67 9/16"		
Rough Opening	57 13/16"	59 13/16"	61 13/16"	63 13/16"	65 13/16"		
Unit Dimension	57 1/16"	59 1/16"	61 1/16"	63 1/16"	65 1/16"		
80 3/4" 80" 79 1/2"	6/6						
		2/4	2/6	2/8	2/10	3/0	
	83 1/4" 82 1/2" 82"	6/8					
			2/4	2/6	2/8	2/10	3/0
		99 1/4" 98 1/2" 98"	8/0				
			2/4	2/6	2/8	2/10	3/0

*Outswing not available.

Hand Designations	
(Viewed from the exterior)	
L	Left Hand
R	Right Hand
S	Sidelite

Inswing

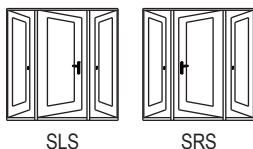

Unit and Rough Opening Sizing

Single with 2-14" Venting Sidelites - Wide Mullion 6/6, 6/8, 8/0

Single with Venting Sidelites - Wide Mullion

Brickmould Dim.	63 9/16"	65 9/16"	67 9/16"	69 9/16"	71 9/16"
Rough Opening	61 13/16"	63 13/16"	65 13/16"	67 13/16"	69 13/16"
Unit Dimension	61 1/16"	63 1/16"	65 1/16"	67 1/16"	69 1/16"

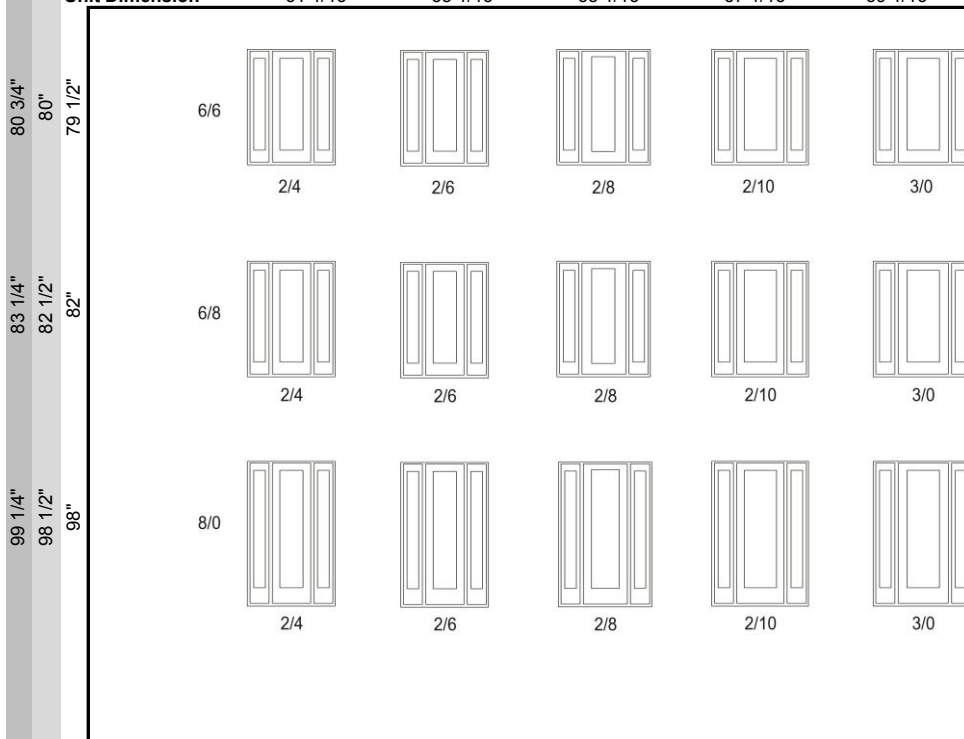

*Outswing not available.

Hand Designations	
(Viewed from the exterior)	
L	Left Hand
R	Right Hand
S	Sidelite

Inswing

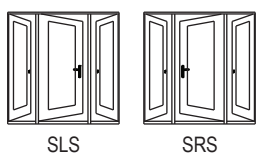

Unit and Rough Opening Sizing

French with 2-12" Venting Sidelites - Wide Mullion 6/6, 6/8, 8/0 French with Venting Sidelites - Wide Mullion

Brickmould Dim.	88 1/2"	92 1/2"	96 1/2"	100 1/2"	104 1/2"
Rough Opening	86 3/4"	90 3/4"	94 3/4"	98 3/4"	102 3/4"
Unit Dimension	86"	90"	94"	98"	102"
80 3/4"					
80"					
79 1/2"					
83 1/4"					
82 1/2"					
82"					
99 1/4"					
98 1/2"					
98"					

*Outswing not available.

Hand Designations	
(Viewed from the exterior)	
L	Left Hand
R	Right Hand
A	Astragal
S	Sidelite

Inswing

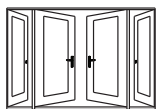

SLRS

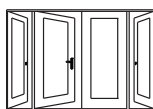

SLAS

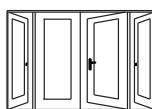

SARS

Unit and Rough Opening Sizing

French with 2-14" Venting Sidelites - Wide Mullion 6/6, 6/8, 8/0

French with Venting Sidelites - Wide Mullion

Brickmould Dim.	92 1/2"	96 1/2"	100 1/2"	104 1/2"	108 1/2"
Rough Opening	90 3/4"	94 3/4"	98 3/4"	102 3/4"	106 3/4"
Unit Dimension	90"	94"	98"	102"	106"

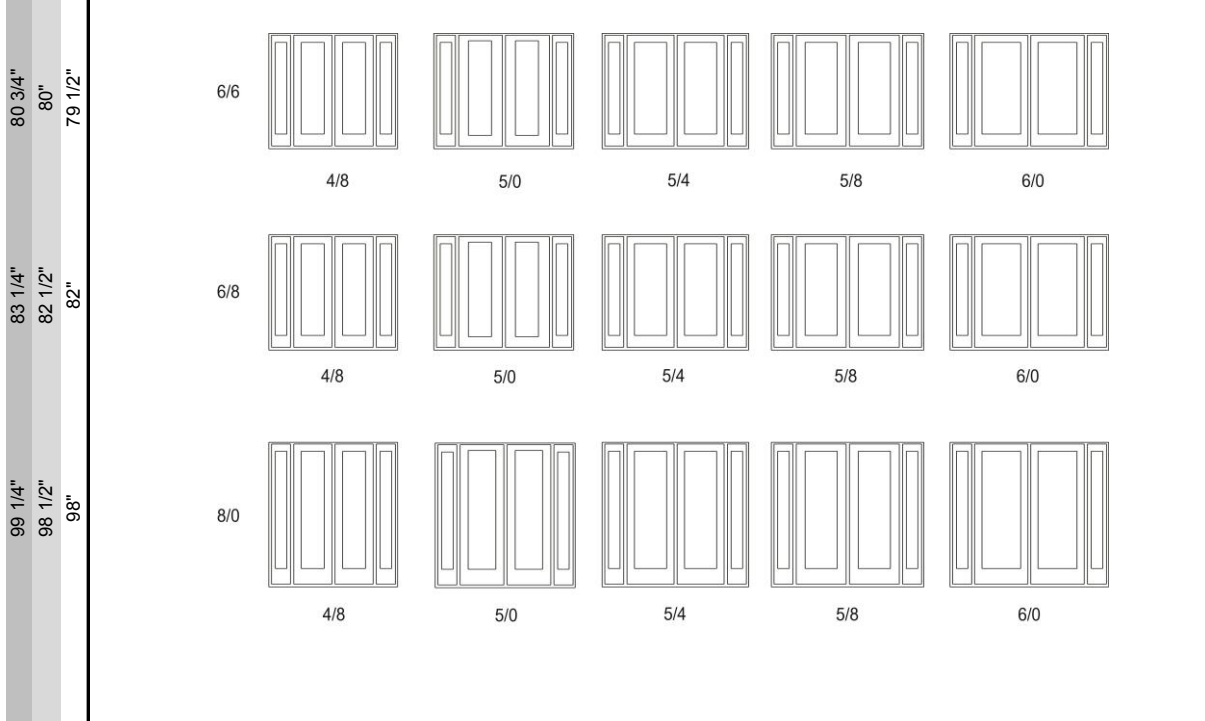

*Outswing not available.

Hand Designations (Viewed from the exterior)	
L	Left Hand
R	Right Hand
A	Astragal
S	Sidelite

Inswing

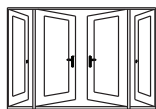

SLRS

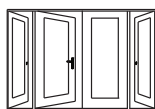

SLAS

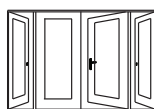

SARS

Unit and Rough Opening Sizing

Single Transoms

Unit Dimension 37 5/8" 13 1/2" 15 1/2"

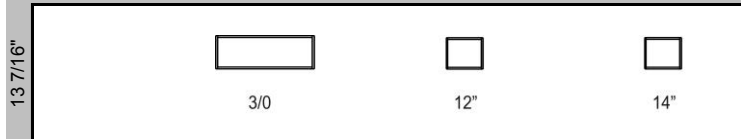

*Add actual unit dimension to door rough opening height for total rough opening height.

Double - Standard Continuous Mullion Transoms

Unit Dimension 62 13/16" 66 13/16" 70 13/16" 74 13/16"

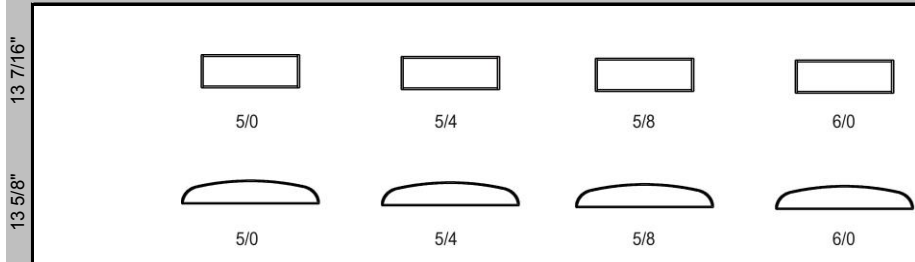

*Add actual unit dimension to door rough opening height for total rough opening height.

Single with 2 Sidelites - Boxed Transoms

Unit Dimension 64 5/8" 68 5/8"

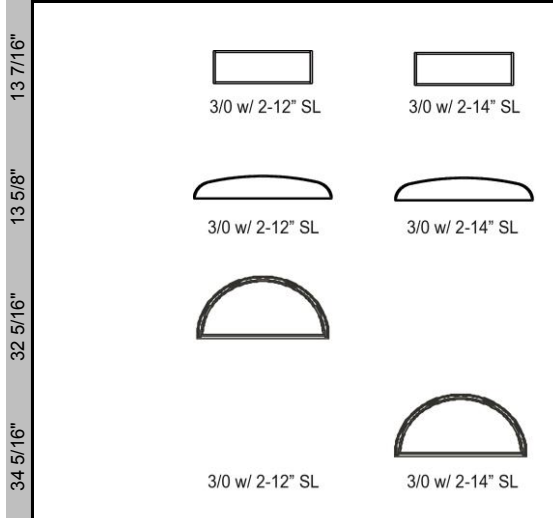

*Add actual unit dimension to door rough opening height for total rough opening height.

Single with 2 Sidelites - Continuous Transoms

Unit Dimension 63 5/8" 67 5/8"

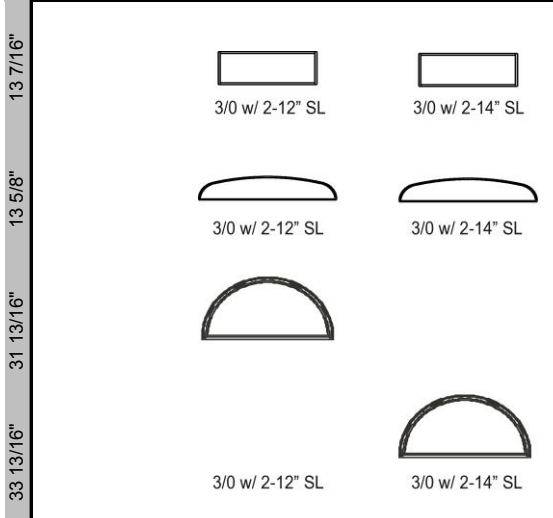

*Add actual unit dimension to door rough opening height for total rough opening height.

Single - 90 min. Fire Doors with Adjusta-Fit 2 Frames - 6/8, 7/0

Single

	27 11/32"	31 11/32"	33 11/32"	35 11/32"	37 11/32"	39 11/32"	45 11/32"						
Masonry R.O.	27 11/32"	31 11/32"	33 11/32"	35 11/32"	37 11/32"	39 11/32"	45 11/32"						
Drywall R.O.	25 1/16"	29 1/16"	31 1/16"	33 1/16"	35 1/16"	37 1/16"	43 1/16"						
Unit Dimension	27 11/32"	31 11/32"	33 11/32"	35 11/32"	37 11/32"	39 11/32"	45 11/32"						
82 23/32" 81 5/8" 82 23/32"								81 19/32"	82 3/32"	80 1/2"	81"	81 19/32"	82 3/32"
								85 19/32"	86 3/32"	84 1/2"	85"	85 19/32"	86 3/32"
86 23/32" 85 5/8" 86 23/32"								85 19/32"	86 3/32"	84 1/2"	85"	85 19/32"	86 3/32"
Inswing								No Sill	Public Access	No Sill	Public Access	No Sill	Public Access
Inswing								Public Access	Public Access	Public Access	Public Access	Public Access	Public Access
Inswing								No Sill	No Sill	No Sill	No Sill	No Sill	No Sill
	27 11/32"	31 11/32"	33 11/32"	35 11/32"	37 11/32"	39 11/32"	45 11/32"	Unit Dim.					
	25 1/16"	29 1/16"	31 1/16"	33 1/16"	35 1/16"	37 1/16"	43 1/16"	Drywall R.O.					
	29 27/32"	33 27/32"	35 27/32"	37 27/32"	39 27/32"	41 27/32"	47 27/32"	Masonry R.O.					

Single

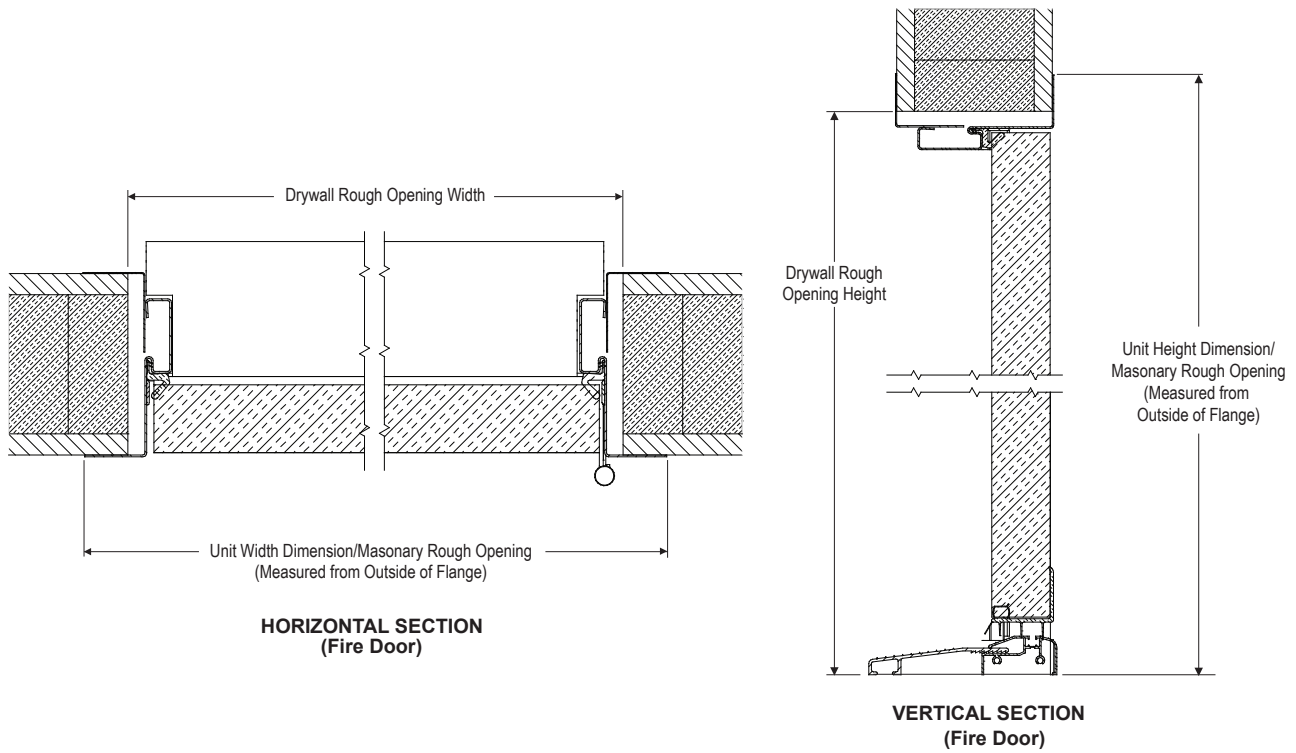

Unit and Rough Opening Sizing

Hinged Clear Opening

Door Panel	Clear Opening Width		Clear Opening Width Double w/ 7/8" Astragal		Clear Opening Width Double w/ 5/8" Astragal		Sq. Ft. Clear Opening Inswing		Sq. Ft. Clear Opening Inswing Dbl. w/ 7/8" Astragal		Sq. Ft. Clear Opening Outswing		Sq. Ft. Clear Opening Outswing Dbl. w/ 7/8" Astragal	
	90°	Full	90°	Full	90°	Full	90°	Full	90°	Full	90°	Full	90°	Full
12" Venting S/L 6/6	9"	11-3/16"	N/A	N/A	N/A	N/A	4.796	5.962	N/A	N/A	N/A	N/A	N/A	N/A
14" Venting S/L 6/6	11"	13-3/16"	N/A	N/A	N/A	N/A	5.862	7.027	N/A	N/A	N/A	N/A	N/A	N/A
2/4 6/6	25-5/16"	27-9/32"	52-13/32"	56-1/16"	52-5/32"	55-13/16"	13.61	14.52	28.08	29.91	13.41	14.32	27.68	29.48
2/6 6/6	27-5/16"	29-5/32"	56-13/32"	60-1/16"	56-5/32"	59-13/16"	14.58	15.56	30.09	32.05	14.37	15.34	29.66	31.59
2/8 6/6	29-5/16"	31-5/32"	60-13/32"	64-1/16"	60-5/32"	63-13/16"	15.65	16.63	32.23	34.18	15.42	16.39	31.77	33.69
2/10 6/6	31-5/16"	33-5/32"	64-13/32"	68-1/16"	64-5/32"	67-13/16"	16.72	17.69	34.37	36.32	16.47	17.44	33.87	35.80
3/0 6/6	33-5/16"	35-5/32"	68-13/32"	72-1/16"	68-5/32"	71-13/16"	17.78	18.76	36.50	38.46	17.53	18.49	35.97	37.90
2/4 6/8	25-5/16"	27-9/32"	52-13/32"	56-1/16"	52-5/32"	55-13/16"	14.05	14.52	29.02	30.90	13.86	14.80	28.62	30.47
2/6 6/8	27-5/16"	29-5/32"	56-13/32"	60-1/16"	56-5/32"	59-13/16"	15.06	16.07	31.09	33.11	14.85	15.85	30.66	32.65
2/8 6/8	29-5/16"	31-5/32"	60-13/32"	64-1/16"	60-5/32"	63-13/16"	16.17	17.18	33.30	35.32	15.94	16.94	32.84	34.83
2/10 6/8	31-5/16"	33-5/32"	64-13/32"	68-1/16"	64-5/32"	67-13/16"	17.27	18.28	35.50	37.53	17.03	18.03	35.01	37.00
3/0 6/8	33-5/16"	35-5/32"	68-13/32"	72-1/16"	68-5/32"	71-13/16"	18.37	19.38	37.71	39.73	18.12	19.11	37.18	39.18
12" Venting S/L 6/8	9"	11-3/16"	N/A	N/A	N/A	N/A	4.796	5.962	N/A	N/A	N/A	N/A	N/A	N/A
14" Venting S/L 6/8	11"	13-3/16"	N/A	N/A	N/A	N/A	5.862	7.027	N/A	N/A	N/A	N/A	N/A	N/A

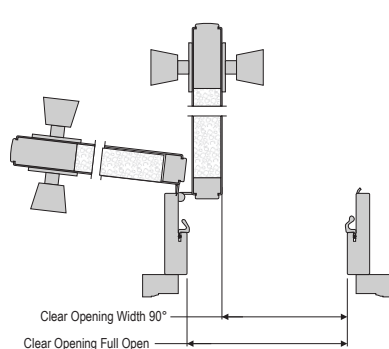

**HORIZONTAL SECTION
(Single)**

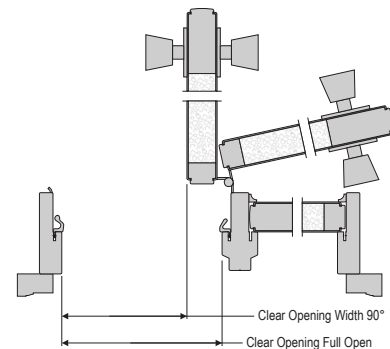

**HORIZONTAL SECTION
(Double/Triple - Operable panel
hinged off jamb or mullion)**

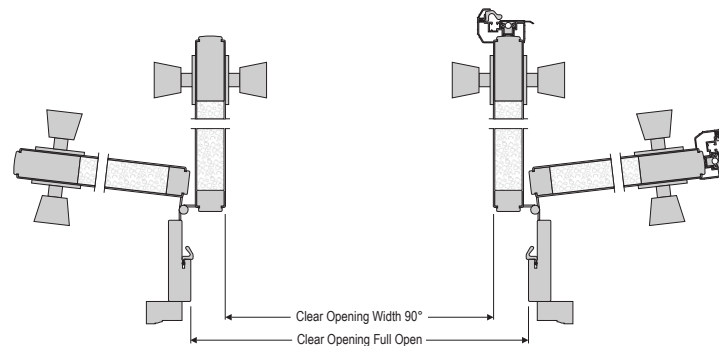

**HORIZONTAL SECTION
(French)
(Hinged off jamb or mullion)**

Unit and Rough Opening Sizing

Hinged Clear Opening

Door Panel	Composite Clear Opening Height Inswing	Basic Fixed Clear Opening Height Inswing	Bumper Clear Opening Height Outswing	Composite Clear Opening Height Outswing
2/4 6/6	76-3/4"	76-11/16"	77-1/4"	76-3/4"
2/6 6/6	76-3/4"	76-11/16"	77-1/4"	76-3/4"
2/8 6/6	76-3/4"	76-11/16"	77-1/4"	76-3/4"
2/10 6/6	76-3/4"	76-11/16"	77-1/4"	76-3/4"
3/0 6/6	76-3/4"	76-11/16"	77-1/4"	76-3/4"
2/4 6/8	79-1/4"	79-1/4"	79-3/4"	79-5/16"
2/6 6/8	79-1/4"	79-1/4"	79-3/4"	79-5/16"
2/8 6/8	79-1/4"	79-1/4"	79-3/4"	79-5/16"
2/10 6/8	79-1/4"	79-1/4"	79-3/4"	79-5/16"
3/0 6/8	79-1/4"	79-1/4"	79-3/4"	79-5/16"
2/4 8/0	95-1/4"	95-1/4"	95-3/4"	95-5/16"
2/6 8/0	95-1/4"	95-1/4"	95-3/4"	95-5/16"
2/8 8/0	95-1/4"	95-1/4"	95-3/4"	95-5/16"
2/10 8/0	95-1/4"	95-1/4"	95-3/4"	95-5/16"

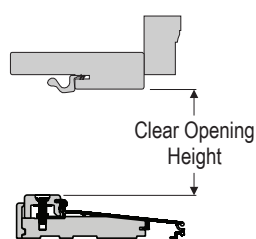

**VERTICAL SECTION
INSWING G**

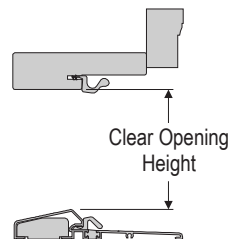

**VERTICAL SECTION
OUTSWING G**

Unit and Rough Opening Sizing

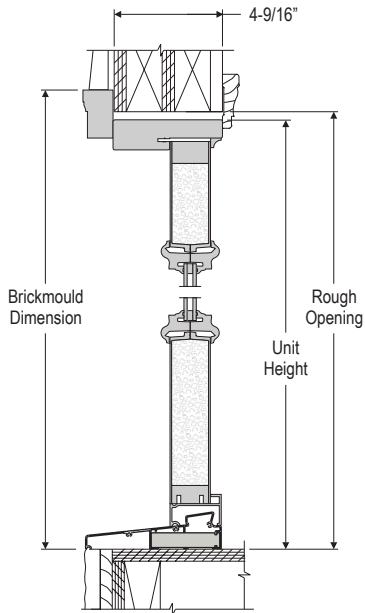

**VERTICAL SECTION
INSWING - FIXED**

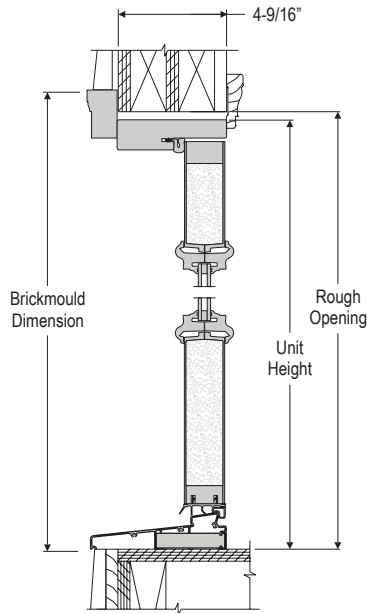

**VERTICAL SECTION
INSWING - SINGLE**

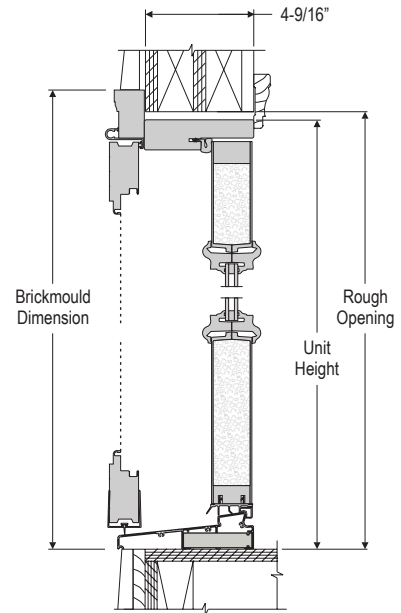

**VERTICAL SECTION
INSWING - DOUBLE w/ASTRAGAL
w/HINGED SCREEN**

Unit and Rough Opening Sizing

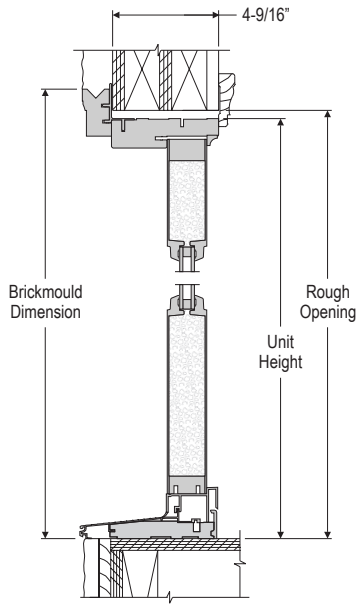

**VERTICAL SECTION
INSWING - FIXED**
(shown with Stucco Brickmould option)

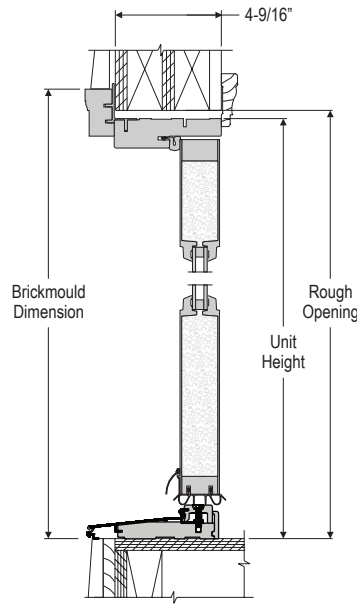

**VERTICAL SECTION
INSWING - SINGLE**

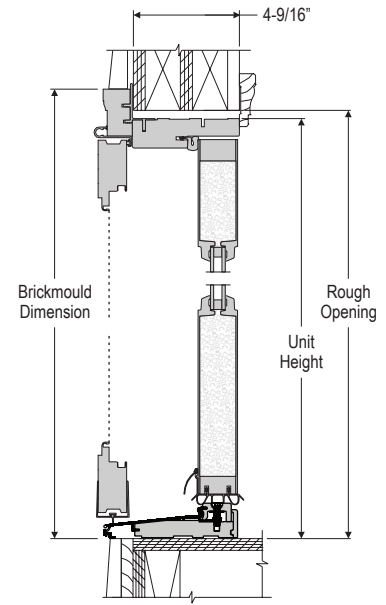

**VERTICAL SECTION
INSWING - DOUBLE w/ASTRAGAL
w/HINGED SCREEN**

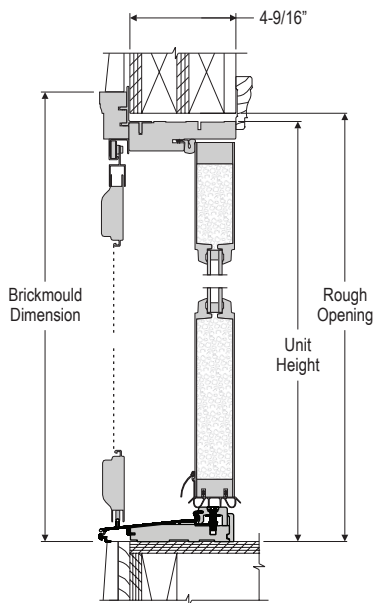

**VERTICAL SECTION
INSWING - DOUBLE/TRIPLE
w/TOP HUNG SCREEN**

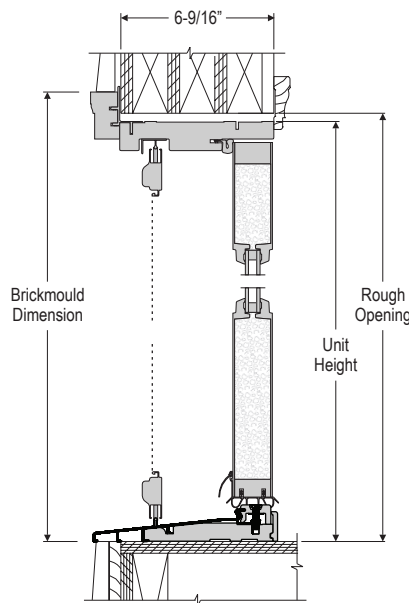

**VERTICAL SECTION
INSWING - 6-9/16"
w/STANDARD SCREEN**

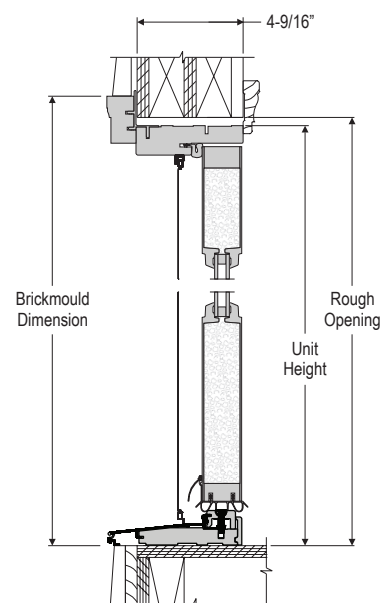

**VERTICAL SECTION
INSWING - VENTED SIDELITE
w/FIXED SCREEN**

Unit and Rough Opening Sizing

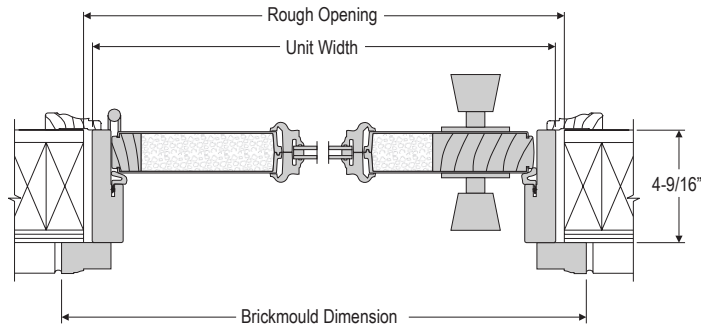

**HORIZONTAL SECTION
INSWING - SINGLE
(L shown)**

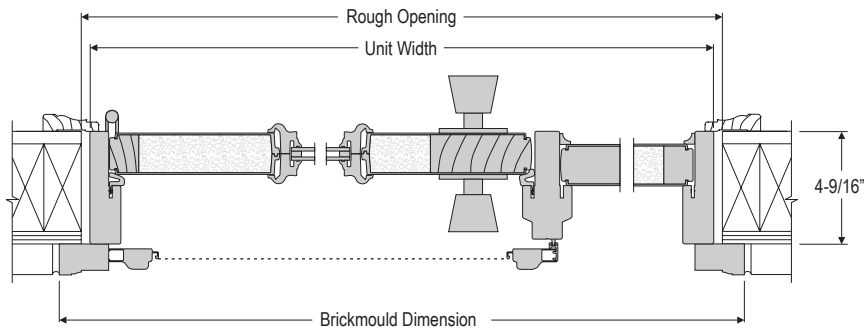

**HORIZONTAL SECTION
INSWING - DOUBLE w/MULLION
(LF shown)**

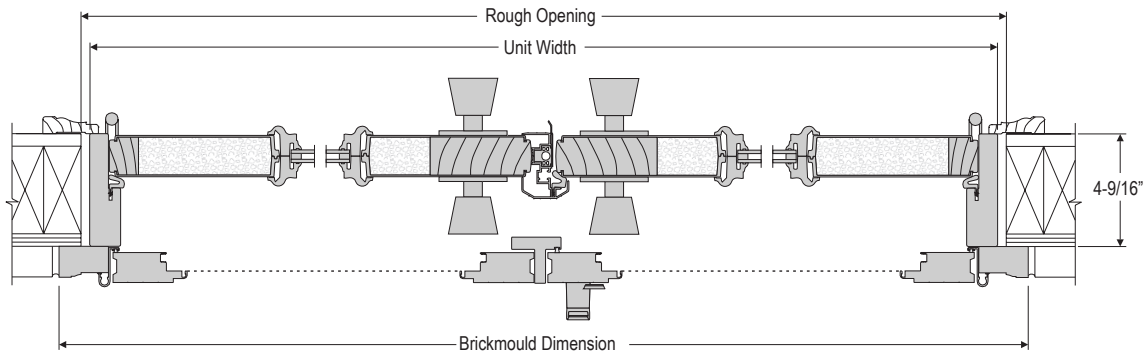

**HORIZONTAL SECTION
INSWING - DOUBLE w/ASTRAGAL
w/HINGED SCREEN
(AR shown)**

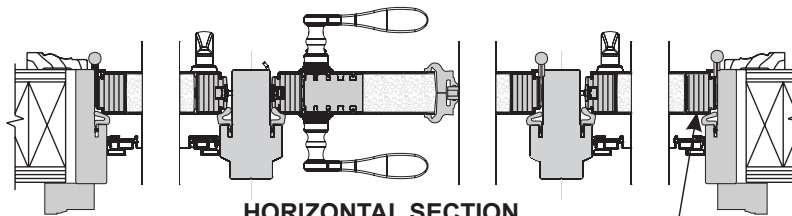

**HORIZONTAL SECTION
INSWING - SINGLE WITH VENTED SIDELITE
AND FIXED SCREEN
(LRR shown)**

Unit and Rough Opening Sizing

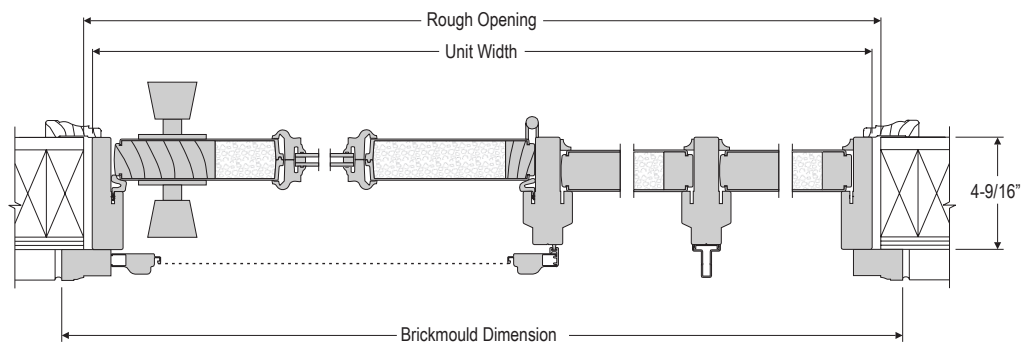

**HORIZONTAL SECTION
INSWING -TRIPLE
(RFF shown)**

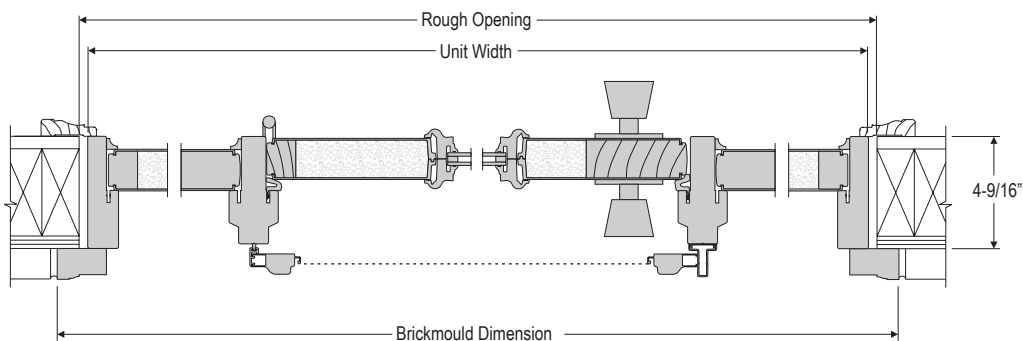

**HORIZONTAL SECTION
INSWING - TRIPLE
(FLF shown)**

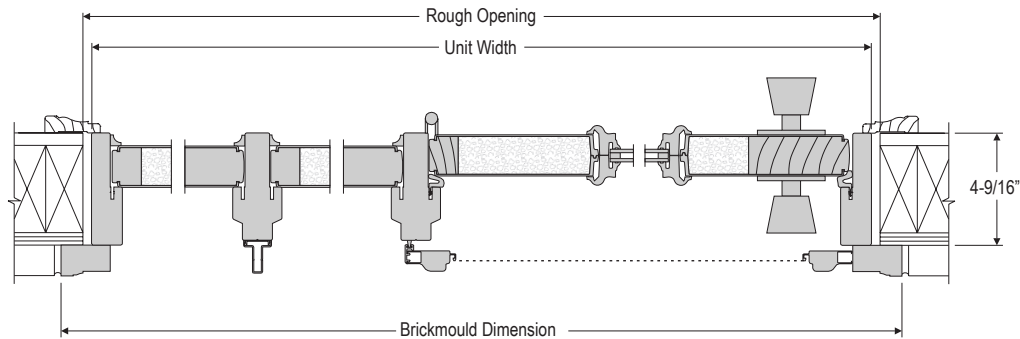

**HORIZONTAL SECTION
INSWING - TRIPLE
(FFL shown)**

Unit and Rough Opening Sizing

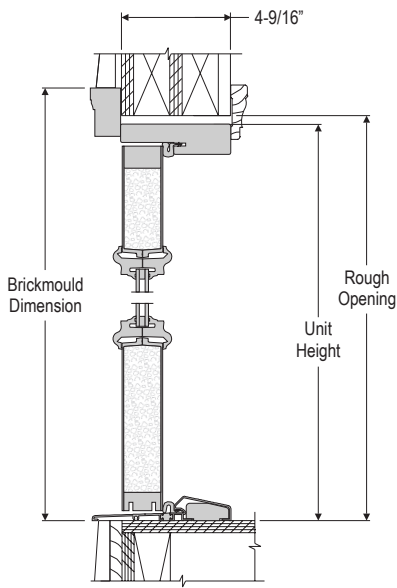

**VERTICAL SECTION
OUTSWING
THERMAL BREAK**

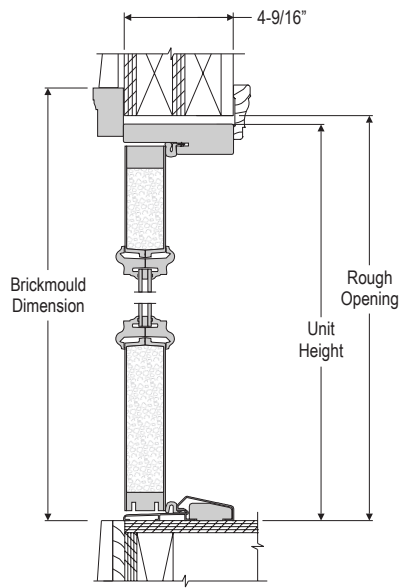

**VERTICAL SECTION
OUTSWING
NO THERMAL BREAK**

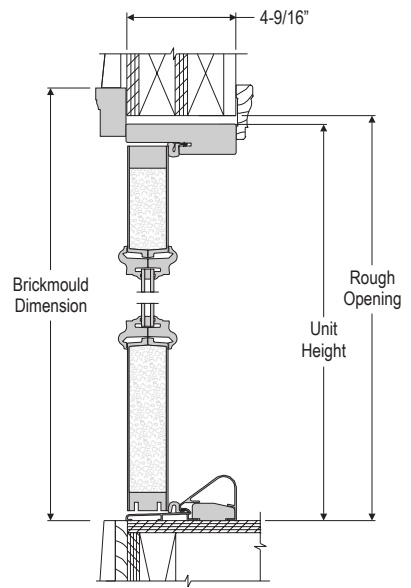

**VERTICAL SECTION
OUTSWING
COASTAL**

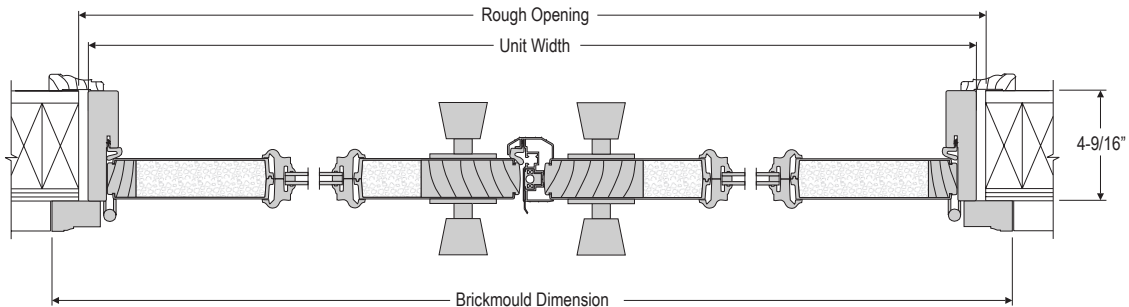

**HORIZONTAL SECTION
OUTSWING - DOUBLE w/ASTRAGAL
(RA shown)**

Unit and Rough Opening Sizing

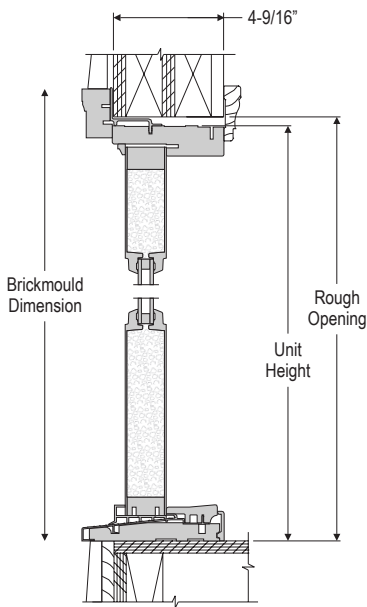

**VERTICAL SECTION
OUTSWING - FIXED**

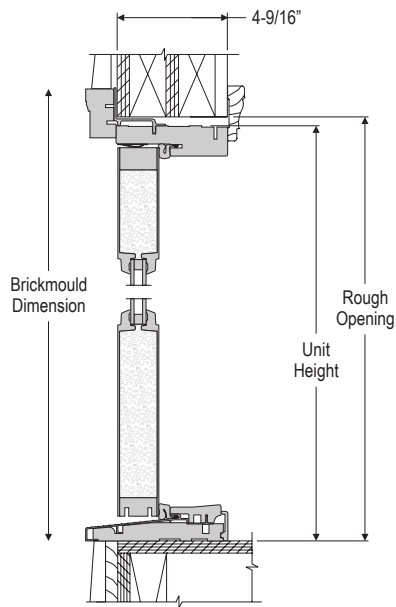

**VERTICAL SECTION
OUTSWING**

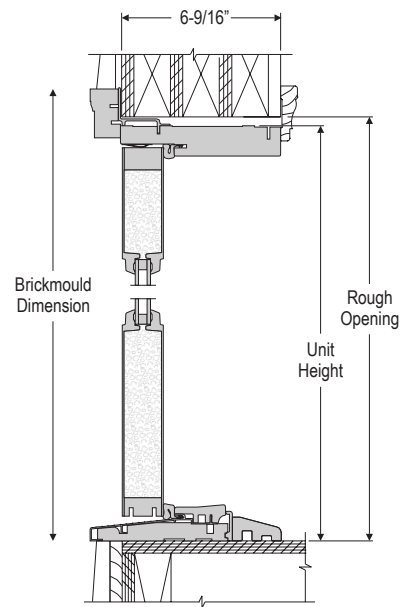

**VERTICAL SECTION
OUTSWING - 6-9/16\"/>**

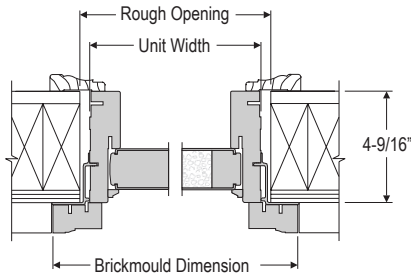

**HORIZONTAL SECTION
OUTSWING - FIXED**

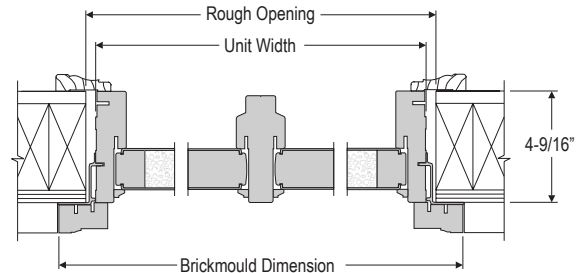

**HORIZONTAL SECTION
OUTSWING - FIXED/FIXED**

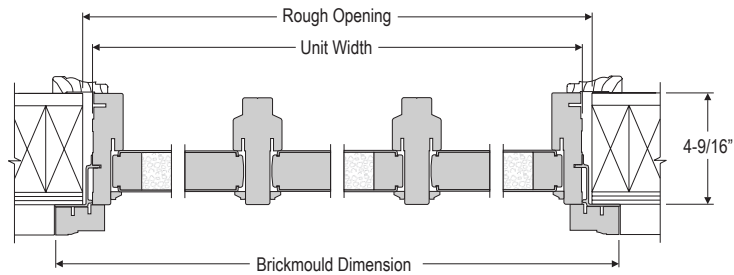

HORIZONTAL SECTION

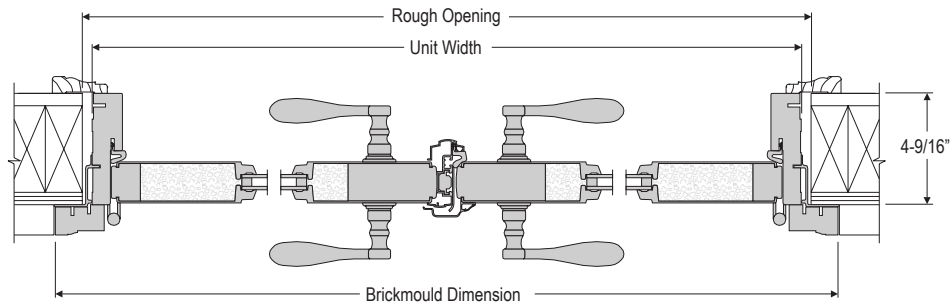

Unit and Rough Opening Sizing

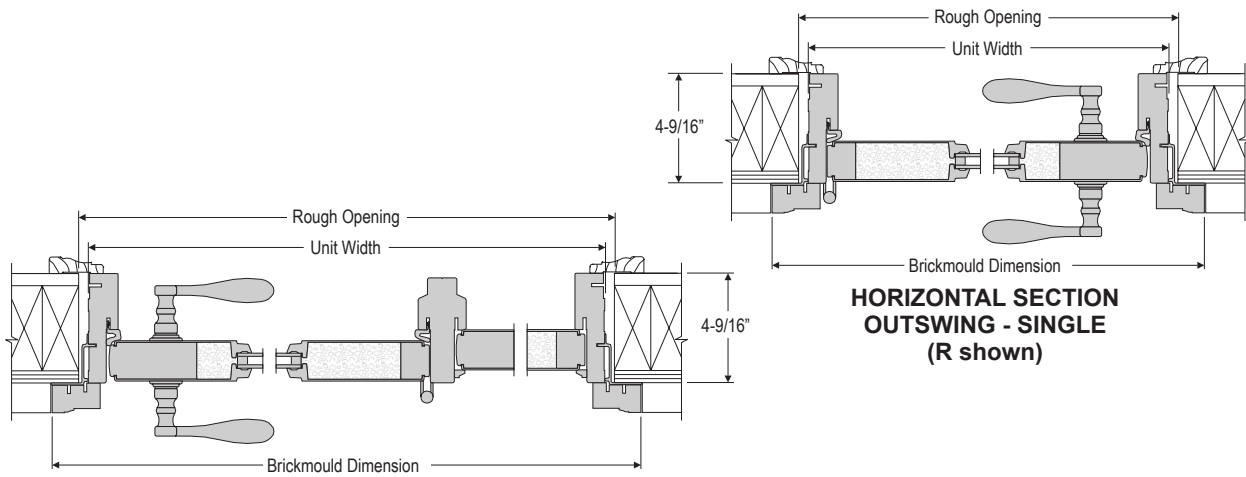

**HORIZONTAL SECTION
OUTSWING - DOUBLE w/MULLION
(LF shown)**

**HORIZONTAL SECTION
OUTSWING - SINGLE
(R shown)**

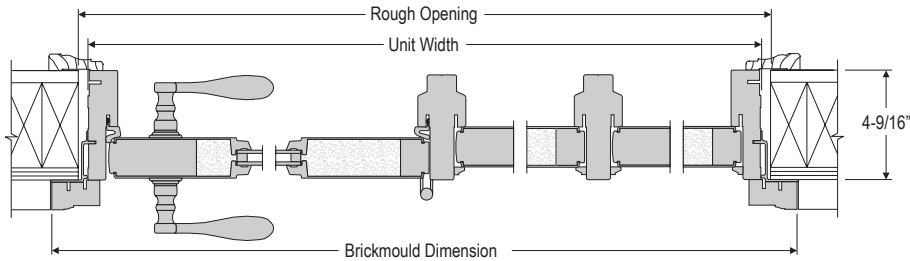

**HORIZONTAL SECTION
OUTSWING - TRIPLE
(LFF shown)**

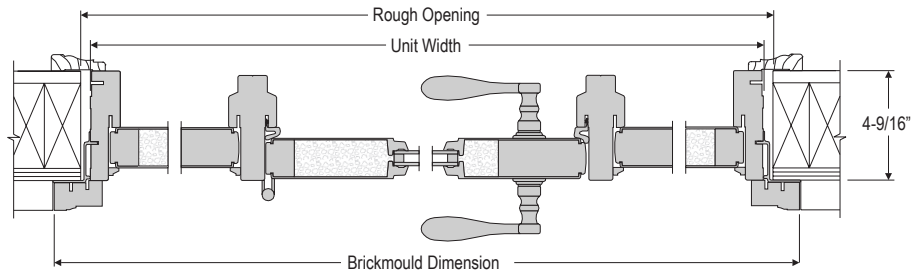

**HORIZONTAL SECTION
OUTSWING - TRIPLE
(FRF shown)**

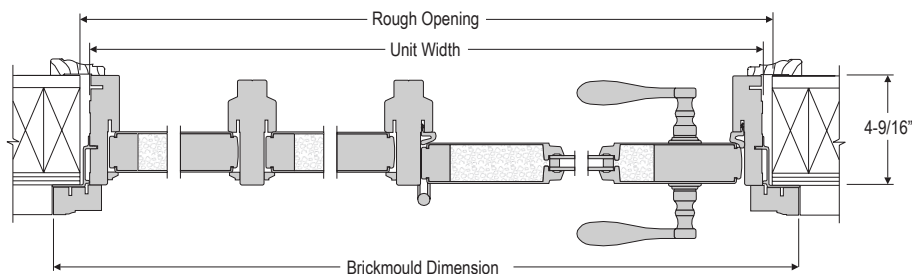

**HORIZONTAL SECTION
OUTSWING - TRIPLE
(FFR shown)**

Full Lite Panel Dimensions

Fiber-Classic® Full Lite Flush-Glazed - Panel Size

Door Panel	Panel Width	Panel Height	A	B	C	Daylight Width	Daylight Height	Sq. Ft. Daylight Opening		
								Single	Double	Triple
2/0 6/6	24	76 11/16	4 1/4	4 9/16	7 25/32	14 1/4	63 1/8	6.25	12.50	18.75
2/6 6/6	30	76 11/16	4 3/8	4 23/32	7 19/32	20 1/32	63 1/8	8.78	17.56	26.31
2/8 6/6	32	76 11/16	5 3/8	4 23/32	7 19/32	20 1/32	63 1/8	8.78	17.56	26.31
2/10 6/6	34	76 11/16	3 13/32	4 23/32	7 17/32	25 31/32	63 3/16	11.38	22.78	34.16
3/0 6/6	36	76 11/16	4 13/32	4 23/32	7 17/32	25 31/32	63 3/16	11.38	22.78	34.16
2/0 6/8	24	79 1/4	4 1/4	4 9/16	10 5/16	14 1/4	63 1/8	6.25	12.50	18.75
2/6 6/8	30	79 1/4	4 3/8	4 23/32	10 5/32	20 1/32	63 1/8	8.78	17.56	26.31
2/8 6/8	32	79 1/4	5 3/8	4 23/32	10 5/32	20 1/32	63 1/8	8.78	17.56	26.31
2/10 6/8	34	79 1/4	3 13/32	4 23/32	10 3/32	25 31/32	63 3/16	11.38	22.78	34.16
3/0 6/8	36	79 1/4	4 13/32	4 23/32	10 3/32	25 31/32	63 3/16	11.38	22.78	34.16
2/0 8/0	24	95 1/4	4 1/4	5 17/32	9 21/32	14 1/4	78 13/16	7.81	15.59	23.41
2/6 8/0	30	95 1/4	4 15/32	5 17/32	9 21/32	19 13/16	78 13/16	10.84	21.69	32.53
2/8 8/0	32	95 1/4	5 15/32	5 17/32	9 21/32	19 13/16	78 13/16	10.84	21.69	32.53
2/10 8/0	34	95 1/4	4 15/32	5 17/32	9 21/32	23 13/16	78 13/16	13.03	26.06	39.09
3/0 8/0	36	95 1/4	5 15/32	5 17/32	9 21/32	23 13/16	78 13/16	13.03	26.06	39.09

Smooth-Star® Full Lite Flush-Glazed - Panel Size

Door Panel	Panel Width	Panel Height	A	B	C	Daylight Width	Daylight Height	Sq. Ft. Daylight Opening		
								Single	Double	Triple
2/0 6/6	24	76 11/16	4 1/4	4 19/32	7 3/4	14 1/4	63 1/8	6.25	12.50	18.72
2/6 6/6	30	76 11/16	4 3/8	4 9/16	7 25/32	19 31/32	63 1/8	8.75	17.53	26.28
2/8 6/6	32	76 11/16	5 3/8	4 9/16	7 25/32	19 31/32	63 1/8	8.75	17.53	26.28
2/10 6/6	34	76 11/16	4 5/16	4 9/16	7 25/32	24 3/32	63 1/8	10.56	21.13	31.69
3/0 6/6	36	76 11/16	5 5/16	4 9/16	7 25/32	24 3/32	63 1/8	10.56	21.13	31.69
2/0 6/8	24	79 1/4	4 1/4	4 19/32	10 9/32	14 1/4	63 1/8	6.25	12.50	18.72
2/6 6/8	30	79 1/4	4 3/8	4 9/16	10 5/16	19 31/32	63 1/8	8.75	17.53	26.28
2/8 6/8	32	79 1/4	5 3/8	4 9/16	10 5/16	19 31/32	63 1/8	8.75	17.53	26.28
2/10 6/8	34	79 1/4	4 5/16	4 9/16	10 5/16	24 3/32	63 1/8	10.56	21.13	31.69
3/0 6/8	36	79 1/4	5 5/16	4 9/16	10 5/16	24 3/32	63 1/8	10.56	21.13	31.69
2/0 8/0	24	95 1/4	4 1/4	5 17/32	9 21/32	14 1/4	78 13/16	7.81	15.59	23.41
2/6 8/0	30	95 1/4	4 15/32	5 17/32	9 21/32	19 27/32	78 13/16	10.84	21.72	32.56
2/8 8/0	32	95 1/4	5 15/32	5 17/32	9 21/32	19 27/32	78 13/16	10.84	21.72	32.56
2/10 8/0	34	95 1/4	4 25/32	5 17/32	9 21/32	23 3/16	78 13/16	12.69	25.38	38.06
3/0 8/0	36	95 1/4	5 25/32	5 17/32	9 21/32	23 3/16	78 13/16	12.69	25.38	38.06

Full Lite Panel Dimensions

FLUSH-GLAZED

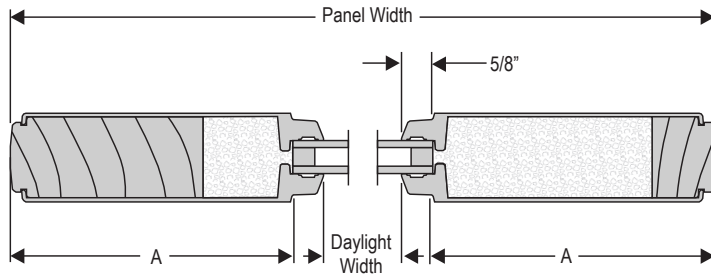

HORIZONTAL PANEL SECTION

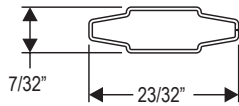

GBG GRILLE SECTION

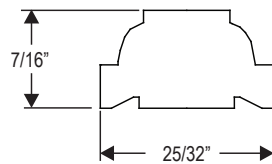

WOOD GRILLE SECTION

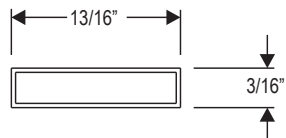

GBG GRILLE SECTION

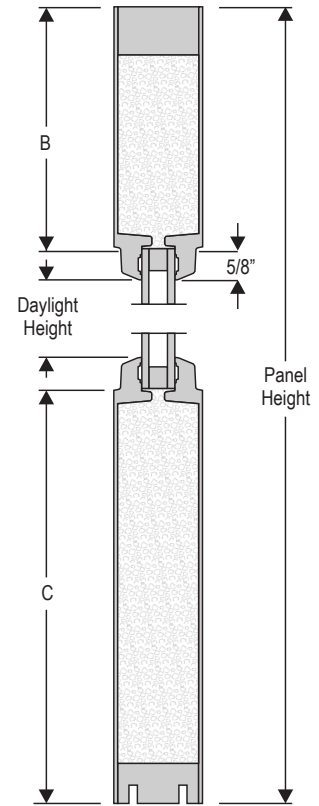

VERTICAL PANEL SECTION

Full Lite Panel Dimensions

Fiber Classic, Smooth-Star, and Steel with Scroll Lite Frame - Panel Size

Door Panel	Panel Width	Panel Height	A	B	C	Frame Width	Frame Height	Daylight Width	Daylight Height	Sq. Ft. Daylight Opening		
										Single	Double	Triple
2/4 6/6	28	76 11/16	5 1/32	4 5/32	6 17/32	17 31/32	65 31/32	14 31/32	62 31/32	6.53	13.06	19.63
2/6 6/6	30	76 11/16	4 1/16	4 5/32	6 21/32	21 29/32	65 29/32	18 29/32	62 29/32	8.25	16.50	24.78
2/8 6/6	32	76 11/16	5 1/16	4 5/32	6 21/32	21 29/32	65 29/32	18 29/32	62 29/32	8.25	16.50	24.78
2/10 6/6	34	76 11/16	5 1/16	4 5/32	6 21/32	23 7/8	65 7/8	20 15/16	62 15/16	9.16	18.28	27.44
3/0 6/6	36	76 11/16	6 1/16	4 5/32	6 21/32	23 7/8	65 7/8	20 15/16	62 15/16	9.16	18.28	27.44
2/4 6/8	28	79 1/4	5 1/32	4 5/32	9 3/32	17 31/32	65 31/32	14 31/32	62 31/32	6.53	13.06	19.63
2/6 6/8	30	79 1/4	4 1/16	4 5/32	9 7/32	21 29/32	65 29/32	18 29/32	62 29/32	8.25	16.50	24.78
2/8 6/8	32	79 1/4	5 1/16	4 5/32	9 7/32	21 29/32	65 29/32	18 29/32	62 29/32	8.25	16.50	24.78
2/10 6/8	34	79 1/4	5 1/16	4 5/32	9 7/32	23 7/8	65 7/8	20 15/16	62 15/16	9.16	18.28	27.44
3/0 6/8	36	79 1/4	6 1/16	4 5/32	9 7/32	23 7/8	65 7/8	20 15/16	62 15/16	9.16	18.28	27.44

SCROLL LITE FRAME

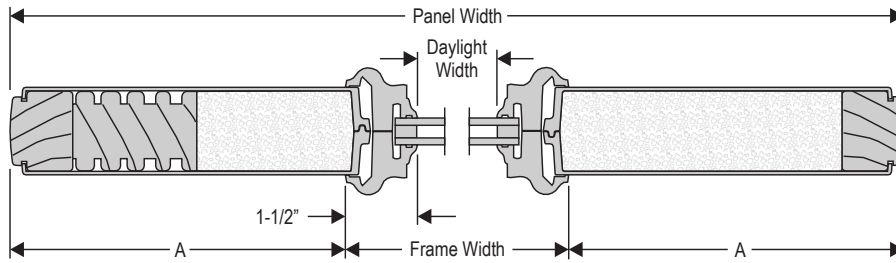

FIBER CLASSIC AND SMOOTH-STAR HORIZONTAL PANEL SECTION

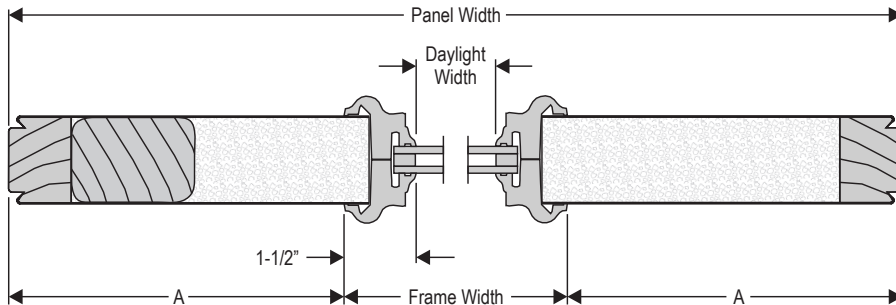

STEEL HORIZONTAL PANEL SECTION

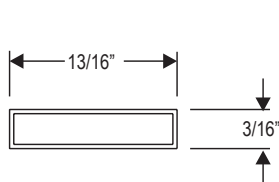

FLAT BAR
GBG GRILLE SECTION

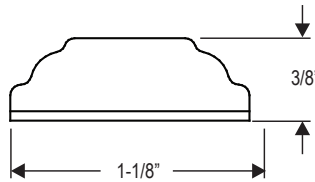

EXTERNAL GRILLE SECTION

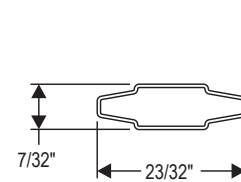

CONTOUR
GBG GRILLE SECTION

Full Lite Panel Dimensions

Fiber-Classic® and Smooth-Star® with Scroll Lite Frame - Panel Size

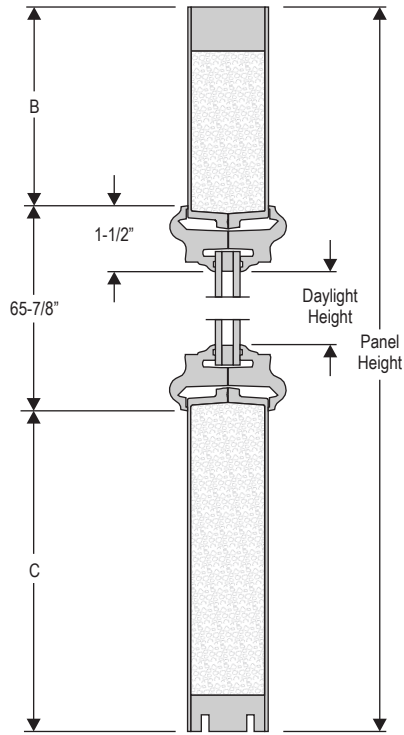

VERTICAL PANEL SECTION 2/6-3/0

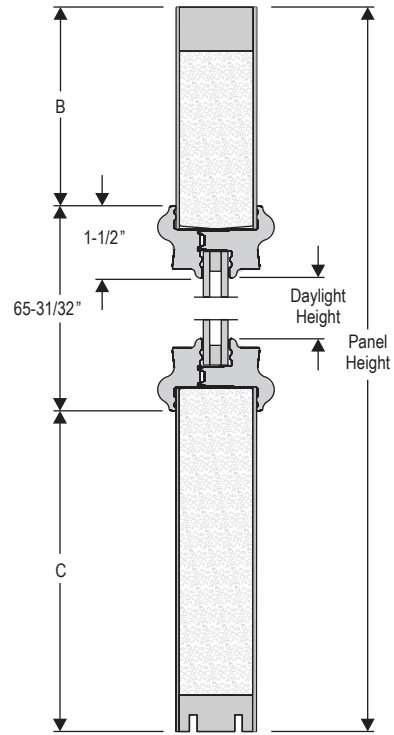

VERTICAL PANEL SECTION 2/4

Steel with Scroll Lite Frame - Panel Size

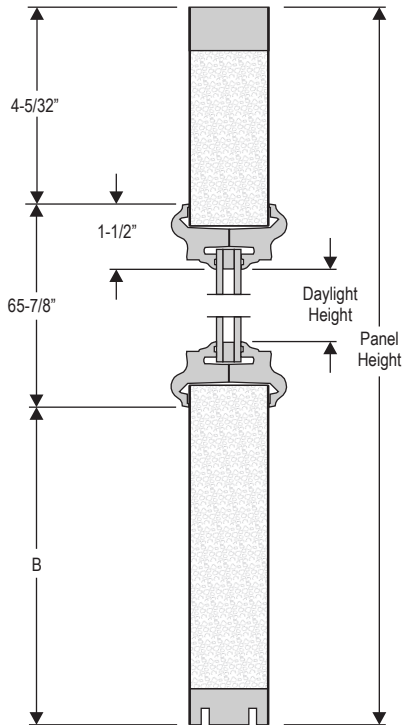

VERTICAL PANEL SECTION 2/6-3/0

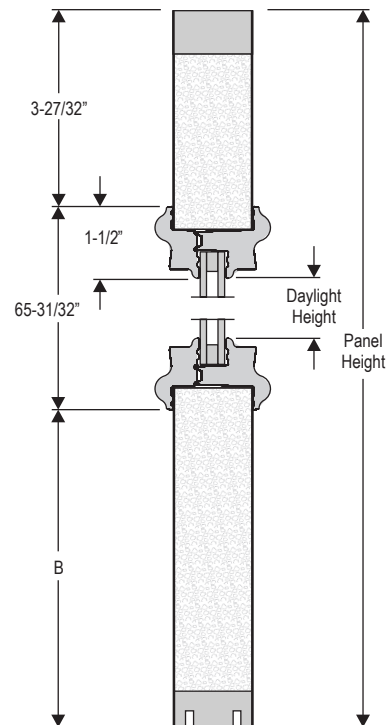

VERTICAL PANEL SECTION 2/4

Full Lite Panel Dimensions

Smooth-Star® Noise Reduction Lite - Panel Size

Door Panel	Panel Width	Panel Height	A	B	C	Frame Width	Frame Height	Daylight Width	Daylight Height	Sq. Ft. Daylight Opening		
										Single	Double	Triple
2/6 6/6	30	76 11/16	4 1/16	4 5/32	6 21/32	21 29/32	65 29/32	18 29/32	62 29/32	8.25	16.50	24.78
2/8 6/6	32	76 11/16	5 1/16	4 5/32	6 21/32	21 29/32	65 29/32	18 29/32	62 29/32	8.25	16.50	24.78
2/10 6/6	34	76 11/16	5 1/16	4 5/32	6 21/32	23 7/8	65 7/8	20 15/16	62 15/16	9.16	18.28	27.44
3/0 6/6	36	76 11/16	6 1/16	4 5/32	6 21/32	23 7/8	65 7/8	20 15/16	62 15/16	9.16	18.28	27.44
2/6 6/8	30	79 1/4	4 1/16	4 5/32	9 7/32	21 29/32	65 29/32	18 29/32	62 29/32	8.25	16.50	24.78
2/8 6/8	32	79 1/4	5 1/16	4 5/32	9 7/32	21 29/32	65 29/32	18 29/32	62 29/32	8.25	16.50	24.78
2/10 6/8	34	79 1/4	5 1/16	4 5/32	9 7/32	23 7/8	65 7/8	20 15/16	62 15/16	9.16	18.28	27.44
3/0 6/8	36	79 1/4	6 1/16	4 5/32	9 7/32	23 7/8	65 7/8	20 15/16	62 15/16	9.16	18.28	27.44
2/6 x 6/8 Elevated Cutout	30	79 1/4	4 1/16	4 5/32	9 7/32	21 29/32	65 29/32	18 29/32	62 29/32	8.25	16.50	24.78
2/8 x 6/8 Elevated Cutout	32	79 1/4	5 1/16	4 5/32	9 7/32	21 29/32	65 29/32	18 29/32	62 29/32	8.25	16.50	24.78
2/10 x 6/8 Elevated Cutout	34	79 1/4	5 1/16	4 5/32	9 7/32	23 7/8	65 7/8	20 15/16	62 15/16	9.16	18.28	27.44
3/0 x 6/8 Elevated Cutout	36	79 1/4	6 1/16	4 5/32	9 7/32	23 7/8	65 7/8	20 15/16	62 15/16	9.16	18.28	27.44
2/6 7/0	30	83 1/4	4 1/16	4 5/32	13 7/32	21 29/32	65 29/32	18 29/32	62 29/32	8.25	16.50	24.78
2/8 7/0	32	83 1/4	5 1/16	4 5/32	13 7/32	21 29/32	65 29/32	18 29/32	62 29/32	8.25	16.50	24.78
2/10 7/0	34	83 1/4	5 1/16	4 5/32	13 7/32	23 7/8	65 7/8	20 15/16	62 15/16	9.16	18.28	27.44
3/0 7/0	36	83 1/4	6 1/16	4 5/32	13 7/32	23 7/8	65 7/8	20 15/16	62 15/16	9.16	18.28	27.44
2/6 x 7/6 Elevated Cutout	30	89 1/4	3 15/16	2 31/32	4 5/32	22 1/8	82 1/8	18 29/32	78 29/32	10.38	20.75	31.13
2/8 x 7/6 Elevated Cutout	32	89 1/4	4 15/16	2 31/32	4 5/32	22 1/8	82 1/8	18 29/32	78 29/32	10.38	20.75	31.13
2/10 x 7/6 Elevated Cutout	34	89 1/4	4 15/16	2 31/32	4 5/32	24 1/8	82 1/8	20 29/32	78 29/32	11.47	22.94	34.41
3/0 x 7/6 Elevated Cutout	36	89 1/4	5 15/16	2 31/32	4 5/32	24 1/8	82 1/8	20 29/32	78 29/32	11.47	22.94	34.41
2/6 8/0	30	95 1/4	3 15/16	5 1/8	8	22 1/8	82 1/8	18 29/32	78 29/32	10.38	20.75	31.13
2/8 8/0	32	95 1/4	4 15/16	5 1/8	8	22 1/8	82 1/8	18 29/32	78 29/32	10.38	20.75	31.13
2/10 8/0	34	95 1/4	4 15/16	5 1/8	8	24 1/8	82 1/8	20 29/32	78 29/32	11.47	22.94	34.41
3/0 8/0	36	95 1/4	5 15/16	5 1/8	8	24 1/8	82 1/8	20 29/32	78 29/32	11.47	22.94	34.41
2/6 x 8/0 Elevated Cutout	30	95 1/4	3 15/16	2 31/32	10 5/32	22 1/8	82 1/8	18 29/32	78 29/32	10.38	20.75	31.13
2/8 x 8/0 Elevated Cutout	32	95 1/4	4 15/16	2 31/32	10 5/32	22 1/8	82 1/8	18 29/32	78 29/32	10.38	20.75	31.13
2/10 x 8/0 Elevated Cutout	34	95 1/4	4 15/16	2 31/32	10 5/32	24 1/8	82 1/8	20 29/32	78 29/32	11.47	22.94	34.41
3/0 x 8/0 Elevated Cutout	36	95 1/4	5 15/16	2 31/32	10 5/32	24 1/8	82 1/8	20 29/32	78 29/32	11.47	22.94	34.41

SMOOTH-STAR NOISE REDUCTION LITE

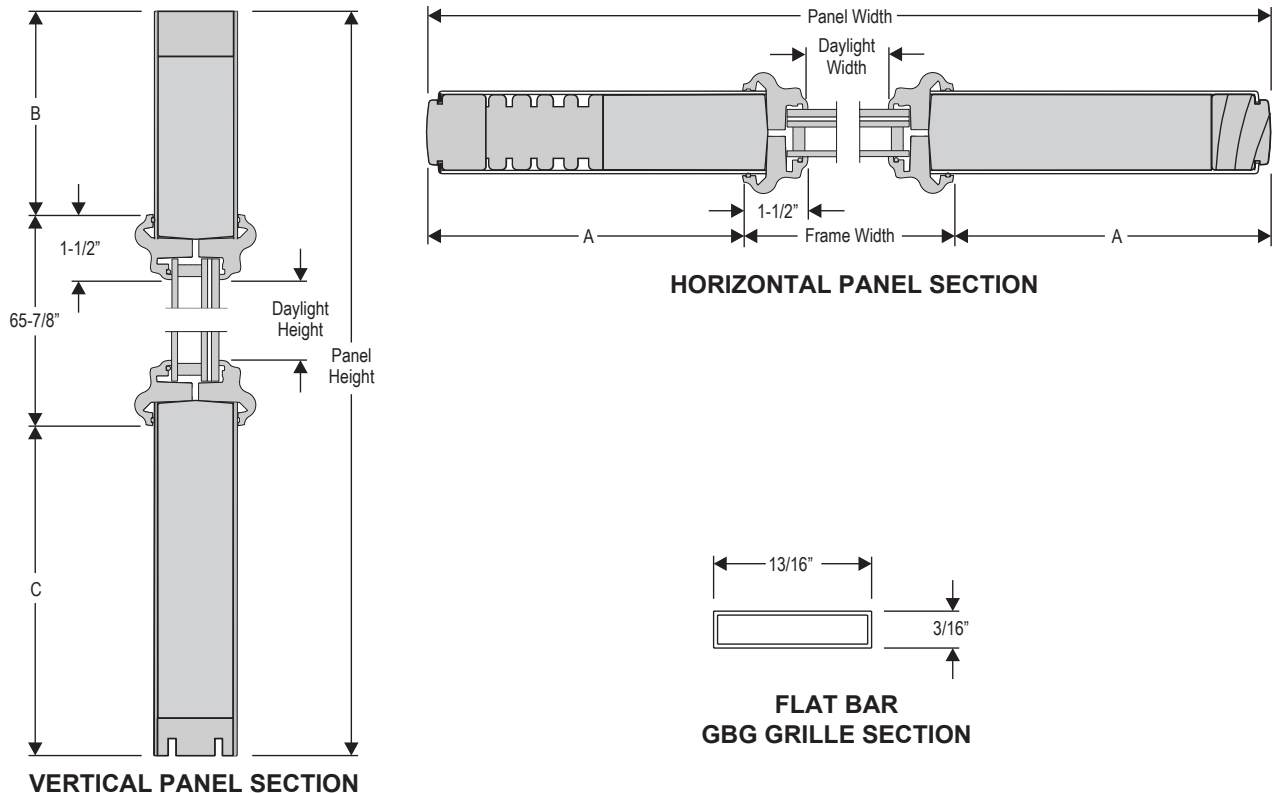

Full Lite Panel Dimensions

Classic-Craft® with Lite - Panel Size

Door Panel	Panel Width	Panel Height	Daylight Width	Daylight Height	Sq. Ft. Daylight Opening		
					Single	Double	Triple
3/0 6/8	35-5/16"	79-1/4"	24-17/32"	65-9/32"	11.12	22.24	33.36

CLASSIC-CRAFT

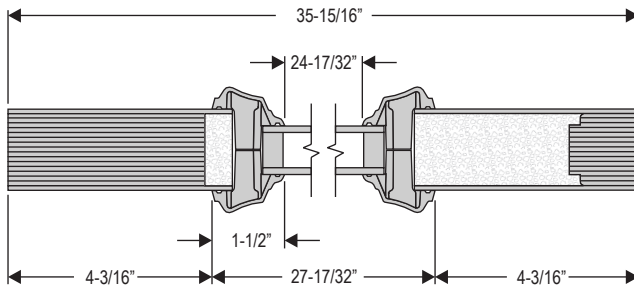

HORIZONTAL PANEL SECTION

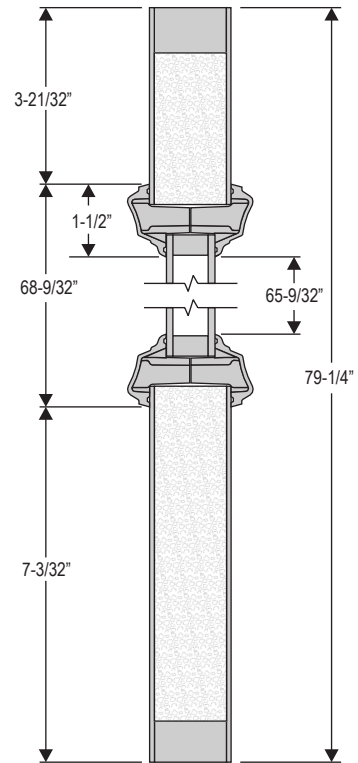

VERTICAL PANEL SECTION

6/8 Lip Lite Grille Locations

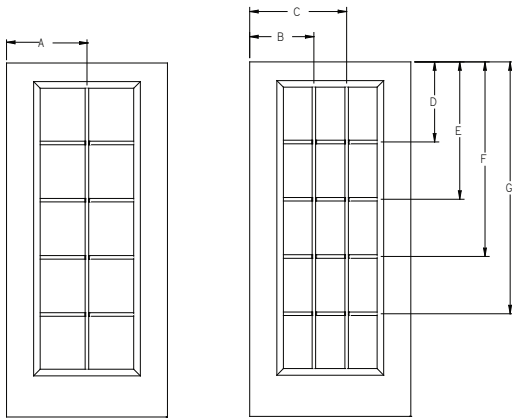

GBG/SDL - Lip Lite - 6'8" Full Lite - 3W5H and 2W5H

Panel	Glass	A	B	C	D	E	F	G
*2/4	16 x 64	14"	11-5/16"	16-11/16"	17-7/8"	30-11/16"	43-1/2"	56-5/16"
2/6	20 x 64	15"	11-11/16"	18-5/16"	17-7/8"	30-11/16"	43-1/2"	56-5/16"
2/8	22 x 64	16"	12-5/16"	19-11/16"	17-7/8"	30-11/16"	43-1/2"	56-5/16"
2/10	22 x 64	17"	13-5/16"	20-11/16"	17-7/8"	30-11/16"	43-1/2"	56-5/16"
3/0	22 x 64	18"	14-5/16"	21-11/16"	17-7/8"	30-11/16"	43-1/2"	56-5/16"

*SDL not available.

Wood Grilles - Lip Lite - 6'8" Full Lite - 3W5H and 2W5H

Panel	Glass	A	B	C	D	E	F	G
2/6	20 x 64	15"	11-13/16"	18-3/16"	18-3/16"	30-13/16"	43-3/8"	56"
2/8	22 x 64	16"	12-1/2"	19-1/2"	18-3/16"	30-13/16"	43-3/8"	56"
2/10	22 x 64	17"	13-1/2"	20-1/2"	18-3/16"	30-13/16"	43-3/8"	56"
3/0	22 x 64	18"	14-1/2"	21-1/2"	18-3/16"	30-13/16"	43-3/8"	56"

Fixed Grilles - Lip Lite - 6'8" Full Lite - 3W5H and 2W5H

Panel	Glass	A	B	C	D	E	F	G
2/6	20 x 64	15"	11-11/16"	18-5/16"	17-15/16"	30-11/16"	43-1/2"	56-1/4"
2/8	22 x 64	16"	12-3/8"	19-5/8"	17-15/16"	30-11/16"	43-1/2"	56-1/4"
2/10	22 x 64	17"	13-3/8"	20-5/8"	17-15/16"	30-11/16"	43-1/2"	56-1/4"
3/0	22 x 64	18"	14-3/8"	21-5/8"	17-15/16"	30-11/16"	43-1/2"	56-1/4"

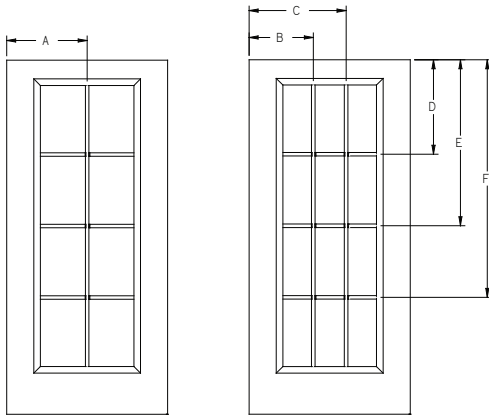

GBG - Lip Lite - 6'8" Full Lite - 3W4H and 2W4H

Panel	Glass	A	B	C	D	E	F
2/4	16 x 64	14"	11-5/16"	16-11/16"	21-3/16"	37-3/16"	53-3/16"
2/6	20 x 64	15"	11-11/16"	18-5/16"	21-1/8"	37-1/8"	53-1/8"
2/8	22 x 64	16"	12-5/16"	19-11/16"	21-1/8"	37-1/8"	53-1/8"
2/10	22 x 64	17"	13-5/16"	20-11/16"	21-1/8"	37-1/8"	53-1/8"
3/0	22 x 64	18"	14-5/16"	21-11/16"	21-1/8"	37-1/8"	53-1/8"

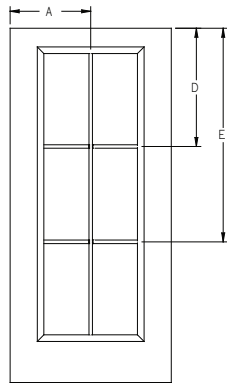

GBG - Lip Lite - 6'8" Full Lite - 2W3H

Panel	Glass	A	B	C	D	E
2/4	16 x 64	14"	-	-	26-1/2"	47-7/8"
2/6	20 x 64	15"	-	-	26-7/16"	47-3/4"
2/8	22 x 64	16"	-	-	26-7/16"	47-3/4"
2/10	22 x 64	17"	-	-	26-7/16"	47-3/4"
3/0	22 x 64	18"	-	-	26-7/16"	47-3/4"

All dimensions shown are to the center of the muntin.

6/8 Lip Lite Grille Locations

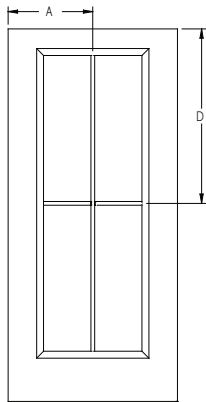

GBG - Lip Lite - 6'8" Full Lite - 2W2H

Panel	Glass	A	B	C	D
2/4	16 x 64	14"	-	-	37-3/16"
2/6	20 x 64	15"	-	-	37-1/8"
2/8	22 x 64	16"	-	-	37-1/8"
2/10	22 x 64	17"	-	-	37-1/8"
3/0	22 x 64	18"	-	-	37-1/8"

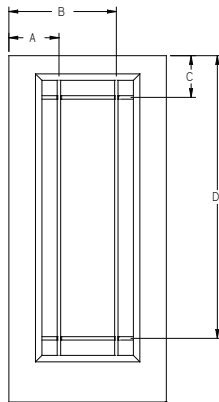

GBG - Lip Lite - 6'8" Full Lite - 9 Lite Prairie

Panel	Glass	A	B	C	D
2/4	16 x 64	10-7/16"	17-9/16"	9-9/16"	64-5/8"
2/6	20 x 64	9-7/16"	20-9/16"	9-9/16"	64-5/8"
2/8	22 x 64	9-7/16"	22-9/16"	9-9/16"	64-5/8"
2/10	22 x 64	10-7/16"	23-9/16"	9-9/16"	64-5/8"
3/0	22 x 64	11-7/16"	24-9/16"	9-9/16"	64-5/8"

All dimensions shown are to the center of the muntin.

6/8 Lip Lite Grille Locations

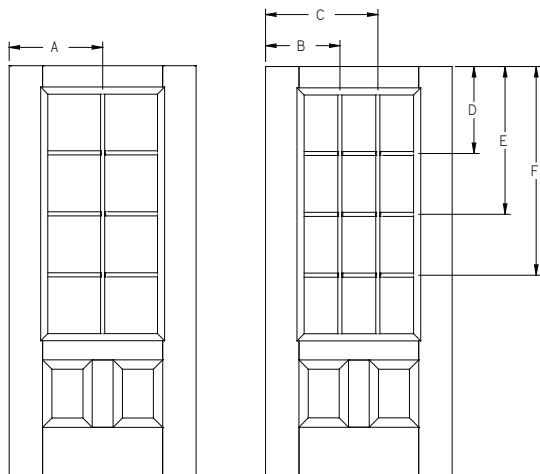

GBG - Lip Lite - 6'8" 3/4 Lite - 3W4H and 2W4H*

Panel	Glass	A	B	C	D	E	F
2/8	22 x 47	16"	12-5/16"	19-11/16"	16-7/8"	28-5/8"	40-3/8"
2/10	22 x 47	17"	13-5/16"	20-11/16"	16-7/8"	28-5/8"	40-3/8"
3/0	22 x 47	18"	14-5/16"	21-11/16"	16-7/8"	28-5/8"	40-3/8"

*SDL not available in 2W4H configuration.

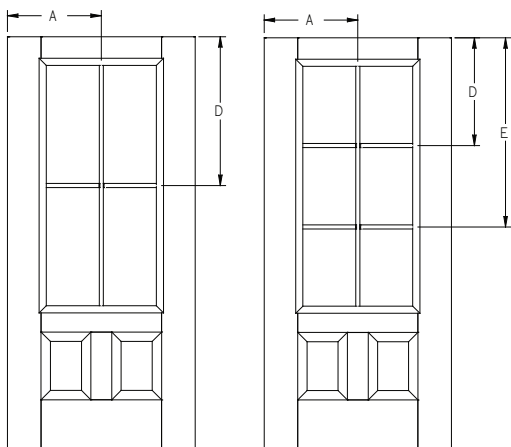

GBG - Lip Lite - 6'8" 3/4 Lite - 2W3H

Panel	Glass	A	B	C	D	E
2/8	22 x 47	16"	-	-	20-3/4"	36-7/16"
2/10	22 x 47	17"	-	-	20-3/4"	36-7/16"
3/0	22 x 47	18"	-	-	20-3/4"	36-7/16"

GBG - Lip Lite - 6'8" 3/4 Lite - 2W2H

Panel	Glass	A	B	C	D
2/8	22 x 47	16"	-	-	28-5/8"
2/10	22 x 47	17"	-	-	28-5/8"
3/0	22 x 47	18"	-	-	28-5/8"

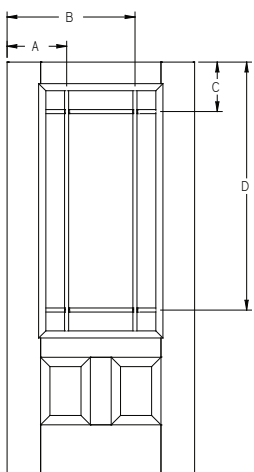

GBG - Lip Lite - 6'8" 3/4 Lite - 9 Lite Prairie

Panel	Glass	A	B	C	D
2/8	22 x 47	9-7/16"	22-9/16"	9-9/16"	47-5/8"
2/10	22 x 47	10-7/16"	23-9/16"	9-9/16"	47-5/8"
3/0	22 x 47	11-7/16"	24-9/16"	9-9/16"	47-5/8"

All dimensions shown are to the center of the muntin.

6/8 Lip Lite Grille Locations

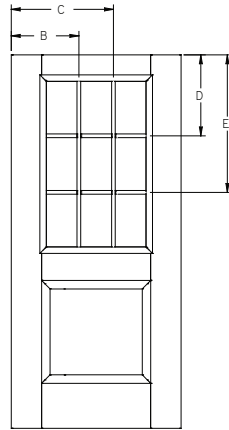

GBG/SDL - Lip Lite - 6'8" Half Lite - 3W3H

Panel	Glass	A	B	C	D	E
*2/6	20 x 36	-	11-11/16"	18-5/16"	17-1/8"	29-1/8"
2/8	22 x 36	-	12-5/16"	19-11/16"	17-1/8"	29-1/8"
2/10	22 x 36	-	13-5/16"	20-11/16"	17-1/8"	29-1/8"
3/0	22 x 36	-	14-5/16"	21-11/16"	17-1/8"	29-1/8"

*SDL not available.

Wood Grilles - Lip Lite - 6'8" Half Lite - 3W3H

Panel	Glass	A	B	C	D	E
2/8	22 x 36	-	12-1/2"	19-1/2"	17-1/4"	28-15/16"
2/10	22 x 36	-	13-1/2"	20-1/2"	17-1/4"	28-15/16"
3/0	22 x 36	-	14-1/2"	21-1/2"	17-1/4"	28-15/16"

Fixed Grilles - Lip Lite - 6'8" Half Lite - 3W3H

Panel	Glass	A	B	C	D	E
2/6	20 x 36	-	11-5/8"	18-5/16"	17-3/16"	29-1/8"
2/8	22 x 36	-	12-13/16"	19-5/8"	17-1/8"	29-1/16"
2/10	22 x 36	-	13-13/16"	20-5/8"	17-1/8"	29-1/16"
3/0	22 x 36	-	14-13/16"	21-5/8"	17-1/8"	29-1/16"

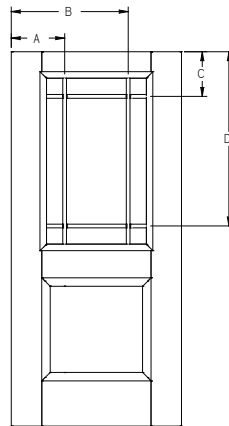

GBG - Lip Lite - 6'8" Half Lite - 9 Lite Prairie

Panel	Glass	A	B	C	D
2/6	20 x 36	9-7/16"	20-9/16"	9-9/16"	36-11/16"
2/8	22 x 36	9-7/16"	22-9/16"	9-9/16"	36-5/8"
2/10	22 x 36	10-7/16"	23-9/16"	9-9/16"	36-5/8"
3/0	22 x 36	11-7/16"	24-9/16"	9-9/16"	36-5/8"

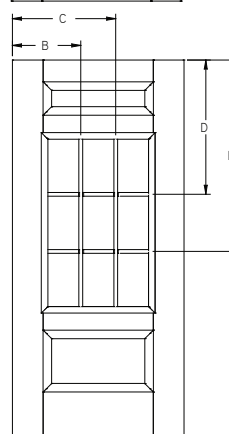

GBG - Lip Lite - 6'8" Half Lite Top and Bottom - 3W3H

Panel	Glass	A	B	C	D	E
2/8	22 x 36	-	12-5/16"	19-11/16"	28-1/8"	40-1/8"
2/10	22 x 36	-	13-5/16"	20-11/16"	28-1/8"	40-1/8"
3/0	22 x 36	-	14-5/16"	21-11/16"	28-1/8"	40-1/8"

Wood Grilles - Lip Lite - 6'8" Half Lite Top and Bottom - 3W3H

Panel	Glass	A	B	C	D	E
2/8	22 x 36	-	12-1/2"	19-1/2"	28-1/4"	39-15/16"
2/10	22 x 36	-	13-1/2"	20-1/2"	28-1/4"	39-15/16"
3/0	22 x 36	-	14-1/2"	21-1/2"	28-1/4"	39-15/16"

Fixed Grilles - Lip Lite - 6'8" Half Lite Top and Bottom - 3W3H

Panel	Glass	A	B	C	D	E
2/8	22 x 36	-	12-13/16"	19-5/8"	28-1/8"	40-1/16"
2/10	22 x 36	-	13-13/16"	20-5/8"	28-1/8"	40-1/16"
3/0	22 x 36	-	14-13/16"	21-5/8"	28-1/8"	40-1/16"

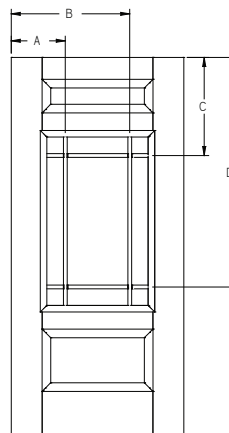

GBG - Lip Lite - 6'8" Half Lite Top and Bottom - 9 Lite Prairie

Panel	Glass	A	B	C	D
2/8	22 x 36	9-7/16"	22-9/16"	20-9/16"	47-11/16"
2/10	22 x 36	10-7/16"	23-9/16"	20-9/16"	47-11/16"
3/0	22 x 36	11-7/16"	24-9/16"	20-9/16"	47-11/16"

All dimensions shown are to the center of the muntin.

6/8 Lip Lite Grille Locations

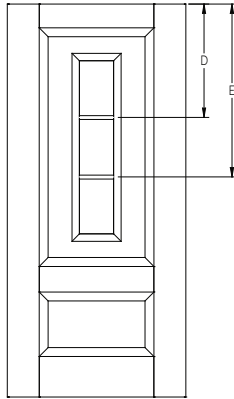

GBG/SDL - Lip Lite - 6'8" Center Lite - 1W3H

Panel	Glass	A	B	C	D	E
2/8	8 x 36	-	-	-	22-7/8"	34-7/8"
2/10	8 x 36	-	-	-	22-7/8"	34-7/8"
3/0	8 x 36	-	-	-	22-7/8"	34-7/8"

Wood Grilles - Lip Lite - 6'8" Center Lite - 1W3H

Panel	Glass	A	B	C	D	E
2/8	8 x 36	-	-	-	23-1/16"	34-11/16"
2/10	8 x 36	-	-	-	23-1/16"	34-11/16"
3/0	8 x 36	-	-	-	23-1/16"	34-11/16"

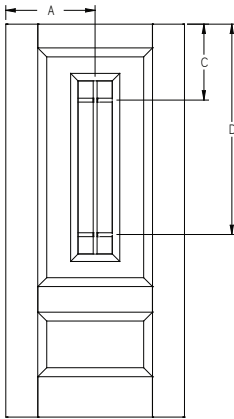

GBG - Lip Lite - 6'8" Center Lite - 6 Lite Prairie

Panel	Glass	A	B	C	D
2/8	8 x 36	16"	-	15-5/16"	42-7/16"
2/10	8 x 36	17"	-	15-5/16"	42-7/16"
3/0	8 x 36	18"	-	15-5/16"	42-7/16"

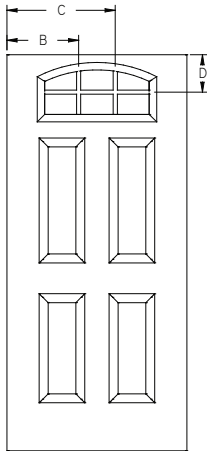

GBG - Lip Lite - 6'8" Camber Top Lite - 3W2H

Panel	Glass	A	B	C	D
2/6	22 x 10	-	11-5/16"	17-5/16"	7-1/2"
2/8	22 x 10	-	12-5/16"	19-11/16"	7-1/2"
2/10	22 x 10	-	13-5/16"	20-11/16"	7-1/2"
3/0	22 x 10	-	14-5/16"	21-11/16"	7-1/2"

Fixed Grilles - Lip Lite - 6'8" Camber Top Lite - 3W2H

Panel	Glass	A	B	C	D
2/6	22 x 10	-	11-7/8"	18-11/16"	7-1/2"
2/8	22 x 10	-	12-7/8"	19-11/16"	7-1/2"
2/10	22 x 10	-	13-7/8"	20-11/16"	7-1/2"
3/0	22 x 10	-	14-7/8"	21-11/16"	7-1/2"

All dimensions shown are to the center of the muntin.

6/8 Lip Lite Grille Locations

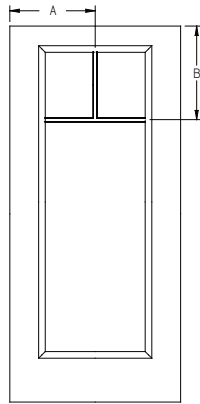

GBG/SDL - Lip Lite - 6'8" Full Lite Craftsman - 2W1H

Panel	Glass	A	B
2/4	16 x 64	14"	19-15/16"
2/6	20 x 64	15"	19-15/16"
2/8	22 x 64	16"	19-15/16"
2/10	22 x 64	17"	19-15/16"
3/0	22 x 64	18"	19-15/16"

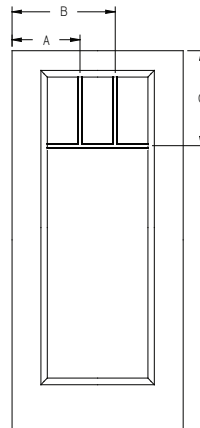

GBG/SDL - Lip Lite - 6'8" Full Lite Craftsman - 3W1H

Panel	Glass	A	B	C
2/4	16 x 64	11-5/16"	16-11/16"	19-15/16"
2/6	20 x 64	11-5/8"	18-3/8"	19-15/16"
2/8	22 x 64	12-1/4"	19-3/4"	19-15/16"
2/10	22 x 64	13-1/4"	20-3/4"	19-15/16"
3/0	22 x 64	14-1/4"	21-3/4"	19-15/16"

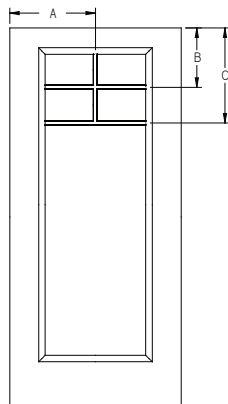

GBG/SDL - Lip Lite - 6'8" Full Lite Craftsman - 2W2H

Panel	Glass	A	B	C
2/4	16 x 64	14"	12-7/16"	19-15/16"
2/6	20 x 64	15"	12-7/16"	19-15/16"
2/8	22 x 64	16"	12-7/16"	19-15/16"
2/10	22 x 64	17"	12-7/16"	19-15/16"
3/0	22 x 64	18"	12-7/16"	19-15/16"

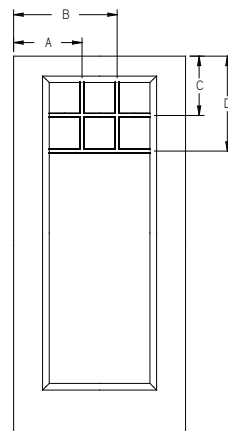

GBG - Lip Lite - 6'8" Full Lite Craftsman - 3W2H

Panel	Glass	A	B	C	D
2/4	16 x 64	11-5/16"	16-11/16"	12-7/16"	19-15/16"
2/6	20 x 64	11-5/8"	18-3/8"	12-7/16"	19-15/16"
2/8	22 x 64	12-1/4"	19-3/4"	12-7/16"	19-15/16"
2/10	22 x 64	13-1/4"	20-3/4"	12-7/16"	19-15/16"
3/0	22 x 64	14-1/4"	21-3/4"	12-7/16"	19-15/16"

All dimensions shown are to the center of the muntin.

6/8 Lip Lite Grille Locations

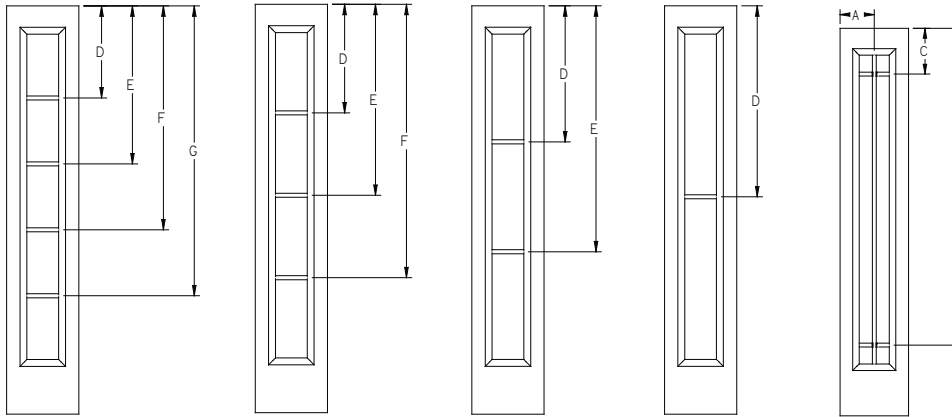

GBG/SDL - Lip Lite - 6'8" Full Lite Sidelite - 1W5H

Panel	Glass	A	B	C	D	E	F	G
12"	7 x 64	-	-	-	17-15/16"	30-3/4"	43-1/2"	56-5/16"
14"	7 x 64	-	-	-	17-15/16"	30-3/4"	43-1/2"	56-5/16"

Wood Grilles - Lip Lite - 6'8" Full Lite Sidelite - 1W5H

Panel	Glass	A	B	C	D	E	F	G
12"	7 x 64	-	-	-	18-1/4"	30-13/16"	43-7/16"	56"
14"	7 x 64	-	-	-	18-1/4"	30-13/16"	43-7/16"	56"

Fixed Grilles - Lip Lite - 6'8" Full Lite Sidelite - 1W5H

Panel	Glass	A	B	C	D	E	F	G
12"	7 x 64	-	-	-	18"	30-3/4"	43-1/2"	56-1/4"
14"	7 x 64	-	-	-	18"	30-3/4"	43-1/2"	56-1/4"

GBG - Lip Lite - 6'8" Full Lite Sidelite - 1W4H

Panel	Glass	A	B	C	D	E	F
12"	7 x 64	-	-	-	21-1/8"	37-1/8"	53-1/8"
14"	7 x 64	-	-	-	21-1/8"	37-1/8"	53-1/8"

GBG - Lip Lite - 6'8" Full Lite Sidelite - 1W3H

Panel	Glass	A	B	C	D	E
12"	7 x 64	-	-	-	26-7/16"	47-13/16"
14"	7 x 64	-	-	-	26-7/16"	47-13/16"

GBG - Lip Lite - 6'8" Full Lite Sidelite - 1W2H

Panel	Glass	A	B	C	D
12"	7 x 64	-	-	-	37-1/8"
14"	7 x 64	-	-	-	37-1/8"

GBG - Lip Lite - 6'8" Full Lite Sidelite - 6 Lite Prairie

Panel	Glass	A	B	C	D
12"	7 x 64	6"	-	9-9/16"	64-11/16"
14"	7 x 64	7"	-	9-9/16"	64-11/16"

All dimensions shown are to the center of the muntin.

6/8 Lip Lite Grille Locations

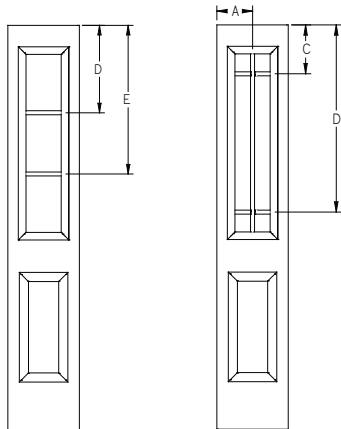

GBG/SDL - Lip Lite - 6'8" Half Lite Sidelite - 1W3H

Panel	Glass	A	B	C	D	E
12"	8 x 36	-	-	-	17-1/8"	29-1/8"
14"	8 x 36	-	-	-	17-1/8"	29-1/8"

Wood Grilles - Lip Lite - 6'8" Half Lite Sidelite - 1W3H

Panel	Glass	A	B	C	D	E
12"	8 x 36	-	-	-	17-1/4"	28-15/16"
14"	8 x 36	-	-	-	17-1/4"	28-15/16"

Fixed Grilles - Lip Lite - 6'8" Half Lite Sidelite - 1W3H

Panel	Glass	A	B	C	D	E
12"	8 x 36	-	-	-	17-1/8"	29-1/16"
14"	8 x 36	-	-	-	17-1/8"	29-1/16"

GBG - Lip Lite - 6'8" Half Lite Sidelite - 6 Lite Prairie

Panel	Glass	A	B	C	D
12"	8 x 36	6"	-	9-9/16"	36-11/16"
14"	8 x 36	7"	-	9-9/16"	36-11/16"

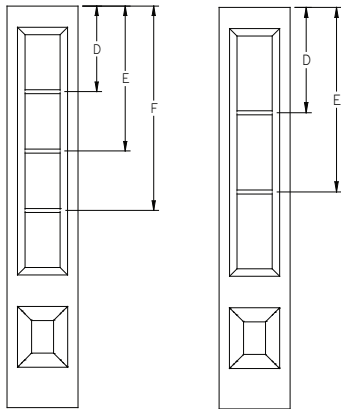

GBG/SDL - Lip Lite - 6'8" 3/4 Lite Sidelite - 1W4H

Panel	Glass	A	B	C	D	E	F
12"	8 x 47	-	-	-	16-13/16"	28-9/16"	40-1/4"
14"	8 x 47	-	-	-	16-13/16"	28-9/16"	40-1/4"

GBG - Lip Lite - 6'8" 3/4 Lite Sidelite - 1W3H

Panel	Glass	A	B	C	D	E
12"	8 x 47	-	-	-	20-3/4"	36-3/8"
14"	8 x 47	-	-	-	20-3/4"	36-3/8"

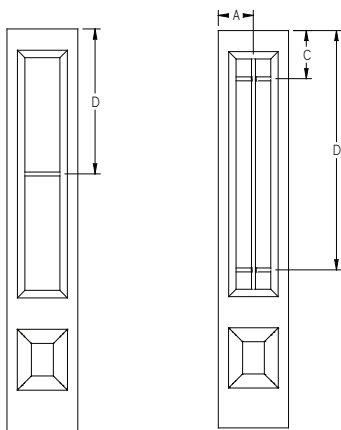

GBG - Lip Lite - 6'8" 3/4 Lite Sidelite - 1W2H

Panel	Glass	A	B	C	D
12"	8 x 47	-	-	-	28-9/16"
14"	8 x 47	-	-	-	28-9/16"

GBG - Lip Lite - 6'8" 3/4 Lite Sidelite - 6 Lite Prairie

Panel	Glass	A	B	C	D
12"	8 x 47	6"	-	9-9/16"	47-11/16"
14"	8 x 47	7"	-	9-9/16"	47-11/16"

All dimensions shown are to the center of the muntin.

8/0 Lip Lite Grille Locations

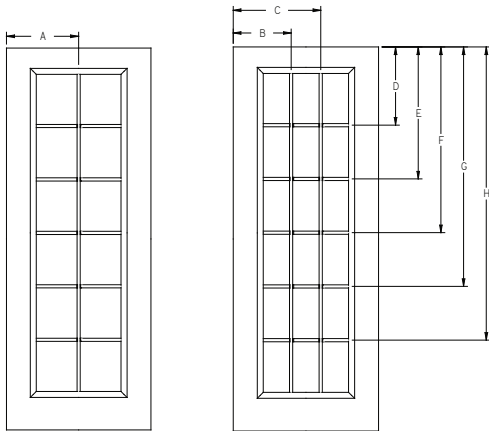

GBG - Lip Lite - 8'0" Full Lite - 3W6H and 2W6H

Panel	Glass	A	B	C	D	E	F	G	H
2/6	20 x 80	15"	11-11/16"	18-5/16"	19-1/2"	32-13/16"	46-3/16"	59-1/2"	72-13/16"
2/8	22 x 80	16"	12-5/16"	19-11/16"	19-1/2"	32-13/16"	46-3/16"	59-1/2"	72-13/16"
2/10	22 x 80	17"	13-5/16"	20-11/16"	19-1/2"	32-13/16"	46-3/16"	59-1/2"	72-13/16"
3/0	22 x 80	18"	14-5/16"	21-11/16"	19-1/2"	32-13/16"	46-3/16"	59-1/2"	72-13/16"

Fixed Grilles - Lip Lite - 8'0" Full Lite - 3W6H and 2W6H

Panel	Glass	A	B	C	D	E	F	G	H
2/6	20 x 80	15"	11-11/16"	18-5/16"	19-9/16"	32-7/8"	46-3/16"	59-7/16"	72-3/4"
2/8	22 x 80	16"	12-3/8"	19-5/8"	19-9/16"	32-7/8"	46-3/16"	59-7/16"	72-3/4"
2/10	22 x 80	17"	13-3/8"	20-5/8"	19-9/16"	32-7/8"	46-3/16"	59-7/16"	72-3/4"
3/0	22 x 80	18"	14-3/8"	21-5/8"	19-9/16"	32-7/8"	46-3/16"	59-7/16"	72-3/4"

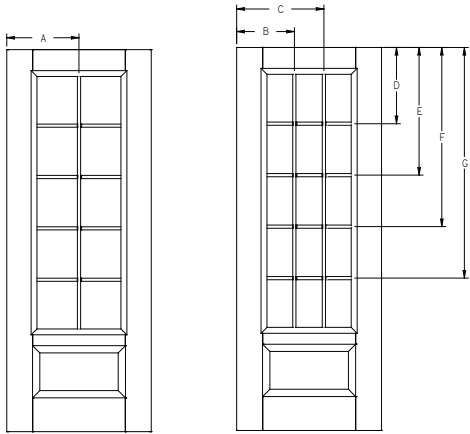

GBG/SDL - Lip Lite - 8'0" 3/4 Lite - 3W5H and 2W5H

Panel	Glass	A	B	C	D	E	F	G
2/8	22 x 64	16"	12-5/16"	19-11/16"	18-15/16"	31-3/4"	44-9/16"	57-3/8"
2/10	22 x 64	17"	13-5/16"	20-11/16"	18-15/16"	31-3/4"	44-9/16"	57-3/8"
3/0	22 x 64	18"	14-5/16"	21-11/16"	18-15/16"	31-3/4"	44-9/16"	57-3/8"

Wood Grilles - Lip Lite - 8'0" 3/4 Lite - 3W5H and 2W5H

Panel	Glass	A	B	C	D	E	F	G
2/8	22 x 64	16"	12-1/2"	19-1/2"	19-1/4"	31-7/8"	44-7/16"	57-1/16"
2/10	22 x 64	17"	13-1/2"	20-1/2"	19-1/4"	31-7/8"	44-7/16"	57-1/16"
3/0	22 x 64	18"	14-1/2"	21-1/2"	19-1/4"	31-7/8"	44-7/16"	57-1/16"

Fixed Grilles - Lip Lite - 8'0" 3/4 Lite - 3W5H and 2W5H

Panel	Glass	A	B	C	D	E	F	G
2/8	22 x 64	16"	12-3/8"	19-5/8"	19-1/16"	31-13/16"	44-9/16"	57-5/16"
2/10	22 x 64	17"	13-3/8"	20-5/8"	19-1/16"	31-13/16"	44-9/16"	57-5/16"
3/0	22 x 64	18"	14-3/8"	21-5/8"	19-1/16"	31-13/16"	44-9/16"	57-5/16"

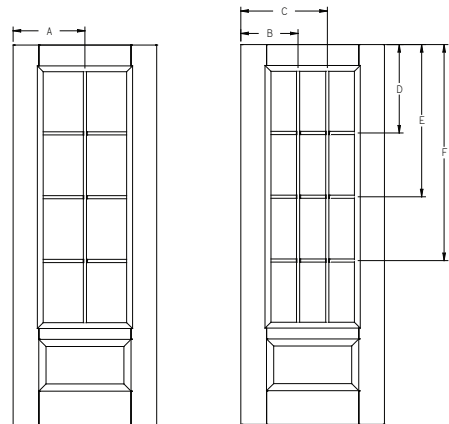

GBG - Lip Lite - 8'0" 3/4 Lite - 3W4H and 2W4H

Panel	Glass	A	B	C	D	E	F
2/8	22 x 64	16"	12-5/16"	19-11/16"	22-3/16"	38-3/16"	54-3/16"
2/10	22 x 64	17"	13-5/16"	20-11/16"	22-3/16"	38-3/16"	54-3/16"
3/0	22 x 64	18"	14-5/16"	21-11/16"	22-3/16"	38-3/16"	54-3/16"

All dimensions shown are to the center of the muntin.

8/0 Lip Lite Grille Locations

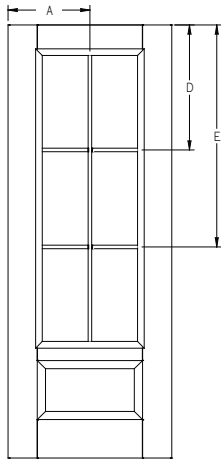

GBG - Lip Lite - 8'0" 3/4 Lite - 2W3H

Panel	Glass	A	B	C	D	E
2/8	22 x 64	16"	-	-	27-1/2"	48-13/16"
2/10	22 x 64	17"	-	-	27-1/2"	48-13/16"
3/0	22 x 64	18"	-	-	27-1/2"	48-13/16"

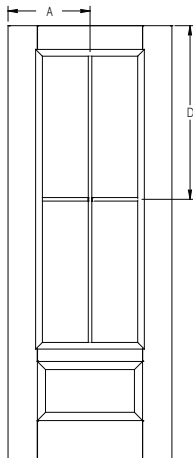

GBG - Lip Lite - 8'0" 3/4 Lite - 2W2H

Panel	Glass	A	B	C	D
2/8	22 x 64	16"	-	-	38-3/16"
2/10	22 x 64	17"	-	-	38-3/16"
3/0	22 x 64	18"	-	-	38-3/16"

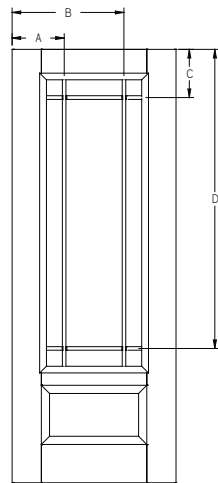

GBG - Lip Lite - 8'0" 3/4 Lite - 9 Lite Prairie

Panel	Glass	A	B	C	D
2/8	22 x 64	9-7/16"	22-9/16"	10-5/8"	65-3/4"
2/10	22 x 64	10-7/16"	23-9/16"	10-5/8"	65-3/4"
3/0	22 x 64	11-7/16"	24-9/16"	10-5/8"	65-3/4"

All dimensions shown are to the center of the muntin.

8/0 Lip Lite Grille Locations

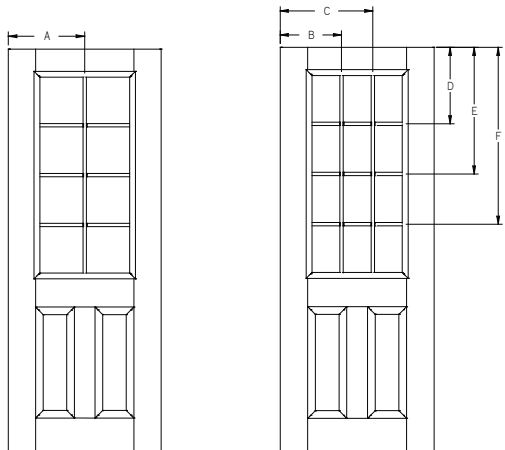

GBG/SDL - Lip Lite - 8'0" Half Lite - 3W4H and 2W4H*

Panel	Glass	A	B	C	D	E	F
2/8	22 x 47	16"	12-5/16"	19-11/16"	17-15/16"	29-11/16"	41-7/16"
2/10	22 x 47	17"	13-5/16"	20-11/16"	17-15/16"	29-11/16"	41-7/16"
3/0	22 x 47	18"	14-5/16"	21-11/16"	17-15/16"	29-11/16"	41-7/16"

*SDL not available in 2W4H configuration.

Wood Grilles - Lip Lite - 8'0" Half Lite - 3W4H

Panel	Glass	A	B	C	D	E	F
2/8	22 x 47	-	12-7/16"	19-9/16"	18-1/8"	29-11/16"	41-3/16"
2/10	22 x 47	-	13-7/16"	20-9/16"	18-1/8"	29-11/16"	41-3/16"
3/0	22 x 47	-	14-7/16"	21-9/16"	18-1/8"	29-11/16"	41-3/16"

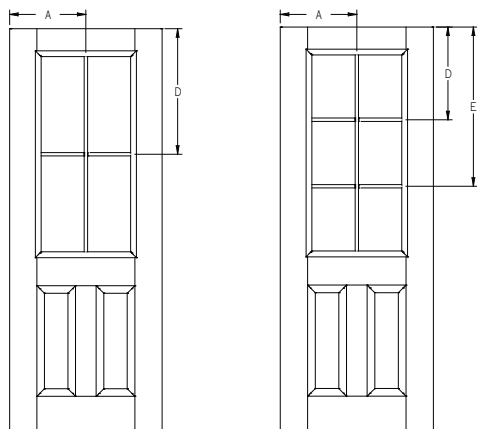

GBG - Lip Lite - 8'0" Half Lite - 2W3H

Panel	Glass	A	B	C	D	E
2/8	22 x 47	16"	-	-	21-13/16"	37-1/2"
2/10	22 x 47	17"	-	-	21-13/16"	37-1/2"
3/0	22 x 47	18"	-	-	21-13/16"	37-1/2"

GBG - Lip Lite - 8'0" Half Lite - 2W2H

Panel	Glass	A	B	C	D
2/8	22 x 47	16"	-	-	29-11/16"
2/10	22 x 47	17"	-	-	29-11/16"
3/0	22 x 47	18"	-	-	29-11/16"

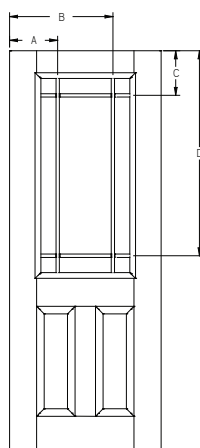

GBG - Lip Lite - 8'0" Half Lite - 9 Lite Prairie

Panel	Glass	A	B	C	D
2/8	22 x 47	9-7/16"	22-9/16"	10-5/8"	48-3/4"
2/10	22 x 47	10-7/16"	23-9/16"	10-5/8"	48-3/4"
3/0	22 x 47	11-7/16"	24-9/16"	10-5/8"	48-3/4"

All dimensions shown are to the center of the muntin.

8/0 Lip Lite Grille Locations

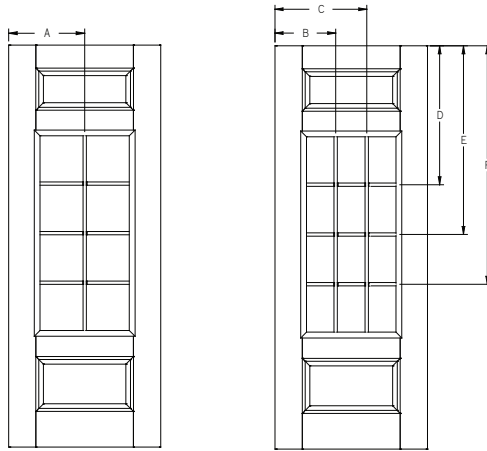

GBG/SDL - Lip Lite - 8'0" Half Lite Top and Bottom - 3W4H and 2W4H*

Panel	Glass	A	B	C	D	E	F
2/6	20 x 47	15"	12-5/16"	19-11/16"	32-7/8"	44-5/8"	56-3/8"
2/8	22 x 47	16"	12-5/16"	19-11/16"	32-7/8"	44-5/8"	56-3/8"
2/10	22 x 47	17"	13-5/16"	20-11/16"	32-7/8"	44-5/8"	56-3/8"
3/0	22 x 47	18"	14-5/16"	21-11/16"	32-7/8"	44-5/8"	56-3/8"

*SDL not available in 2W4H configuration.

Wood Grilles - Lip Lite - 8'0" Half Lite Top and Bottom - 3W4H

Panel	Glass	A	B	C	D	E	F
2/8	22 x 47	-	12-7/16"	19-9/16"	33-1/16"	44-5/8"	56-3/16"
2/10	22 x 47	-	13-7/16"	20-9/16"	33-1/16"	44-5/8"	56-3/16"
3/0	22 x 47	-	14-7/16"	21-9/16"	33-1/16"	44-5/8"	56-3/16"

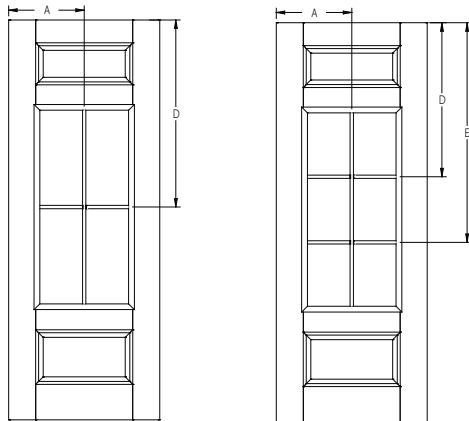

GBG - Lip Lite - 8'0" Half Lite Top and Bottom - 2W3H

Panel	Glass	A	B	C	D	E
2/8	22 x 47	16"	-	-	36-13/16"	52-7/16"
2/10	22 x 47	17"	-	-	36-13/16"	52-7/16"
3/0	22 x 47	18"	-	-	36-13/16"	52-7/16"

GBG - Lip Lite - 8'0" Half Lite Top and Bottom - 2W2H

Panel	Glass	A	B	C	D
2/8	22 x 47	16"	-	-	44-5/8"
2/10	22 x 47	17"	-	-	44-5/8"
3/0	22 x 47	18"	-	-	44-5/8"

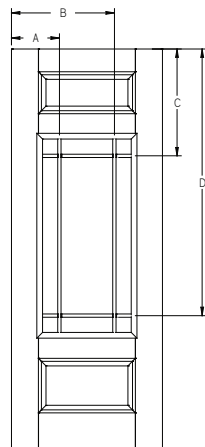

GBG - Lip Lite - 8'0" Half Lite Top and Bottom - 9 Lite Prairie

Panel	Glass	A	B	C	D
2/8	22 x 47	9-7/16"	22-9/16"	25-9/16"	63-11/16"
2/10	22 x 47	10-7/16"	23-9/16"	25-9/16"	63-11/16"
3/0	22 x 47	11-7/16"	24-9/16"	25-9/16"	63-11/16"

All dimensions shown are to the center of the muntin.

8/0 Lip Lite Grille Locations

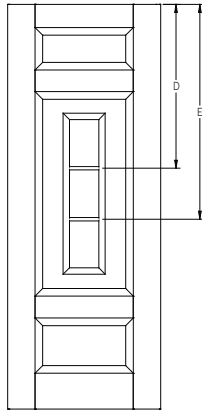

GBG - Lip Lite - 8'0" Center Lite - 1W3H

Panel	Glass	A	B	C	D	E
2/8	8 x 36	-	-	-	38-9/16"	50-9/16"
2/10	8 x 36	-	-	-	38-9/16"	50-9/16"
3/0	8 x 36	-	-	-	38-9/16"	50-9/16"

Wood Grilles - Lip Lite - 8'0" Center Lite - 1W3H

Panel	Glass	A	B	C	D	E
2/8	8 x 36	-	-	-	38-3/4"	50-7/16"
2/10	8 x 36	-	-	-	38-3/4"	50-7/16"
3/0	8 x 36	-	-	-	38-3/4"	50-7/16"

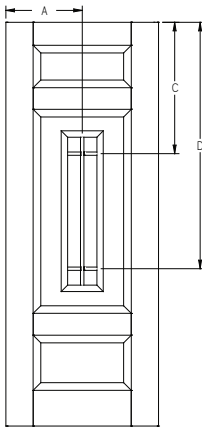

GBG - Lip Lite - 8'0" Center Lite - 6 Lite Prairie

Panel	Glass	A	B	C	D
2/8	8 x 36	16"	-	31"	58-1/8"
2/10	8 x 36	17"	-	31"	58-1/8"
3/0	8 x 36	18"	-	31"	58-1/8"

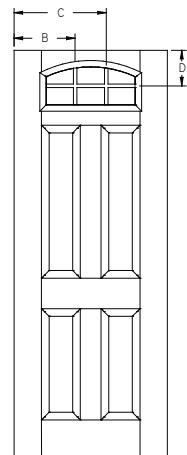

GBG - Lip Lite - 8'0" Camber Top Lite - 3W2H

Panel	Glass	A	B	C	D
2/6	22 x 10	-	11-5/16"	17-5/16"	8-3/8"
2/8	22 x 10	-	12-5/16"	19-11/16"	8-3/8"
2/10	22 x 10	-	13-5/16"	20-11/16"	8-3/8"
3/0	22 x 10	-	14-5/16"	21-11/16"	8-3/8"

Fixed Grilles - Lip Lite - 8'0" Camber Top Lite - 3W2H

Panel	Glass	A	B	C	D
2/6	22 x 10	-	11-7/8"	18-11/16"	8-3/8"
2/8	22 x 10	-	12-7/8"	19-11/16"	8-3/8"
2/10	22 x 10	-	13-7/8"	20-11/16"	8-3/8"
3/0	22 x 10	-	14-7/8"	21-11/16"	8-3/8"

All dimensions shown are to the center of the muntin.

8/0 Lip Lite Grille Locations

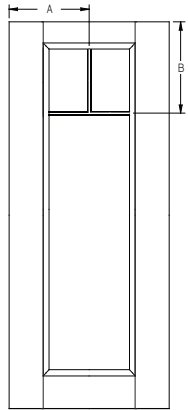

GBG/SDL - Lip Lite - 8'0" Full Lite Craftsman - 2W1H

Panel	Glass	A	B
2/0	14 x 80	12"	21-1/16"
2/6	20 x 80	15"	21"
2/8	22 x 80	16"	21"
2/10	22 x 80	17"	21"
3/0	22 x 80	18"	21"

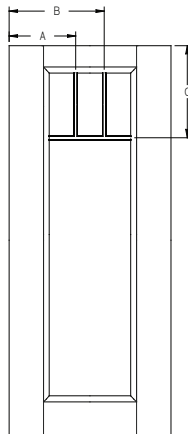

GBG/SDL - Lip Lite - 8'0" Full Lite Craftsman - 3W1H

Panel	Glass	A	B	C
2/0	14 x 80	9-5/8"	14-3/8"	21-1/16"
2/6	20 x 80	11-5/8"	18-3/8"	21"
2/8	22 x 80	12-1/4"	19-3/4"	21"
2/10	22 x 80	13-1/4"	20-3/4"	21"
3/0	22 x 80	14-1/4"	21-3/4"	21"

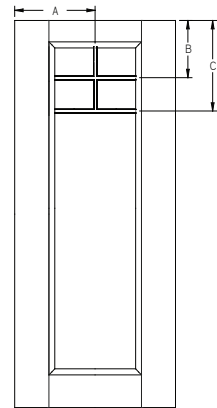

GBG/SDL - Lip Lite - 8'0" Full Lite Craftsman - 2W2H

Panel	Glass	A	B	C
2/0	14 x 80	12"	13-9/16"	21-1/16"
2/6	20 x 80	15"	13-1/2"	21"
2/8	22 x 80	16"	13-1/2"	21"
2/10	22 x 80	17"	13-1/2"	21"
3/0	22 x 80	18"	13-1/2"	21"

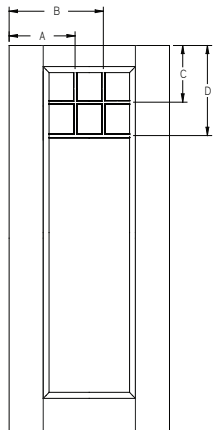

GBG/SDL - Lip Lite - 8'0" Full Lite Craftsman - 3W2H

Panel	Glass	A	B	C	D
2/0	14 x 80	9-5/8"	14-3/8"	13-9/16"	21-1/16"
2/6	20 x 80	11-5/8"	18-3/8"	13-1/2"	21"
2/8	22 x 80	12-1/4"	19-3/4"	13-1/2"	21"
2/10	22 x 80	13-1/4"	20-3/4"	13-1/2"	21"
3/0	22 x 80	14-1/4"	21-3/4"	13-1/2"	21"

All dimensions shown are to the center of the muntin.

8/0 Lip Lite Grille Locations

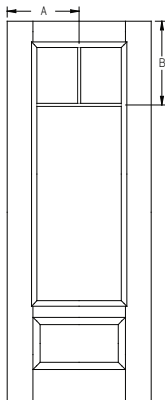

GBG/SDL - Lip Lite - 8'0" 3/4 Lite Craftsman - 2W1H

Panel	Glass	A	B
2/8	22 x 64	16"	21"
2/10	22 x 64	17"	21"
3/0	22 x 64	18"	21"

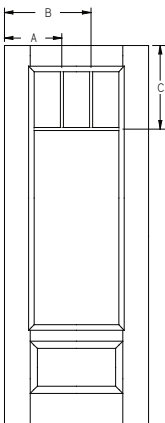

GBG/SDL - Lip Lite - 8'0" 3/4 Lite Craftsman - 3W1H

Panel	Glass	A	B	C
2/8	22 x 64	12-1/4"	19-3/4"	21"
2/10	22 x 64	13-1/4"	20-3/4"	21"
3/0	22 x 64	14-1/4"	21-3/4"	21"

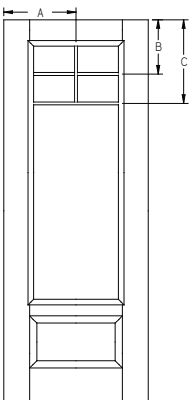

GBG/SDL - Lip Lite - 8'0" 3/4 Lite Craftsman - 2W2H

Panel	Glass	A	B	C
2/8	22 x 64	16"	13-1/2"	21"
2/10	22 x 64	17"	13-1/2"	21"
3/0	22 x 64	18"	13-1/2"	21"

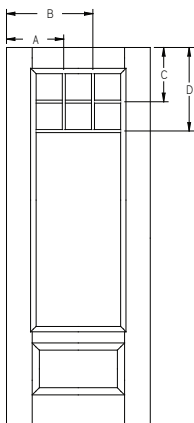

GBG/SDL - Lip Lite - 8'0" 3/4 Lite Craftsman - 3W2H

Panel	Glass	A	B	C	D
2/8	22 x 64	12-1/4"	19-3/4"	13-1/2"	21"
2/10	22 x 64	13-1/4"	20-3/4"	13-1/2"	21"
3/0	22 x 64	14-1/4"	21-3/4"	13-1/2"	21"

All dimensions shown are to the center of the muntin.

8/0 Lip Lite Grille Locations

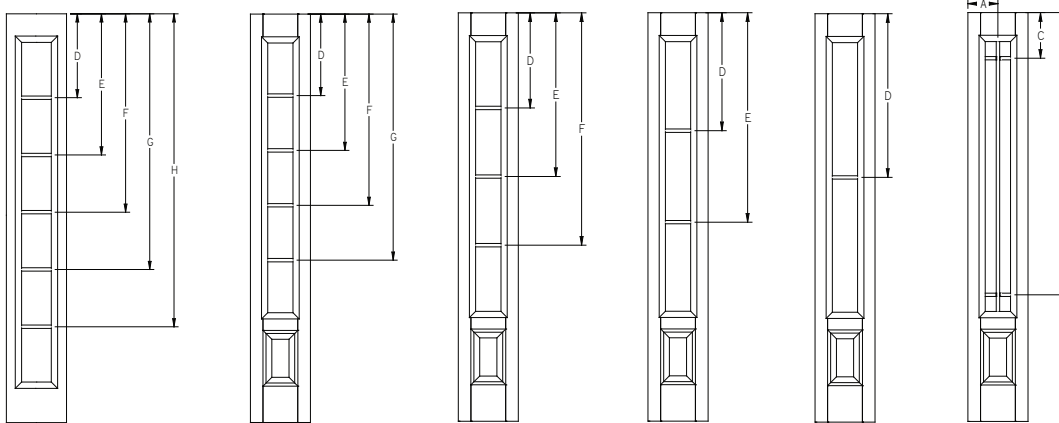

GBG - Lip Lite - 8'0" Full Lite Sidelite - 1W6H

Panel	Glass	A	B	C	D	E	F	G	H
12"	7 x 80	-	-	-	19-5/8"	33"	46-5/16"	59-5/8"	73"
14"	7 x 80	-	-	-	19-5/8"	33"	46-5/16"	59-5/8"	73"

Fixed Grilles - Lip Lite - 8'0" Full Lite Sidelite - 1W6H

Panel	Glass	A	B	C	D	E	F	G	H
12"	7 x 80	-	-	-	19-1/4"	32-13/16"	46-5/16"	59-13/16"	73-3/8"
14"	7 x 80	-	-	-	19-1/4"	32-13/16"	46-5/16"	59-13/16"	73-3/8"

GBG/SDL - Lip Lite - 8'0" 3/4 Lite Sidelite - 1W5H

Panel	Glass	A	B	C	D	E	F	G
12"	7 x 64	-	-	-	19"	31-13/16"	44-9/16"	57-3/8"
14"	7 x 64	-	-	-	19"	31-13/16"	44-9/16"	57-3/8"

Wood Grilles - Lip Lite - 8'0" 3/4 Lite Sidelite - 1W5H

Panel	Glass	A	B	C	D	E	F	G
12"	7 x 64	-	-	-	19-5/16"	31-7/8"	44-1/2"	57-1/16"
14"	7 x 64	-	-	-	19-5/16"	31-7/8"	44-1/2"	57-1/16"

Fixed Grilles - Lip Lite - 8'0" 3/4 Lite Sidelite - 1W5H

Panel	Glass	A	B	C	D	E	F	G
12"	7 x 64	-	-	-	19-1/16"	31-13/16"	44-9/16"	57-5/16"
14"	7 x 64	-	-	-	19-1/16"	31-13/16"	44-9/16"	57-5/16"

GBG - Lip Lite - 8'0" 3/4 Lite Sidelite - 1W4H

Panel	Glass	A	B	C	D	E	F
12"	7 x 64	-	-	-	22-3/16"	38-3/16"	54-3/16"
14"	7 x 64	-	-	-	22-3/16"	38-3/16"	54-3/16"

GBG - Lip Lite - 8'0" 3/4 Lite Sidelite - 1W3H

Panel	Glass	A	B	C	D	E
12"	7 x 64	-	-	-	27-1/2"	48-7/8"
14"	7 x 64	-	-	-	27-1/2"	48-7/8"

GBG - Lip Lite - 8'0" 3/4 Lite Sidelite - 1W2H

Panel	Glass	A	B	C	D
12"	7 x 64	-	-	-	38-3/16"
14"	7 x 64	-	-	-	38-3/16"

GBG - Lip Lite - 8'0" 3/4 Lite Sidelite - 6 Lite Prairie

Panel	Glass	A	B	C	D
12"	7 x 64	6"	-	10-5/8"	65-3/4"
14"	7 x 64	7"	-	10-5/8"	65-3/4"

All dimensions shown are to the center of the muntin.

8/0 Lip Lite Grille Locations

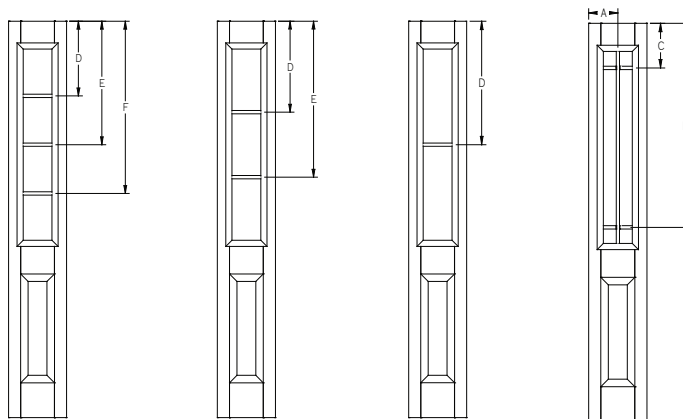

GBG/SDL - Lip Lite - 8'0" Half Lite Sidelite - 1W4H

Panel	Glass	A	B	C	D	E	F
12"	8 x 47	-	-	-	17-7/8"	29-5/8"	41-5/16"
14"	8 x 47	-	-	-	17-7/8"	29-5/8"	41-5/16"

GBG - Lip Lite - 8'0" Half Lite Sidelite - 1W3H

Panel	Glass	A	B	C	D	E
12"	8 x 47	-	-	-	21-13/16"	37-7/16"
14"	8 x 47	-	-	-	21-13/16"	37-7/16"

GBG - Lip Lite - 8'0" Half Lite Sidelite - 1W2H

Panel	Glass	A	B	C	D
12"	8 x 47	-	-	-	29-5/8"
14"	8 x 47	-	-	-	29-5/8"

GBG - Lip Lite - 8'0" Half Lite Sidelite - 6 Lite Prairie

Panel	Glass	A	B	C	D
12"	8 x 47	6"	-	10-5/8"	48-3/4"
14"	8 x 47	7"	-	10-5/8"	48-3/4"

All dimensions shown are to the center of the muntin.

6/8 Flush-Glazed Grille Locations

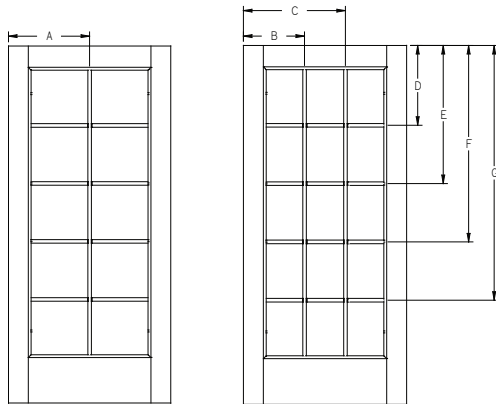

GBG/SDL - Flush-Glazed - Smooth-Star - 6'8" Full Lite - 3W5H and 2W5H

Panel	Glass	A	B	C	D	E	F	G
2/6	20 x 64	15"	11-1/2"	18-1/2"	17-7/16"	30-5/16"	43-3/16"	56"
2/8	20 x 64	16"	12-1/2"	19-1/2"	17-7/16"	30-5/16"	43-3/16"	56"
2/10	25 x 64	17"	12-13/16"	21-3/16"	17-7/16"	30-5/16"	43-3/16"	56"
3/0	25 x 64	18"	13-13/16"	22-3/16"	17-7/16"	30-5/16"	43-3/16"	56"

GBG/SDL - Flush-Glazed - Fiber Classic - 6'8" Full Lite - 3W5H and 2W5H

Panel	Glass	A	B	C	D	E	F	G
2/6	20 x 64	15"	11-1/2"	18-1/2"	17-5/8"	30-1/2"	43-5/16"	56-3/16"
2/8	20 x 64	16"	12-1/2"	19-1/2"	17-5/8"	30-1/2"	43-5/16"	56-3/16"
*2/10	25 x 64	17"	12-13/16"	21-3/16"	17-5/8"	30-1/2"	43-5/16"	56-3/16"
3/0	27 x 64	18"	13-1/2"	22-1/2"	17-5/8"	30-1/2"	43-3/8"	56-1/4"

*Only available in 6/6

Wood Grilles - Flush-Glazed - Smooth-Star - 6'8" Full Lite - 3W5H and 2W5H

Panel	Glass	A	B	C	D	E	F	G
2/6	20 x 64	15"	11-9/16"	18-7/16"	17-11/16"	30-3/8"	43-1/8"	55-13/16"
2/8	20 x 64	16"	12-9/16"	19-7/16"	17-11/16"	30-3/8"	43-1/8"	55-13/16"
2/10	25 x 64	17"	12-7/8"	21-1/8"	17-11/16"	30-3/8"	43-1/8"	55-13/16"
3/0	25 x 64	18"	13-7/8"	22-1/8"	17-11/16"	30-3/8"	43-1/8"	55-13/16"

Wood Grilles - Flush-Glazed - Fiber Classic - 6'8" Full Lite - 3W5H and 2W5H

Panel	Glass	A	B	C	D	E	F	G
2/6	20 x 64	15"	11-9/16"	18-7/16"	17-13/16"	30-9/16"	43-1/4"	56"
2/8	20 x 64	16"	12-9/16"	19-7/16"	17-13/16"	30-9/16"	43-1/4"	56"
2/10	25 x 64	17"	12-7/8"	21-1/8"	17-13/16"	30-9/16"	43-1/4"	56"
3/0	25 x 64	18"	13-7/8"	22-1/8"	17-13/16"	30-9/16"	43-1/4"	56"

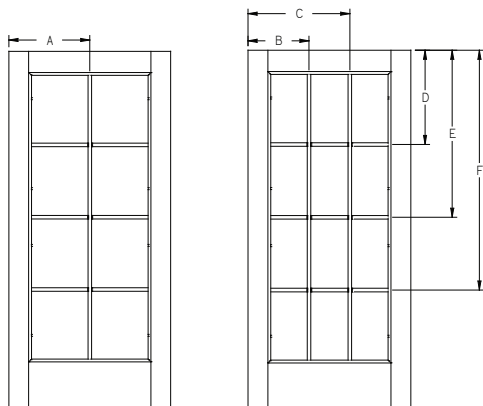

GBG - Flush-Glazed - Smooth-Star - 6'8" Full Lite - 3W4H and 2W4H

Panel	Glass	A	B	C	D	E	F
2/6	20 x 64	15"	11-1/2"	18-1/2"	20-11/16"	36-3/4"	52-13/16"
2/8	20 x 64	16"	12-1/2"	19-1/2"	20-11/16"	36-3/4"	52-13/16"
2/10	25 x 64	17"	13-3/8"	22-7/16"	20-11/16"	36-3/4"	52-7/8"
3/0	25 x 64	18"	14-3/8"	23-7/16"	20-11/16"	36-3/4"	52-7/8"

GBG - Flush-Glazed - Fiber Classic - 6'8" Full Lite - 3W4H and 2W4H

Panel	Glass	A	B	C	D	E	F
2/6	20 x 64	15"	11-1/2"	18-1/2"	20-13/16"	36-15/16"	53"
2/8	20 x 64	16"	12-1/2"	19-1/2"	20-13/16"	36-15/16"	53"
*2/10	25 x 64	17"	13-3/8"	22-7/16"	20-7/8"	36-15/16"	53-1/16"
3/0	27 x 64	18"	13-1/2"	22-1/2"	20-7/8"	36-15/16"	53-1/16"

*Only available in 6/6

All dimensions shown are to the center of the muntin.

6/8 Flush-Glazed Grille Locations

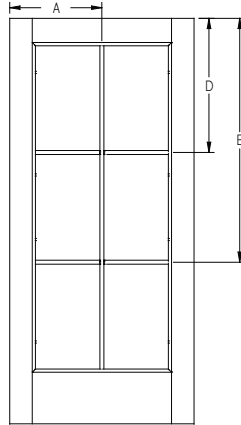

GBG - Flush-Glazed - Smooth-Star - 6'8" Full Lite - 2W3H

Panel	Glass	A	B	C	D	E
2/6	20 x 64	15"	-	-	26"	47-7/16"
2/8	20 x 64	16"	-	-	26"	47-7/16"
2/10	25 x 64	17"	-	-	26"	47-7/16"
3/0	25 x 64	18"	-	-	26"	47-7/16"

GBG - Flush-Glazed - Fiber Classic - 6'8" Full Lite - 2W3H

Panel	Glass	A	B	C	D	E
2/6	20 x 64	15"	-	-	26-3/16"	47-5/8"
2/8	20 x 64	16"	-	-	26-3/16"	47-5/8"
*2/10	25 x 64	17"	-	-	26-3/16"	47-5/8"
3/0	27 x 64	18"	-	-	26-3/16"	47-11/16"

*Only available in 6/6

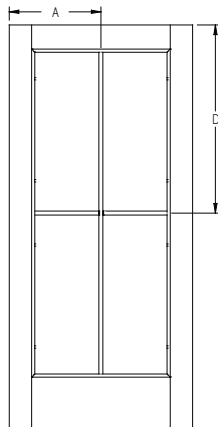

GBG - Flush-Glazed - Smooth-Star - 6'8" Full Lite - 2W2H

Panel	Glass	A	B	C	D
2/6	20 x 64	15"	-	-	36-3/4"
2/8	20 x 64	16"	-	-	36-3/4"
2/10	25 x 64	17"	-	-	36-3/4"
3/0	25 x 64	18"	-	-	36-3/4"

GBG - Flush-Glazed - Fiber Classic - 6'8" Full Lite - 2W2H

Panel	Glass	A	B	C	D
2/6	20 x 64	15"	-	-	36-15/16"
2/8	20 x 64	16"	-	-	36-15/16"
*2/10	25 x 64	17"	-	-	36-15/16"
3/0	27 x 64	18"	-	-	36-15/16"

*Only available in 6/6

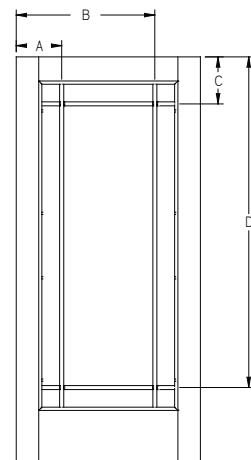

GBG - Flush-Glazed - Smooth-Star - 6'8" Full Lite - 9 Lite Prairie

Panel	Glass	A	B	C	D
2/6	20 x 64	8-7/8"	21-1/8"	9"	64-7/16"
2/8	20 x 64	9-7/8"	22-1/8"	9"	64-7/16"
2/10	25 x 64	8-13/16"	25-3/16"	9"	64-7/16"
3/0	25 x 64	9-13/16"	26-3/16"	9"	64-7/16"

GBG - Flush-Glazed - Fiber Classic - 6'8" Full Lite - 9 Lite Prairie

Panel	Glass	A	B	C	D
2/6	20 x 64	8-7/8"	21-1/8"	9-3/16"	64-5/8"
2/8	20 x 64	9-7/8"	22-1/8"	9-3/16"	64-5/8"
*2/10	25 x 64	8-13/16"	25-3/16"	9-3/16"	64-5/8"
3/0	27 x 64	8-7/8"	27-1/8"	9-3/16"	64-11/16"

*Only available in 6/6

All dimensions shown are to the center of the muntin.

6/8 Flush-Glazed Grille Locations

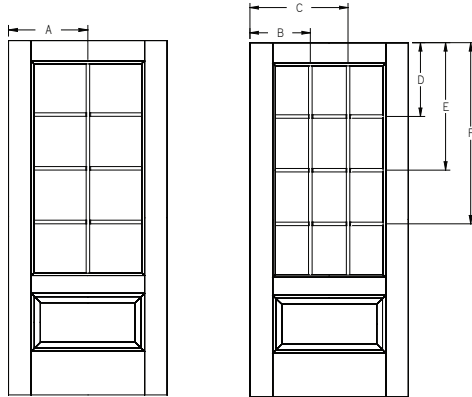

GBG/SDL - Flush-Glazed - Smooth-Star - 6'8" 3/4 Lite - 3W4H and 2W4H*

Panel	Glass	A	B	C	D	E	F
2/6	20 x 64	15"	12-13/16"	21-3/16"	16-5/8"	28-5/8"	40-5/8"
2/8	20 x 64	16"	13-13/16"	22-3/16"	16-5/8"	28-5/8"	40-5/8"
2/10	25 x 47	17"	12-13/16"	21-3/16"	16-9/16"	28-5/8"	40-5/8"
3/0	25 x 47	18"	13-13/16"	22-3/16"	16-9/16"	28-5/8"	40-5/8"

*SDL not available in 2W4H configuration.

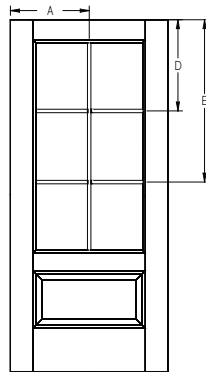

GBG - Flush-Glazed - Smooth-Star - 6'8" 3/4 Lite - 2W3H

Panel	Glass	A	B	C	D	E
2/6	20 x 64	15"	-	-	20-5/8"	36-5/8"
2/8	20 x 64	16"	-	-	20-5/8"	36-5/8"
2/10	25 x 47	17"	-	-	20-5/8"	36-5/8"
3/0	25 x 47	18"	-	-	20-5/8"	36-5/8"

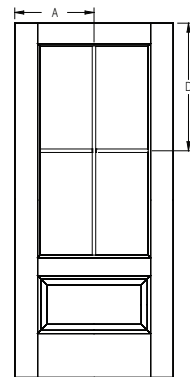

GBG - Flush-Glazed - Smooth-Star - 6'8" 3/4 Lite - 2W2H

Panel	Glass	A	B	C	D
2/6	20 x 64	15"	-	-	28-5/8"
2/8	20 x 64	16"	-	-	28-5/8"
2/10	25 x 47	17"	-	-	28-5/8"
3/0	25 x 47	18"	-	-	28-5/8"

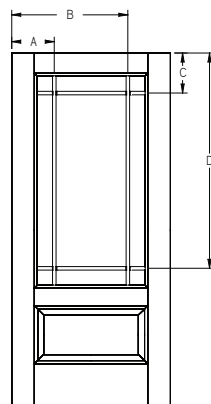

GBG - Flush-Glazed - Smooth-Star - 6'8" 3/4 Lite - 9 Lite Prairie

Panel	Glass	A	B	C	D
2/6	20 x 64	8-13/16"	21-3/16"	9"	48-3/16"
2/8	20 x 64	9-13/16"	22-3/16"	9"	48-3/16"
2/10	25 x 47	8-13/16"	25-3/16"	9"	48-3/16"
3/0	25 x 47	9-13/16"	26-3/16"	9"	48-3/16"

All dimensions shown are to the center of the muntin.

6/8 Flush-Glazed Grille Locations

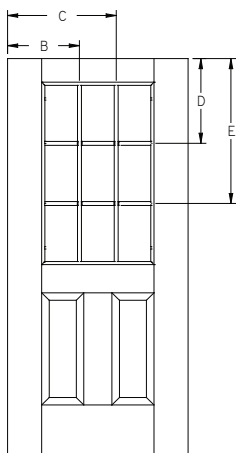

GBG/SDL - Flush-Glazed - Smooth-Star - 6'8" Half Lite - 3W3H

Panel	Glass	A	B	C	D	E
2/6	22 x 36	-	11-5/16"	18-11/16"	16-5/8"	28-3/4"
2/8	22 x 36	-	12-5/16"	19-11/16"	16-5/8"	28-3/4"
3/0	22 x 36	-	14-5/16"	21-11/16"	16-5/8"	28-3/4"

GBG/SDL - Flush-Glazed - Fiber Classic - 6'8" Half Lite - 3W3H

Panel	Glass	A	B	C	D	E
2/6	22 x 36	-	11-5/16"	18-11/16"	16-7/8"	28-15/16"
2/8	22 x 36	-	12-5/16"	19-11/16"	16-7/8"	28-15/16"
3/0	22 x 36	-	14-5/16"	21-11/16"	16-7/8"	28-15/16"

Wood Grilles - Flush-Glazed - Smooth-Star - 6'8" Half Lite - 3W3H

Panel	Glass	A	B	C	D	E
2/6	22 x 36	-	11-7/16"	18-9/16"	16-3/4"	28-9/16"
2/8	22 x 36	-	12-7/16"	19-9/16"	16-3/4"	28-9/16"
3/0	22 x 36	-	14-7/16"	21-9/16"	16-3/4"	28-9/16"

Wood Grilles - Flush-Glazed - Fiber Classic - 6'8" Half Lite - 3W3H

Panel	Glass	A	B	C	D	E
2/6	22 x 36	-	11-3/8"	18-5/8"	17"	28-13/16"
2/8	22 x 36	-	12-3/8"	19-5/8"	17"	28-13/16"
3/0	22 x 36	-	14-3/8"	21-5/8"	17"	28-13/16"

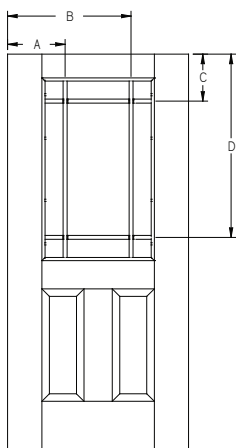

GBG - Flush-Glazed - Smooth-Star - 6'8" Half Lite - 9 Lite Prairie

Panel	Glass	A	B	C	D
2/6	22 x 36	8-5/16"	21-11/16"	8-15/16"	36-3/8"
2/8	22 x 36	9-5/16"	22-11/16"	8-15/16"	36-3/8"
3/0	22 x 36	11-5/16"	24-11/16"	8-15/16"	36-3/8"

GBG - Flush-Glazed - Fiber Classic - 6'8" Half Lite - 9 Lite Prairie

Panel	Glass	A	B	C	D
2/6	22 x 36	8-5/16"	21-11/16"	9-3/16"	36-5/8"
2/8	22 x 36	9-5/16"	22-11/16"	9-3/16"	36-5/8"
3/0	22 x 36	11-5/16"	24-11/16"	9-3/16"	36-5/8"

All dimensions shown are to the center of the muntin.

6/8 Flush-Glazed Grille Locations

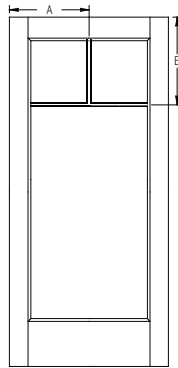

GBG - Flush-Glazed - Smooth-Star - 6'8" Full Lite Craftsman - 2W1H

Panel	Glass	A	B
2/0	14 x 64	12"	20-1/2"
2/6	20 x 64	15"	20-1/8"
2/8	20 x 64	16"	20-1/8"
2/10	25 x 64	17"	20-1/8"
3/0	25 x 64	18"	20-1/8"

GBG - Flush-Glazed - Fiber Classic - 6'8" Full Lite Craftsman - 2W1H

Panel	Glass	A	B
2/0	14 x 64	12"	20-1/8"
2/6	20 x 64	15"	20-5/16"
2/8	20 x 64	16"	20-5/16"
2/10	25 x 64	17"	20-5/16"
3/0	27 x 64	18"	20-5/16"

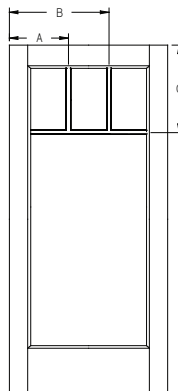

GBG - Flush-Glazed - Smooth-Star - 6'8" Full Lite Craftsman - 3W1H

Panel	Glass	A	B	C
2/0	14 x 64	9-7/16"	14-9/16"	20-3/16"
2/6	20 x 64	11-7/16"	18-9/16"	20-1/8"
2/8	20 x 64	12-7/16"	19-9/16"	20-1/8"
2/10	25 x 64	12-3/4"	21-1/4"	20-1/8"
3/0	25 x 64	13-3/4"	22-1/4"	20-1/8"

GBG - Flush-Glazed - Fiber Classic - 6'8" Full Lite Craftsman - 3W1H

Panel	Glass	A	B	C
2/0	14 x 64	9-7/16"	14-9/16"	20-5/16"
2/6	20 x 64	11-7/16"	18-9/16"	20-5/16"
2/8	20 x 64	12-7/16"	19-9/16"	20-5/16"
2/10	25 x 64	12-3/4"	21-1/4"	20-5/16"
3/0	27 x 64	13-1/2"	22-1/2"	20-5/16"

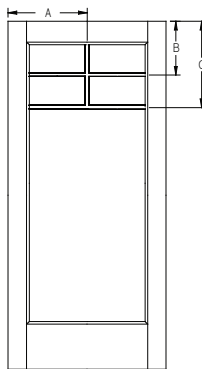

GBG - Flush-Glazed - Smooth-Star - 6'8" Full Lite Craftsman - 2W2H

Panel	Glass	A	B	C
2/0	14 x 64	12"	12-3/8"	20-3/16"
2/6	20 x 64	15"	12-3/8"	20-1/8"
2/8	20 x 64	16"	12-3/8"	20-1/8"
2/10	25 x 64	17"	12-3/8"	20-1/8"
3/0	25 x 64	18"	12-3/8"	20-1/8"

GBG - Flush-Glazed - Fiber Classic - 6'8" Full Lite Craftsman - 2W2H

Panel	Glass	A	B	C
2/0	14 x 64	12"	12-1/2"	20-5/16"
2/6	20 x 64	15"	12-1/2"	20-5/16"
2/8	20 x 64	16"	12-1/2"	20-5/16"
2/10	25 x 64	17"	12-1/2"	20-5/16"
3/0	27 x 64	18"	12-1/2"	20-5/16"

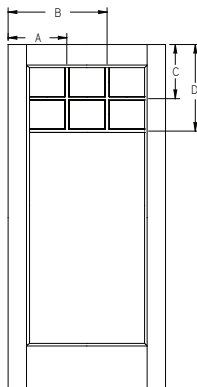

GBG - Flush-Glazed - Smooth-Star - 6'8" Full Lite Craftsman - 3W2H

Panel	Glass	A	B	C	D
2/0	14 x 64	9-7/16"	14-9/16"	12-3/8"	20-3/16"
2/6	20 x 64	11-7/16"	18-9/16"	12-3/8"	20-1/8"
2/8	20 x 64	12-7/16"	19-9/16"	12-3/8"	20-1/8"
2/10	25 x 64	12-3/4"	21-1/4"	12-3/8"	20-1/8"
3/0	25 x 64	13-3/4"	22-1/4"	12-3/8"	20-1/8"

GBG - Flush-Glazed - Fiber Classic - 6'8" Full Lite Craftsman - 3W2H

Panel	Glass	A	B	C	D
2/0	14 x 64	9-7/16"	14-9/16"	12-1/2"	20-5/16"
2/6	20 x 64	11-7/16"	18-9/16"	12-1/2"	20-5/16"
2/8	20 x 64	12-7/16"	19-9/16"	12-1/2"	20-5/16"
2/10	25 x 64	12-3/4"	21-1/4"	12-1/2"	20-5/16"
3/0	27 x 64	13-1/2"	22-1/2"	12-1/2"	20-5/16"

All dimensions shown are to the center of the muntin.

6/8 Flush-Glazed Grille Locations

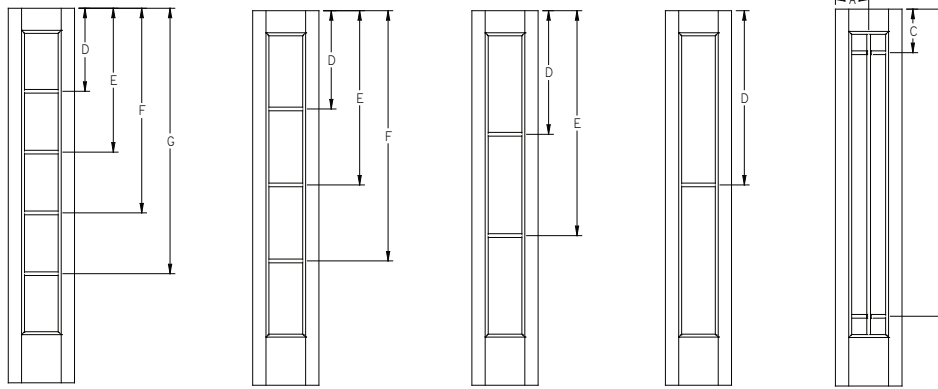

GBG/SDL - Flush-Glazed - Smooth-Star - 6'8" Full Lite Sidelite - 1W5H

Panel	Glass	A	B	C	D	E	F	G
12	7 x 64	-	-	-	17-9/16"	30-5/16"	43-1/8"	55-15/16"
14	7 x 64	-	-	-	17-9/16"	30-5/16"	43-1/8"	55-15/16"

GBG/SDL - Flush-Glazed - Fiber Classic - 6'8" Full Lite Sidelite - 1W5H

Panel	Glass	A	B	C	D	E	F	G
12	8 x 64	-	-	-	17-5/8"	30-1/2"	43-5/16"	56-3/16"
14	8 x 64	-	-	-	17-5/8"	30-1/2"	43-5/16"	56-3/16"

Wood Grilles - Flush-Glazed - Fiber Classic - 6'8" Full Lite Sidelite - 1W5H

Panel	Glass	A	B	C	D	E	F	G
12"	8 x 64	-	-	-	17-13/16"	30-9/16"	43-1/4"	56"
14"	8 x 64	-	-	-	17-13/16"	30-9/16"	43-1/4"	56"

GBG - Flush-Glazed - Smooth-Star - 6'8" Full Lite Sidelite - 1W4H

Panel	Glass	A	B	C	D	E	F
12	7 x 64	-	-	-	20-3/4"	36-3/4"	52-3/4"
14	7 x 64	-	-	-	20-3/4"	36-3/4"	52-3/4"

GBG - Flush-Glazed - Fiber Classic - 6'8" Full Lite Sidelite - 1W4H

Panel	Glass	A	B	C	D	E	F
12	8 x 64	-	-	-	20-13/16"	36-15/16"	53"
14	8 x 64	-	-	-	20-13/16"	36-15/16"	53"

GBG - Flush-Glazed - Smooth-Star - 6'8" Full Lite Sidelite - 1W3H

Panel	Glass	A	B	C	D	E
12	7 x 64	-	-	-	26-1/16"	47-3/8"
14	7 x 64	-	-	-	26-1/16"	47-3/8"

GBG - Flush-Glazed - Fiber Classic - 6'8" Full Lite Sidelite - 1W3H

Panel	Glass	A	B	C	D	E
12	8 x 64	-	-	-	26-3/16"	47-5/8"
14	8 x 64	-	-	-	26-3/16"	47-5/8"

GBG - Flush-Glazed - Smooth-Star - 6'8" Full Lite Sidelite - 1W2H

Panel	Glass	A	B	C	D
12	7 x 64	-	-	-	36-3/4"
14	7 x 64	-	-	-	36-3/4"

GBG - Flush-Glazed - Fiber Classic - 6'8" Full Lite Sidelite - 1W2H

Panel	Glass	A	B	C	D
12	8 x 64	-	-	-	36-15/16"
14	8 x 64	-	-	-	36-15/16"

GBG - Flush-Glazed - Smooth-Star - 6'8" Full Lite Sidelite - 6 Lite Prairie

Panel	Glass	A	B	C	D
12	7 x 64	6"	-	9-3/16"	64-5/16"
14	7 x 64	7"	-	9-3/16"	64-5/16"

GBG - Flush-Glazed - Fiber Classic - 6'8" Full Lite Sidelite - 6 Lite Prairie

Panel	Glass	A	B	C	D
12	8 x 64	6"	-	9-3/16"	64-5/8"
14	8 x 64	7"	-	9-3/16"	64-5/8"

All dimensions shown are to the center of the muntin.

6/8 Flush-Glazed Grille Locations

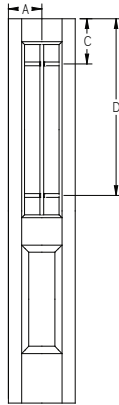
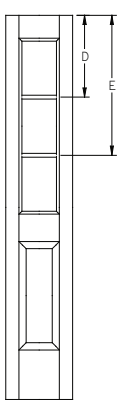

GBG/SDL - Flush-Glazed - Fiber Classic - 6'8" Half Lite Sidelite - 1W3H

Panel	Glass	A	B	C	D	E
12	8 x 36	-	-	-	16-7/8"	28-15/16"
14	8 x 36	-	-	-	16-7/8"	28-15/16"

Wood Grilles - Flush-Glazed - Fiber Classic - 6'8" Half Lite Sidelite - 1W3H

Panel	Glass	A	B	C	D	E
12"	8 x 36	-	-	-	17"	28-13/16"
14"	8 x 36	-	-	-	17"	28-13/16"

GBG - Flush-Glazed - Fiber Classic - 6'8" Half Lite Sidelite - 6 Lite Prairie

Panel	Glass	A	B	C	D
12	8 x 36	6"	-	9-3/16"	36-5/8"
14	8 x 36	7"	-	9-3/16"	36-5/8"

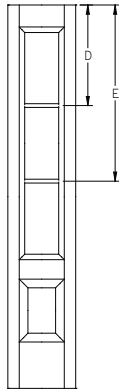
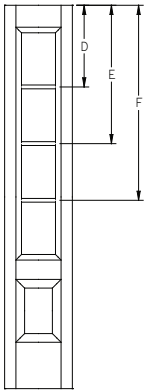

GBG - Flush-Glazed - Smooth-Star - 6'8" 3/4 Lite Sidelite - 1W4H

Panel	Glass	A	B	C	D	E	F
12	8 x 47	-	-	-	16-7/8"	28-5/8"	40-5/16"
14	8 x 47	-	-	-	16-7/8"	28-5/8"	40-5/16"

Wood Grilles - Flush-Glazed - Fiber Classic - 6'8" 3/4 Lite Sidelite - 1W4H

Panel	Glass	A	B	C	D	E	F
12"	8 x 47	-	-	-	17-1/16"	28-5/8"	40-3/16"
14"	8 x 47	-	-	-	17-1/16"	28-5/8"	40-3/16"

GBG - Flush-Glazed - Smooth-Star - 6'8" 3/4 Lite Sidelite - 1W3H

Panel	Glass	A	B	C	D	E
12	8 x 47	-	-	-	20-13/16"	36-7/16"
14	8 x 47	-	-	-	20-13/16"	36-7/16"

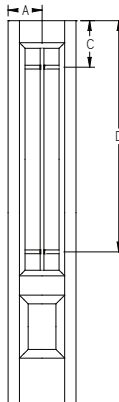
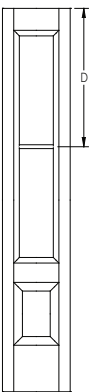

GBG - Flush-Glazed - Smooth-Star - 6'8" 3/4 Lite Sidelite - 1W2H

Panel	Glass	A	B	C	D
12	8 x 47	-	-	-	28-5/8"
14	8 x 47	-	-	-	28-5/8"

GBG - Flush-Glazed - Smooth-Star - 6'8" 3/4 Lite Sidelite - 6 Lite Prairie

Panel	Glass	A	B	C	D
12	8 x 47	6"	-	9-5/8"	47-5/8"
14	8 x 47	7"	-	9-5/8"	47-5/8"

All dimensions shown are to the center of the muntin.

8'0 Flush-Glazed Grille Locations

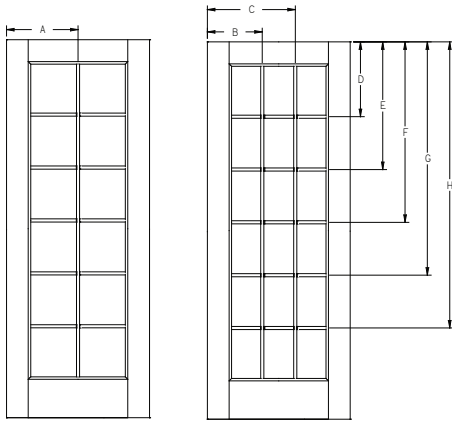

GBG - Flush-Glazed - Smooth-Star - 8'0" Full Lite - 3W6H and 2W6H

Panel	Glass	A	B	C	D	E	F	G	H
2/6	21 x 80	15"	11-1/2"	18-1/2"	18-7/8"	32-1/4"	45-9/16"	58-7/8"	72-1/4"
2/8	21 x 80	16"	12-1/2"	19-1/2"	18-7/8"	32-1/4"	45-9/16"	58-7/8"	72-1/4"
2/10	25 x 80	17"	12-13/16"	21-3/16"	18-7/8"	32-3/16"	45-9/16"	58-7/8"	72-3/16"
3/0	25 x 80	18"	13-13/16"	22-3/16"	18-7/8"	32-3/16"	45-9/16"	58-7/8"	72-3/16"

Wood Grilles - Flush-Glazed - Smooth-Star - 8'0" Full Lite - 3W6H and 2W6H

Panel	Glass	A	B	C	D	E	F	G	H
2/6	21 x 80	15"	11-5/8"	18-3/8"	19-1/8"	32-3/8"	45-9/16"	58-3/4"	72"
2/8	21 x 80	16"	12-5/8"	19-3/8"	19-1/8"	32-3/8"	45-9/16"	58-3/4"	72"
2/10	25 x 80	17"	12-15/16"	21-1/16"	19-1/8"	32-5/16"	45-9/16"	58-3/4"	71-15/16"
3/0	25 x 80	18"	13-15/16"	22-1/16"	19-1/8"	32-5/16"	45-9/16"	58-3/4"	71-15/16"

GBG - Flush-Glazed - Fiber Classic - 8'0" Full Lite - 3W6H and 2W6H

Panel	Glass	A	B	C	D	E	F	G	H
2/6	21 x 80	15"	11-1/2"	18-1/2"	18-7/8"	32-1/4"	45-9/16"	58-7/8"	72-1/4"
2/8	21 x 80	16"	12-1/2"	19-1/2"	18-7/8"	32-1/4"	45-9/16"	58-7/8"	72-1/4"
2/10	25 x 80	17"	12-13/16"	21-3/16"	18-7/8"	32-1/4"	45-9/16"	58-7/8"	72-1/4"
3/0	25 x 80	18"	13-13/16"	22-3/16"	18-7/8"	32-1/4"	45-9/16"	58-7/8"	72-1/4"

Wood Grilles - Flush-Glazed - Fiber Classic - 8'0" Full Lite - 3W6H and 2W6H

Panel	Glass	A	B	C	D	E	F	G	H
2/6	21 x 80	15"	11-5/8"	18-3/8"	19-1/8"	32-3/8"	45-9/16"	58-3/4"	72"
2/8	21 x 80	16"	12-5/8"	19-3/8"	19-1/8"	32-3/8"	45-9/16"	58-3/4"	72"
2/10	25 x 80	17"	12-15/16"	21-1/16"	19-1/8"	32-3/8"	45-9/16"	58-3/4"	72"
3/0	25 x 80	18"	13-15/16"	22-1/16"	19-1/8"	32-3/8"	45-9/16"	58-3/4"	72"

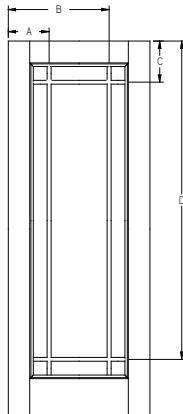

GBG - Flush-Glazed - Smooth-Star - 8'0" Full Lite - 9 Lite Prairie

Panel	Glass	A	B	C	D
2/0	14 x 80	9-7/16"	14-9/16"	10"	81-1/8"
2/6	21 x 80	8-15/16"	21-1/16"	10"	81-1/8"
2/8	21 x 80	10-15/16"	21-1/16"	10"	81-1/8"
2/10	25 x 80	10-15/16"	23-1/16"	10"	81-1/8"
3/0	25 x 80	12-15/16"	23-1/16"	10"	81-1/8"

GBG - Flush-Glazed - Fiber Classic - 8'0" Full Lite - 9 Lite Prairie

Panel	Glass	A	B	C	D
2/0	14 x 80	9-7/16"	14-9/16"	10"	81-1/8"
2/6	21 x 80	8-15/16"	21-1/16"	10"	81-1/8"
2/8	21 x 80	10-15/16"	21-1/16"	10"	81-1/8"
2/10	25 x 80	10-15/16"	23-1/16"	10"	81-1/8"
3/0	25 x 80	12-15/16"	23-1/16"	10"	81-1/8"

All dimensions shown are to the center of the muntin.

8/0 Flush-Glazed Grille Locations

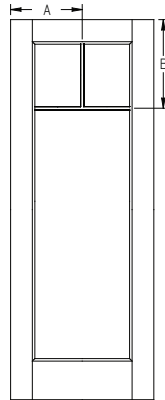

GBG/SDL - Flush-Glazed - Smooth-Star - 8'0" Full Lite Craftsman - 2W1H

Panel	Glass	A	B
2/0	14 x 64	12"	21-1/8"
2/6	21 x 64	15"	21-1/8"
2/8	21 x 64	16"	21-1/8"
2/10	25 x 64	17"	21-1/8"
3/0	25 x 64	18"	21-1/8"

GBG/SDL - Flush-Glazed - Fiber Classic - 8'0" Full Lite Craftsman - 2W1H

Panel	Glass	A	B
2/0	14 x 64	12"	21-1/8"
2/6	21 x 64	15"	21-1/8"
2/8	21 x 64	16"	21-1/8"
2/10	25 x 64	17"	21-1/8"
3/0	25 x 64	18"	21-1/8"

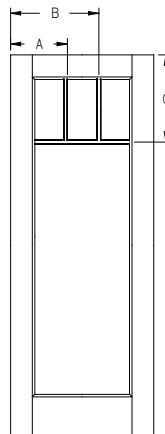

GBG/SDL - Flush-Glazed - Smooth-Star - 8'0" Full Lite Craftsman - 3W1H

Panel	Glass	A	B	C
2/0	14 x 64	10-1/8"	13-7/8"	21-1/8"
2/6	21 x 64	11-1/2"	18-1/2"	21-1/8"
2/8	21 x 64	12-1/2"	19-1/2"	21-1/8"
2/10	25 x 64	12-13/16"	21-3/16"	21-1/8"
3/0	25 x 64	13-13/16"	22-3/16"	21-1/8"

GBG/SDL - Flush-Glazed - Fiber Classic - 8'0" Full Lite Craftsman - 3W1H

Panel	Glass	A	B	C
2/0	14 x 64	10-1/8"	13-7/8"	21-1/8"
2/6	21 x 64	11-1/2"	18-1/2"	21-1/8"
2/8	21 x 64	12-1/2"	19-1/2"	21-1/8"
2/10	25 x 64	12-13/16"	21-3/16"	21-1/8"
3/0	25 x 64	13-13/16"	22-3/16"	21-1/8"

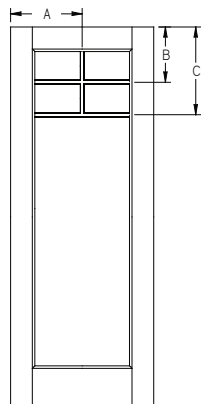

GBG/SDL - Flush-Glazed - Smooth-Star - 8'0" Full Lite Craftsman - 2W2H

Panel	Glass	A	B	C
2/0	14 x 64	12"	13-5/16"	21-1/8"
2/6	21 x 64	15"	13-5/16"	21-1/8"
2/8	21 x 64	16"	13-5/16"	21-1/8"
2/10	25 x 64	17"	13-5/16"	21-1/8"
3/0	25 x 64	18"	13-5/16"	21-1/8"

GBG/SDL - Flush-Glazed - Fiber Classic - 8'0" Full Lite Craftsman - 2W2H

Panel	Glass	A	B	C
2/0	14 x 64	12"	13-5/16"	21-1/8"
2/6	21 x 64	15"	13-5/16"	21-1/8"
2/8	21 x 64	16"	13-5/16"	21-1/8"
2/10	25 x 64	17"	13-5/16"	21-1/8"
3/0	25 x 64	18"	13-5/16"	21-1/8"

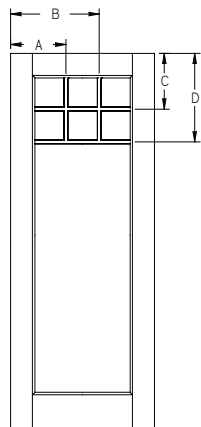

GBG/SDL - Flush-Glazed - Smooth-Star - 8'0" Full Lite Craftsman - 3W2H

Panel	Glass	A	B	C	D
2/0	14 x 64	10-1/8"	13-7/8"	13-5/16"	21-1/8"
2/6	21 x 64	11-1/2"	18-1/2"	13-5/16"	21-1/8"
2/8	21 x 64	12-1/2"	19-1/2"	13-5/16"	21-1/8"
2/10	25 x 64	12-13/16"	21-3/16"	13-5/16"	21-1/8"
3/0	25 x 64	13-13/16"	22-3/16"	13-5/16"	21-1/8"

GBG/SDL - Flush-Glazed - Fiber Classic - 8'0" Full Lite Craftsman - 3W2H

Panel	Glass	A	B	C	D
2/0	14 x 64	10-1/8"	13-7/8"	13-5/16"	21-1/8"
2/6	21 x 64	11-1/2"	18-1/2"	13-5/16"	21-1/8"
2/8	21 x 64	12-1/2"	19-1/2"	13-5/16"	21-1/8"
2/10	25 x 64	12-13/16"	21-3/16"	13-5/16"	21-1/8"
3/0	25 x 64	13-13/16"	22-3/16"	13-5/16"	21-1/8"

All dimensions shown are to the center of the muntin.

Vinyl Sliding Patio Doors

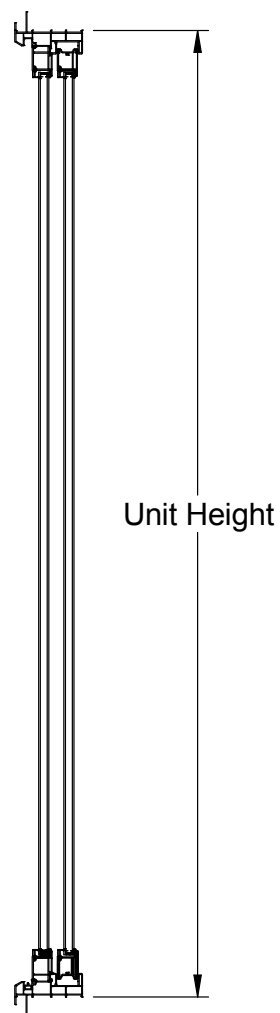
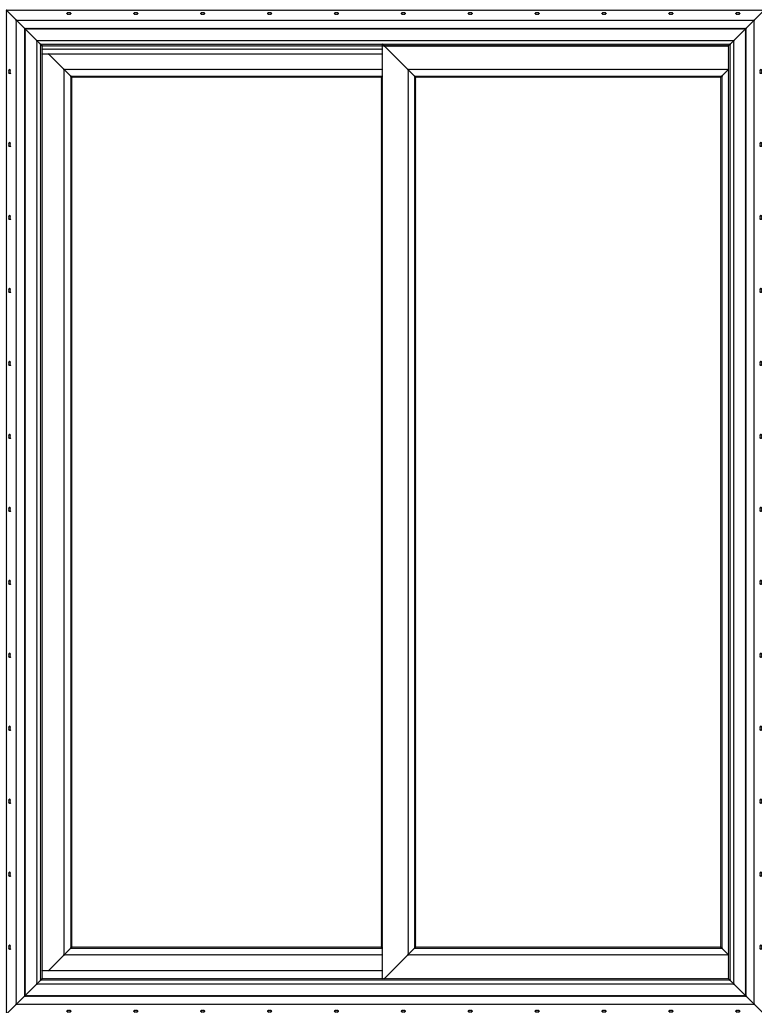
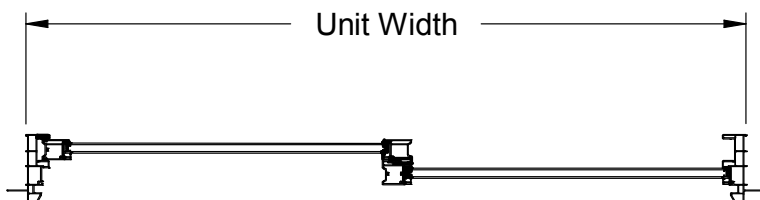

Vinyl Sliding Patio Doors

Replacement Height 1-Lite

Single

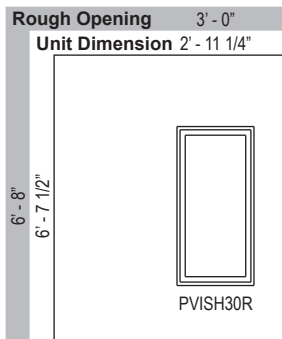

Double

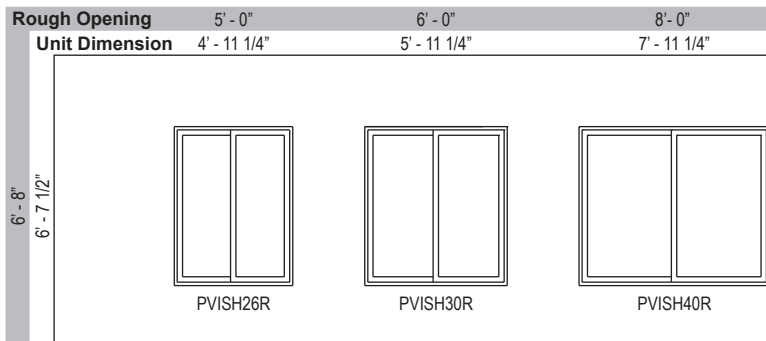

Triple

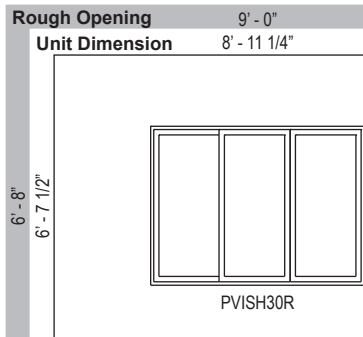

Scale: 1/8" = 1'0"

Part Number Key

PVISHZZRP - P DLS G T F

(Example: PVISFRF30RS-PL01CNW)

P Patio

VI VI = Vinyl Patio

S Slider

H Hand Designation
F = Fixed
L = Left
R = Right

ZZ Panel Width
26 = 2/6
30 = 3/0
40 = 4/0

R Panel Height
R = Replacement

P Performance Grade
S = Standard
H = High Performance

P P = Prehung

DLS Door Lite Style
L01 = 1 Lite
F9P = 9 Lite (Flat Bar)
F10 = 10 Lite (Flat Bar)
F15 = 15 Lite (Flat Bar)
C9P = 9 Lite (Contoured)
C10 = 10 Lite (Contoured)
C15 = 15 Lite (Contoured)

G Glazing Performance
C = Clear Glass (Air Filled)
E = Low E (270) - (Argon Filled)
3 = Low E (366) - (Argon Filled)

T Tint Option
N = No Tint
G = Gray Tint
B = Bronze Tint

F Unit Finish
T = Stone
A = Almond
W = White

Hand Designations (Viewed from the exterior)

F Fixed Panel
L Left Hand
R Right Hand

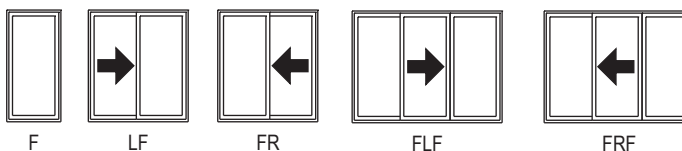

Vinyl Sliding Patio Doors - Panel Size

Unit	Panel Width	Panel Height	Daylight Width	Daylight Height
2/6 Replacement Ht.	30-1/4"	76-1/4"	25-1/2"	71-1/2"
3/0 Replacement Ht.	36-1/4"	76-1/4"	31-1/2"	71-1/2"
4/0 Replacement Ht.	48-1/4"	76-1/4"	43-1/2"	71-1/2"

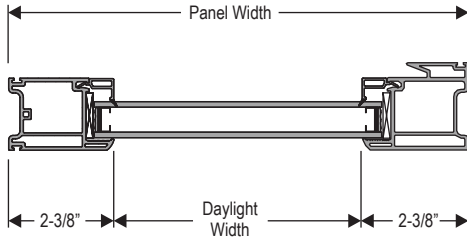

HORIZONTAL PANEL SECTION
Scale: 3" = 1'

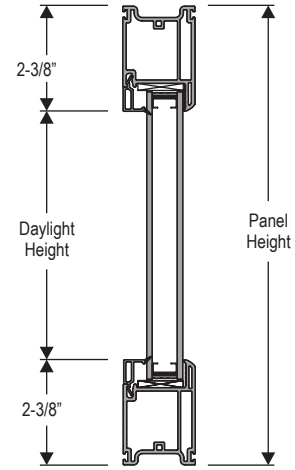

VERTICAL PANEL SECTION
Scale: 3" = 1'

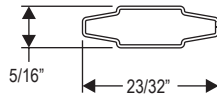

GRILLE SECTION
Scale: 1:1

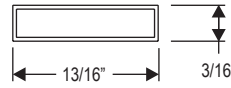

GRILLE SECTION
Scale: 1:1

Vinyl Sliding Patio Doors

Unit	Sq. Ft. Daylight Opening	Clear Opening Width	Clear Opening Height	Sq. Ft. Clear Opening
PVISF30R	15.64	---	---	---
PVIS(LF/RF)26R	25.32	25"	76-1/8"	13.21
PVIS(LF/RF)30R	31.28	31"	76-1/8"	16.38
PVIS(LF/RF)40R	43.19	43"	76-1/8"	22.73
PVIS(FLF/FRF)30R	46.92	31"	76-1/8"	16.38

Vinyl Sliding Patio Doors

Grille Locations

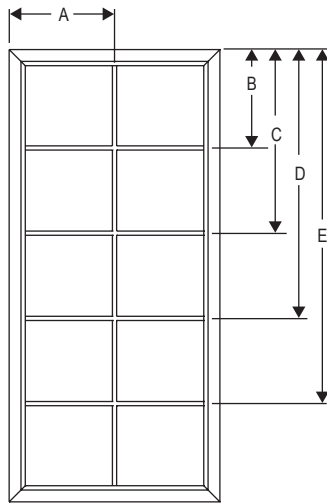

Vinyl Replacement Height 10- Lite Grille Location

Unit	A	B	C	D	E
PVIS26R	15-1/8"	16-3/4"	31-1/16"	45-3/8"	59-11/16"
PVIS30R	18-1/8"	16-3/4"	31-1/16"	45-3/8"	59-11/16"

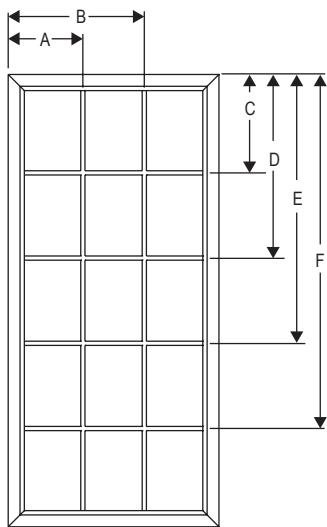

Vinyl Replacement Height 15- Lite Grille Location

Unit	A	B	C	D	E	F
PVIS26R	15-1/8"	19-7/16"	16-3/4"	31-1/16"	45-3/8"	59-11/16"
PVIS30R	18-1/8"	23-7/16"	16-3/4"	31-1/16"	45-3/8"	59-11/16"

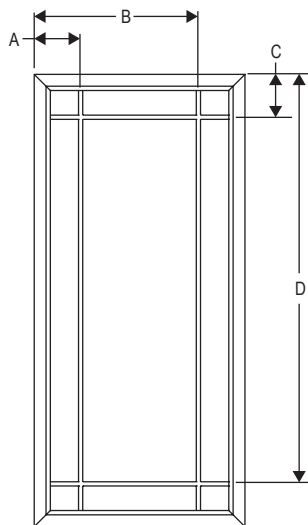

Vinyl Replacement Height 10- Lite Grille Location

Unit	A	B	C	D
PVIS26R	6-29/64"	15-59/64"	6-29/64"	72"
PVIS30R	6-29/64"	31-59/64"	6-29/64"	72"

Vinyl Sliding Patio Doors

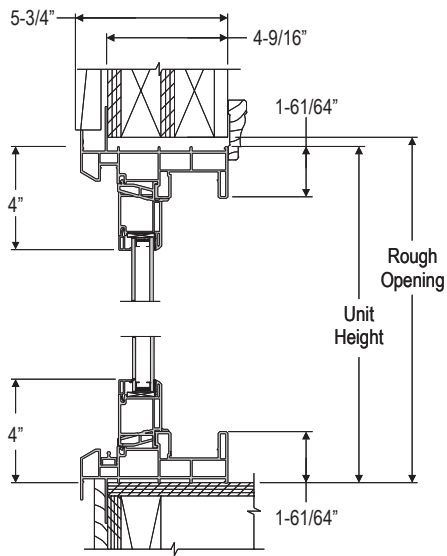

VERTICAL SECTION - SINGLE

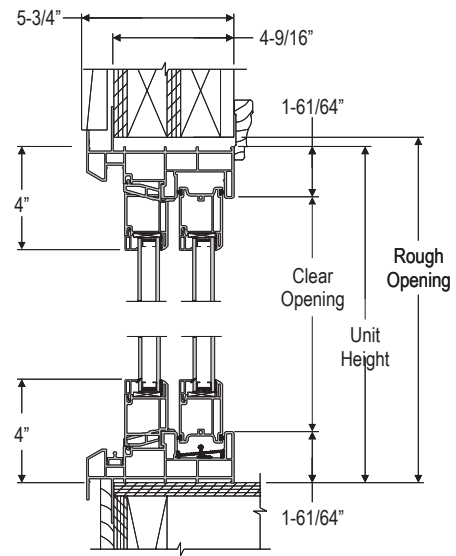

VERTICAL SECTION - ALL OTHERS

