

Tools for

THERMA TRU
DOORS

SUCCESS

2017 Product Merchandising Brochure



Showroom | Trade Shows | Visualization | Literature | Advertising

See it. Feel it. Sell it.

Displays | Signage | Samples | Training | Wearables | Handouts

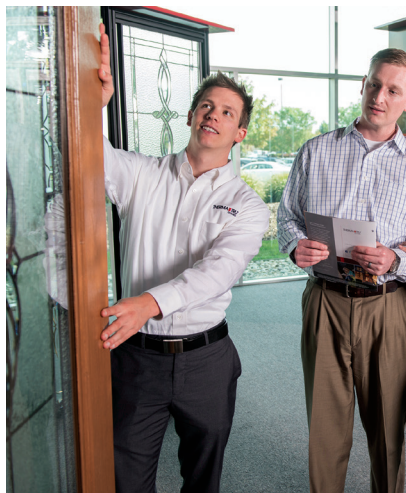
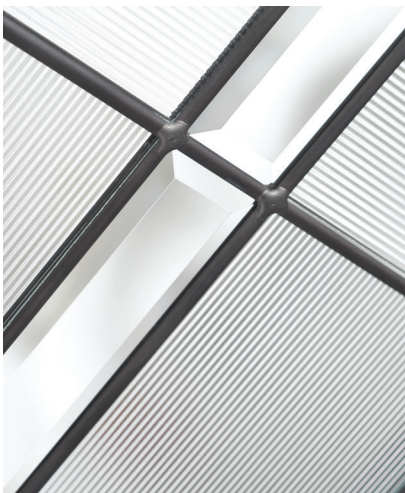

Table of Contents

Glass Displays	4-7
Door Displays	8-13
Display Door Signage	13-15
Showroom Signage	15-17
Product Samples	18-23
Literature	24-25
Custom Marketing Program	26
Training Aids & Documents	27
Technical Documents	28
Sell Sheet & Door Signage Templates	28
Company Store	29
Digital Tools	30-31

Please visit www.thermatru.com/merchandising for a digital copy of this brochure.

Distributors: Please contact your dedicated Customer Account Representative to order the products shown in this brochure.

Dealers: If you are interested in the following support materials, please contact a Therma-Tru distributor in your area to place an order.

The support you need for showroom success.

A solid partnership depends on support. Let us help you design your showroom and equip your staff to sell the value of Therma-Tru® doors.

What's **NEW** in the showroom.

Lite Display Unit Glass Labels | Page 5

Showroom TV with Glass Images | Page 6

Pivot Wing Display Unit | Page 11

Display Feet | Page 12

Therma-Tru Brand (Gray) Header Sign | Page 13

Door Pulls | Page 13

DoorWays™ App Label | Page 15

Vinyl Banners | Page 16

Posters | Pages 16-17

Double-Sided Flush-Glazed Door Sections | Page 18

Side-by-Side Display Carrying Case | Page 19

Quarter Doors & Door Skin Samples | Page 20

System Storyboard | Page 21

Glass Sample Case | Page 21

Literature | Pages 24-25

- 2017 Full-Line Catalog
- 2017 Decorative & Specialty Glass Collection Brochure
- 2017 Pulse Brochure
- 2017 New Product Flyers
- 2017 Fiberglass & Wood Door Comparison Brochure
- Architectural Home Styles Guide
- 3'6" Entry Door Solutions Brochure
- Flush-Glazed Doors Brochure

Unit Dimension Tape Measures | Page 27

2017 Technical Manuals | Page 28

Sell Sheet Templates | Page 28

Digital Tools | Pages 30-31

- Therma-Tru's Digital Vault
- Architectural Home Styles Guide
- Dealer Microsite Landing Pages
- EasySpec™ Drawing Tools

Display Terms: Pricing on the display stands and door systems are subject to change without notice. Refer to your Customer Account Representative for lead times on displays. Freight is an additional cost and varies dependent on order and ship-to location. Displays must be shipped with full trucks direct to distributor. Entry door systems and display doors may **not** be purchased without display structures.

Tools for showroom success: See it. Feel it. Sell it.

The showroom experience plays an important role in the purchase decision. The showroom is where your customers can see and feel the products you offer firsthand. And it's where they can talk to your knowledgeable sales staff.

In this brochure, you'll find the selling and training tools you need to help create a successful showroom experience. Let your customers see how a stylish new Therma-Tru® entry door can add curb appeal to their home. And let them feel the exceptional quality in every detail.

Now is the time to think about the showroom experience you want to create. What tools do you need to help your customers experience the Therma-Tru difference?

Let your customers see and
feel the difference.



Lite Display Unit

This display is a great way to showcase the many elegant designs of Therma-Tru® glass, while demonstrating firsthand the level of privacy offered by these glass designs.



Lite Display Unit

Glass not included.

MADGLDU15

Flexible design holds seven (7) or more rectangular doorlites that can easily be changed. Display unit utilizes open space with options to configure in a Z- or U-shape to encourage shopper interaction. Header sign, graphic panel with messaging and Therma-Tru labels included.

- Each section is height- and width-adjustable to accommodate certain lite sizes.
- Choose from flexible options to fit the styles your market demands.

- ① Z-Shaped: 4'1" w x 8'2" h x 6'6" d
- ② U-Shaped: 4'1" w x 8'2" h x 4'0" d

Net Price Each*: \$2,290.00

Note: Not recommended for fan lite, camber top, oval or arch glass shapes.

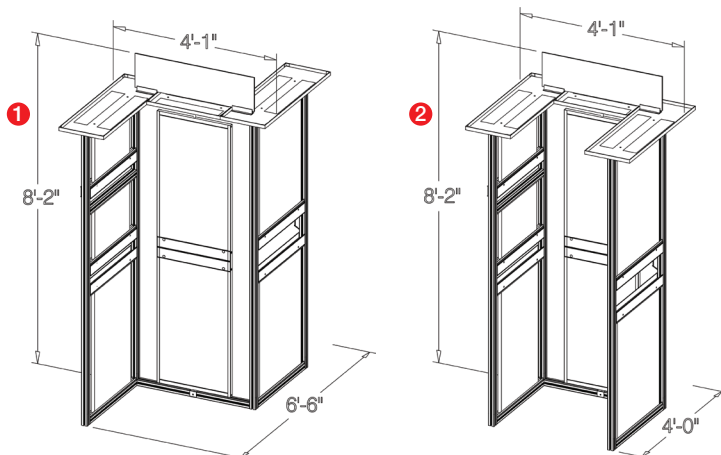

*Pricing subject to change without notice.

③ Classic-Craft Center Expansion

MADGLDU16-CR

Uses adjustable hardware allowing Classic-Craft glass to be shown in the center rotating section of the unit. Includes Therma-Tru labels, as well as labels for every Classic-Craft glass design.

Net Price Each*: \$310.00

④ Crossbar Separator for Smaller Lites

MADGLDU16-CBS

Allows for many glass height display options, so you can display the glass sizes your market demands.

Net Price Each*: \$260.00

Note: Artist's renderings shown for illustration purposes only.

Recommended Glass Lites

Customize your display to show the glass designs and sizes your customers want. Choose our recommended selection below. Or work with your distributor to display the best glass lites to suit your market.



**Riserva™
Wrought Iron**
22" w x 36" h
Fiber-Classic.
Mahogany Collection™
Fiber-Classic.
Oak Collection™
Smooth-Star.



**Sedona
Black Nickel**
22" w x 36" h
Fiber-Classic.
Mahogany Collection™
Fiber-Classic.
Oak Collection™
Smooth-Star.



**Wellesley™
Black Nickel**
22" w x 36" h
Fiber-Classic.
Mahogany Collection™
Fiber-Classic.
Oak Collection™
Smooth-Star.

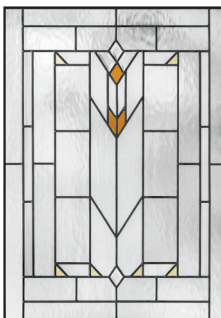

**Arborwatch.
Black Nickel**
25" w x 35" h
Classic-Craft.
Mahogany Collection™
Classic-Craft.
Rustic Collection™
Classic-Craft.
Oak Collection™
Classic-Craft.
Canvas Collection.



**Homeward™
Black Nickel**
25" w x 35" h
Classic-Craft.
Mahogany Collection™
Classic-Craft.
Rustic Collection™
Classic-Craft.
Oak Collection™
Classic-Craft.
Canvas Collection.



**Maple Park.
Black Nickel**
21" w x 15" h
Fiber-Classic.
Mahogany Collection™
Fiber-Classic.
Oak Collection™
Smooth-Star.



**Axis™
Black Nickel**
21" w x 15" h
Fiber-Classic.
Mahogany Collection™
Fiber-Classic.
Oak Collection™
Smooth-Star.
Pulse.

Description	Part Number	Net Price Each*
Glass Lite Package: 22" w x 36" h Riserva glass – Wrought Iron 25" w x 35" h Arborwatch glass – Black Nickel 25" w x 35" h Homeward glass – Black Nickel 22" w x 36" h Sedona glass – Black Nickel 22" w x 36" h Wellesley glass – Black Nickel 21" w x 15" h Maple Park glass – Black Nickel 21" w x 15" h Axis glass – Black Nickel	MADGLDGS17	\$900.00

Use Part #MADGLDGS17 to order all seven (7) glass lites shown above for placement in the Lite Display Unit on page 4. Includes labels for each glass design shown.

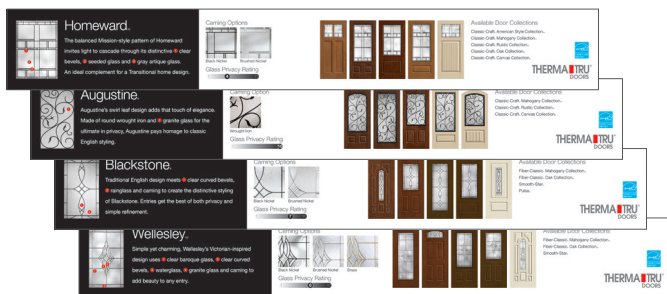

NEW Lite Display Unit Glass Labels

MADGLDLBL17

Includes a label for every Therma-Tru® glass family. Show a label for each glass design you choose to display on one side of the unit. And show the Therma-Tru labels included with the unit on the other side.

Net Price Each*: \$85.00

Triangular Glass Display



Triangular Glass Display

47-1/2"w x 7'10"h x 46-3/4"d

You can buy the complete three-sided display and customize it to fit your needs. Choose just a portion of it to mount on a pullout door display or swing door unit. Or buy with an attachment kit that lets you incorporate sidelites from your own inventory.

Option 1

MADGLFRAMESIDELITES15
Complete three-sided display (finished).

Net Price Each*: \$2,800.00

Option 2

MADGLFRAMECRAFT15
Single side for mounting on pullout door display or swing unit door (glass only).

Net Price Each*: \$1,000.00

Option 3

MASIDELITEATTACH13
Attachment kit for sidelites.

Net Price Each*: \$85.00

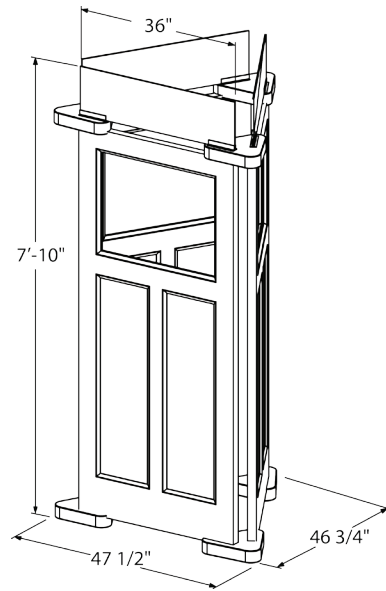

NEW Showroom TV with Glass Images

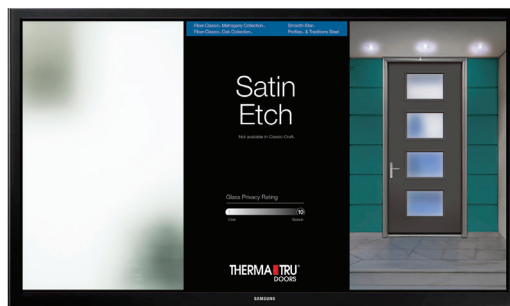

42" TV with USB Flash Drive

MAD42TVUSB13

Package includes 42" TV with wall mount and USB flash drive featuring vertical and horizontal images of Therma-Tru glass families and messaging on continuous loop.

Net Price Each*: \$595.00

USB Flash Drive Only

MADUSB15

USB flash drive featuring vertical and horizontal images of Therma-Tru glass families and messaging on continuous loop.

Net Price Each*: \$15.00

*Pricing subject to change without notice.

**Data charges may apply. The customer is responsible for any charges on their data plan.

Note: Artist's renderings shown for illustration purposes only.

Interactive Glass Display



Interactive Glass Display

MADINTERGLASSDISPLAY15

4'0" w x 8'3" h x 2'8" d

- 50" commercial grade LED television.
- Finished Classic-Craft[™] Mahogany Collection[™] door.
- Pre-programmed tablet to view glass designs, coming options, privacy ratings, glass shapes and available door collections.
- Current glass can be shown and preferred glass designs can be shared via email (when connected to Wi-Fi).**
- Wall-mount hardware or choose optional free-standing kit of display feet and back panel (see right).
- Header and side panel graphics included.

Net Price Each*: \$2,725.00



Free-Standing Kit

MADINTERGLASSFREESTAND

4'0" w x 8'3" h x 2'8" d

An optional kit to turn your new interactive glass display into a free-standing showstopper on the showroom floor. Includes a black back panel applied by brackets to hide any cords and a set of durable display feet.

Net Price Each*: \$285.00

Door System Unit

These beautiful, fully functional door displays allow customers to experience Therma-Tru® doors in their best light and visualize how they will look on their home. With several door systems to choose from, you can display the styles that fit your showroom and market needs.



Note: Door System Unit is designed to fit doors up to 96" h only.

See your Therma-Tru seller to verify structure width options.

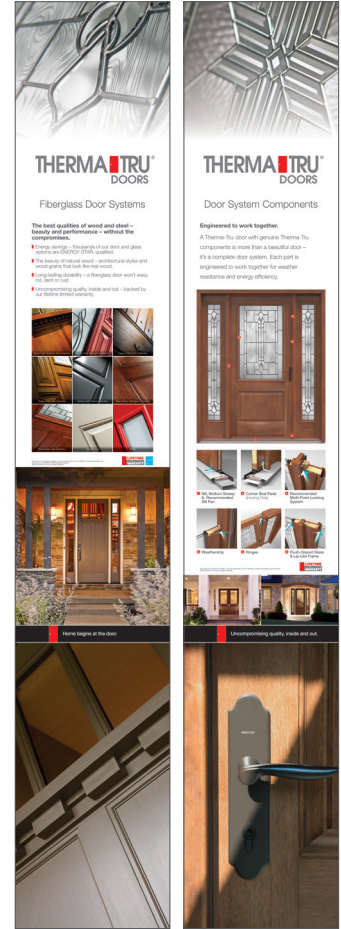

Graphic Panels (included)

- Therma-Tru
- Componentets

Doors not included.

MADGDSU15

11'7" w x 9'4" h x 4'5" d

- Fully operational display gives shoppers the most realistic Therma-Tru door experience.
- Adjusts from 44-1/2" to 68-1/2" to show multiple door configurations.
- Includes space to show a transom or the façade filler graphic of your choice.
- Features rotating graphic panels with messaging on one side and the exterior façade option of your choice on the other.

Net Price Each*: \$3,000.00

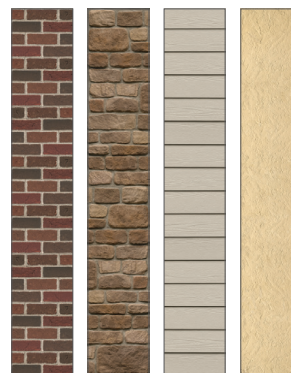
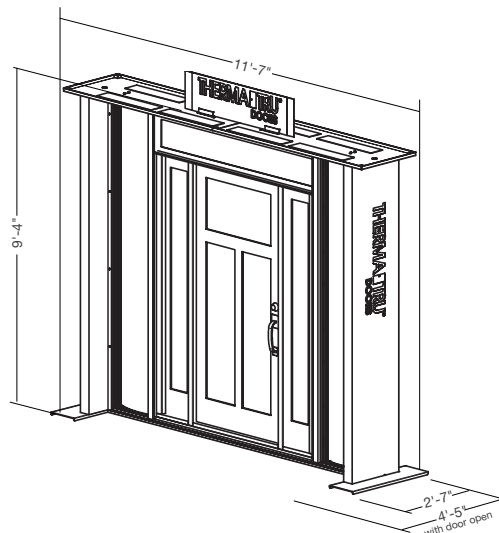

Façade Panels (Unit includes 2 panels of one texture choice, may order additional panels.)

- Brick
- Stone
- Siding
- Stucco

Description	Part Number
Brick Façade: Two (2) panels.	MADGBRIG15
Stone Façade: Two (2) panels.	MADGSTOG15
Siding Façade: Two (2) panels.	MADGSIDG15
Stucco Façade: Two (2) panels.	MADGSTUG15

Note: Façades are no cost items and come with one (1) Therma-Tru graphic panel and one (1) components graphic panel.

*Pricing subject to change without notice.

Note: Artist's renderings shown for illustration purposes only. For custom, pre-finished door displays, contact your Therma-Tru representative to place an order.

Entry Door System Options

The unit allows you to choose your style and configuration, but here are some recommendations to spruce up your showroom.



Classic-Craft. Mahogany

Longford – Black Nickel
 Heirloom Wide Handleset – Black Nickel
 Walnut Stain
 MADGCCM203-0214ELIPTR-16
Net Price Each*: \$3,250.00



Classic-Craft. Rustic

Borrassa – Wrought Iron Sidelite – Hammered Glass
 Heirloom Narrow Handleset – Black Nickel
 Walnut Stain
 MADGCCR1511-0114-16
Net Price Each*: \$2,500.00

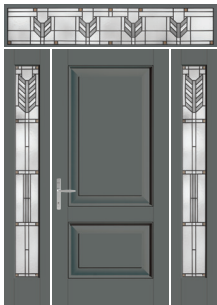

Classic-Craft. Canvas

Millennium Narrow Handleset – Brushed Nickel
 Paint – SW 2848 Roycroft Pewter
 MADGCCV200-0214TR-16
Net Price Each*: \$2,600.00



Pulse. Línea

Mahogany-Grained Fiberglass
 Avonlea – Black Nickel
 Venture Narrow Handleset – Oil-Rubbed Bronze
 Walnut Stain; Frame Paint – SW 6991 Black Magic
 MADFCM1LAV-DOUBLE-16
Net Price Each*: \$2,500.00



Fiber-Classic. Oak

Riserva – Wrought Iron
 Venture Wide Handleset – Black Nickel
 Cherry Stain
 MADGFC574-0214-16
Net Price Each*: \$2,800.00



Smooth-Star.

Rainglass Privacy & Textured Glass with SDLs
 Millennium Narrow Handleset – Brushed Nickel
 Paint – SW 0047 Studio Blue Green
 MADGS4813XR-SDLF1-0214-16
Net Price Each*: \$2,800.00

Options to Update Existing Units

Choose from the following options to update your existing Door System Unit. Replacement Façade Panels also available upon request (see page 8 for options).

Adjustable Jig

MADGDSU16-AJ

Display a variety of sizes and configurations that suit your market demand including adding sidelites or transoms.

Adjustable Width Options

Net Price Each*: \$350.00



Receive a rebate of \$200 when you follow the package instructions provided with the Adjustable Jig and contact Customer Service at orders@thermatru.com with the pertinent order information.

Rectangular Transom Filler

When choosing not to use a transom, select a façade filler to complete your unit.

Net Price Each*: \$110.00



Description	Part Number
Brick Façade	MADGBRIG15-NTFF
Stone Façade	MADGSTOG15-NTFF
Siding Façade	MADGSIDG15-NTFF
Stucco Façade	MADGSTUG15-NTFF

Elliptical Transom Fillers

When showing an elliptical transom, use the filler of your choice to complete the unit with just the right finishing touch.

Net Price Each*: \$250.00



Description	Part Number
Brick Façade	MADGBRIG15-TFF
Stone Façade	MADGSTOG15-TFF
Siding Façade	MADGSIDG15-TFF
Stucco Façade	MADGSTUG15-TFF

Expandable Pullout Door Display Unit

Showcase the beauty of Therma-Tru® doors with a compact pullout door display that can be easily customized to fit your needs. Standard unit holds four (4) display doors and can be expanded to hold up to ten (10) display doors that pull out approximately 33" for easy viewing.

Configure it to fit your space.

- **Against a Wall** – Place the unit against a wall to create a gallery of display doors.
- **Free-Standing** – Set up your unit as a free-standing display and make it the center of attention.
- **Side-by-Side / Back-to-Back** – Place two units side by side or back to back to create an impressive exhibit of display doors.
- **Recessed** – Save even more floor space by building the display into a wall for a customized look in your showroom.



8'0" Pullout Door Display Unit

Doors and signage not included.

MAD8TALLPULL15

Standard unit holds four (4) 8'0" display doors and can expand to hold up to ten (10) 8'0" display doors. Unit can also accommodate 6'8" doors by ordering a spacer frame (not included).

Net Price Each*:
\$1,115.00

Note: Shown with additional door mounting hardware kits.

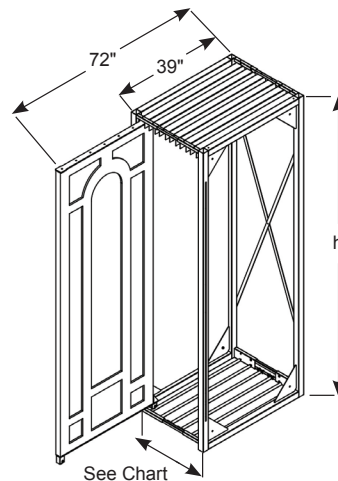

# of Doors	Unit Width
4	20"
5	24"
6	28"
8	36"
9	40"
10	44"

6'8" Unit: 7'4"h

8'0" Unit: 8'6-1/2"h



6'8" Pullout Door Display Unit

Doors and signage not included.

MAD68TALLPULL15

Standard unit holds four (4) 6'8" display doors and can expand to hold up to ten (10) 6'8" display doors.

Net Price Each*:
\$1,115.00

Optional Add-On Items:

Door Mounting Hardware Kit

MAD1DOORADDERPULL15

Allows one (1) additional 8'0" or 6'8" door to be installed in pullout door display.

Net Price Each*: \$130.00

1 Spacer Frame System

MADSPACERPULL15

For 6'8" door to fit 8'0" door display unit.

Net Price Each*: \$100.00

Side & Back Panels

Black panel (laminated particle board) to fit flush within metal frame, secured with provided hardware in pre-drilled display structure.

2 Side Panel (1 panel)

■ 8'0" Door Display Unit: MAD8TALLSIDEPULL15

■ 6'8" Door Display Unit: MAD68TALLSIDEPULL15

Back Panel (fits 10 door units only)

■ 8'0" Door Display Unit: MAD8TALLBACKPULL15

■ 6'8" Door Display Unit: MAD68TALLBACKPULL15

Net Price Each*: \$95.00

Select the pieces and parts you need to make it your own. For ordering information, or to obtain the display configurator tool with optional door pull hardware information, contact your Customer Account Representative.

*Pricing subject to change without notice.

Note: Artist's renderings shown with optional graphics and side panel for illustration purposes only.

NEW Pivot Wing Display Unit

Doors not included.

MADPWD17

90"w x 86-1/2" to 102-1/2"h x 14-1/2"d

Let customers easily browse your selection of Therma-Tru display doors while saving floor space in the showroom. The Pivot Wing Display Unit fits flush against the wall, offering a great way to organize more display doors. The doors fan open for customers to view all the options.

- Adjusts to show 6'8", 7'0" or 8'0" display doors.
- Display unit mounts to wall with supplied hardware.
- Door bumper guard mounts to top of display doors.
- Notched to clear standard baseboards.

Net Price Each*: \$650.00



Swing Door Unit

Showcase the beauty of Therma-Tru doors with a fully functioning swing display that can easily be customized to meet the demands of your market. Standard unit holds four (4) display doors and can be expanded to hold eight (8). Holds 6'8" and 8'0" doors.

Swing Door Unit
Doors not included.

MADGSWU15

6'6"w x 7'10"h x 4'6"d

Each door can swing up to 160 degrees for a wide viewing angle.

Net Price Each*: \$2,000.00

Expansion Kit
Doors not included.

MADGHKSU10

6'6"w x 7'10"h x 7'0"d

Optional hardware kit allows the unit to hold up to eight (8) display doors (4 on each side or 8 on one side).

Net Price Each*: \$300.00

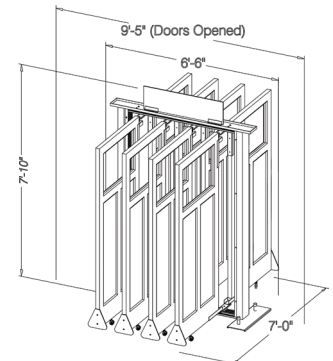
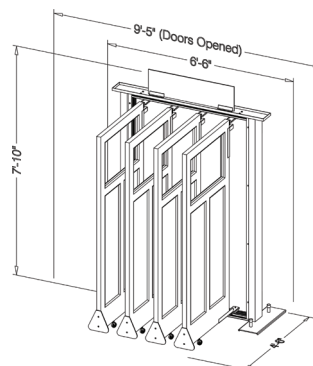

Single Operating Door Display

Doors not included.

MADSNGOPDR15

4'0"w x 8'3"h x 2'8"d

Order the display structure and dress it up with your offering. Use this display unit to showcase a Therma-Tru door with your finish, trim and hardware options. Removable caster wheels can be screwed into the base to help transport the display to shows and events.

Includes:

- Display fixture.
- Header sign.
- Side graphic panel.
- Levelers.
- Caster wheels.

Note: Fits doors that are 3'0"w x 6'8"h or smaller.

Net Price Each*: \$750.00

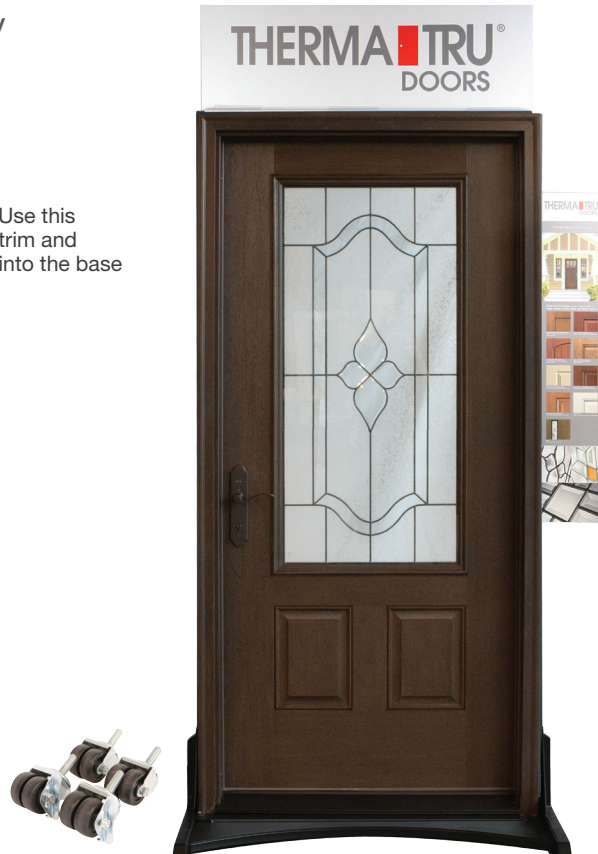

Display Door Stands

Revolver Slab Display

This set includes:

- 1 One (1) header sign.
- 2 Two (2) revolver face plate graphics.
- 3 One (1) revolver stand.

MADRS95 – 6'8" door

Net Price Each*: \$40.00

MADRS897 – 8'0" door

Net Price Each*: \$50.00



NEW Display Feet (Set of 2)

3-½"w x 4-½"h x 18"d

Maximize your space with this streamlined solution to display free-standing Therma-Tru doors in the showroom or at trade shows.



Solid Wood Display Feet

MADSWDISPFEEET

Net Price Each*: \$70.00



MDF Composite Display Feet

MADCOMPDISPFEEET

Net Price Each*: \$35.00

Three-Sided Display Stand

Doors not included.

MADDRSTAND

47-1/2" w x 7'10" h x 46-3/4" d

Let customers see and experience your Therma-Tru® door offering up close, with a door stand that conveniently displays multiple entry doors.

Showcase either three (3) 6'8" h or 8'0" h display doors using three (3) corner connectors that attach to top and bottom of doors.

Three (3) header signs included, (see right for options).

Net Price Each*: \$35.00

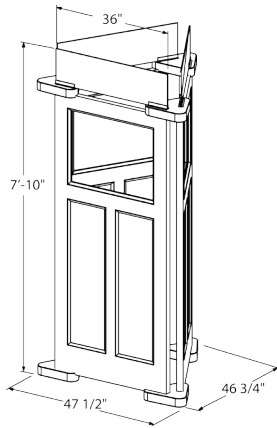

Header Signs



36" w x 10" h

Share the Therma-Tru story and sell more products. Add these header signs to your display doors and throughout your showroom.

Classic-Craft® Premium Entryways – MADHEADCC16

Fiber-Classic® Collections – MADHEADFC16

Smooth-Star® – MADHEADSS16

Pulse® – MADHEADPLS16

Therma-Tru® Brand (Black) – MADGHDR10

NEW Therma-Tru® Brand (Gray) – MADGHDR17

Net Price Each*: \$18.00

Header Sign Clips (sold separately) – MADGATTACHMENT

Net Price (Set of 2): \$1.69

NEW Door Pulls



All display doors ship with a plexicover and appropriate door pull graphic. Please reference the list below to order replacements.

Ask about custom imprint options when you order.

Classic-Craft® American Style Collection™ – MADCCADP17

Classic-Craft® Mahogany Collection™ – MADCCMDP17

Classic-Craft® Rustic Collection™ – MADCCRPD17

Classic-Craft® Oak Collection™ – MADCCODP17

Classic-Craft® Canvas Collection™ – MADCCVDP17

Fiber-Classic® Mahogany Collection™ – MADFCMDP17

Fiber-Classic® Oak Collection™ – MADFCODP17

Smooth-Star® – MADSSDP17

Profiles™ – MADPSHDDP17

Pulse® – MADPLSDP17

Internal Blinds – MADIBDP17

Flush-Glazed – MADFGDP17

Impact – MADIMPDP17

Net Price Each*: \$1.25

Graphic Plexicover (screws not included) – MAPLEXU

9-1/4" w x 17" h

Net Price Each*: \$5.00

*Pricing subject to change without notice.

Display Labels for Doors

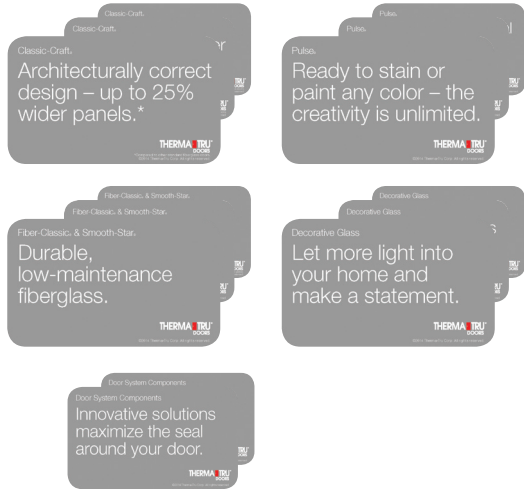

5" w x 3" h

Sets of three (3) low-tack adhesive labels call out features and benefits of display doors. Use one (1) set per door and stagger placement for the best look.

Classic-Craft. Labels (3-pack) – MADCCSTICKPK15

Systems Labels (3-pack) – MADCOMPSTICKPK15

Decorative Glass Labels (3-pack) – MADGLSSTICKPK15

Fiber-Classic® & Smooth-Star® Labels (3-pack) – MADFCSSTICKPK15

Pulse® Labels (3-pack) – MADPLSSTICKPK15

Net Price Each*: \$4.00



Display labels for doors and clings for glass shown on example display (not included).

Display Clings for Glass

A set of three (3) clings designed to stick to glass lites call out the features and benefits of display doors, glass or components. Place one (1) per door at the bottom of a 1/2-lite to achieve the best look.

Net Price Each*: \$10.00



Classic-Craft. Messaging Clings (3-pack) – MADCCCLING15
24" w x 6" h

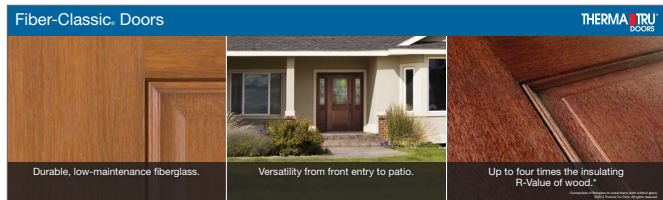
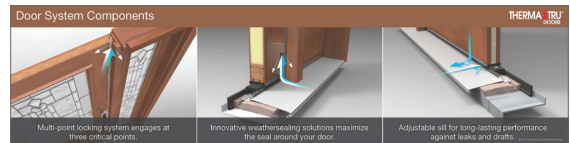
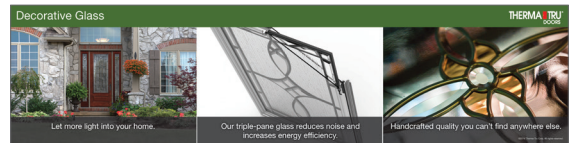

Fiber-Classic. Messaging Clings (3-pack) – MADFCCLING15
20" w x 6" h

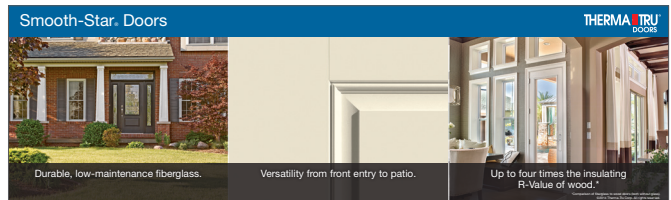
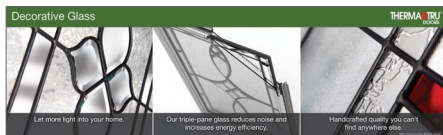

Smooth-Star. Messaging Clings (3-pack) – MADSSCLING15
20" w x 6" h

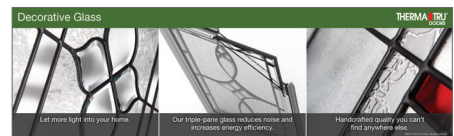
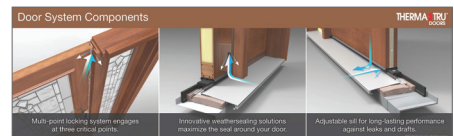

*Pricing subject to change without notice.

Consumers Digest Materials

Promote the fact that *Consumers Digest* has designated the Therma-Tru® Classic-Craft, and Fiber-Classic® lines of entry doors as Best Buy selections.

Visit www.classiccraftconsumersdigest.com to order Therma-Tru *Consumers Digest* promotional materials for your showroom free of charge.

Available:

- Label
- Flyer
- Guidelines



Therma-Tru® Display Labels



Lifetime Limited Warranty Label

MAWLBL14

3" w x 3" h

Removable display label.

Net Price Each*: \$0.45 – 5 STD. PK. QTY.



NEW DoorWays™ App Label

MADWYAPLBL15

3-3/4" w x 3-3/4" h

Removable display label.

Net Price Each*: \$0.40

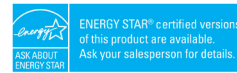

ENERGY STAR® Label

MADENERGYSTAR

3-1/2" w x 1" h

Removable display label.

Net Price Each*: \$0.35 10 STD. PK. QTY.

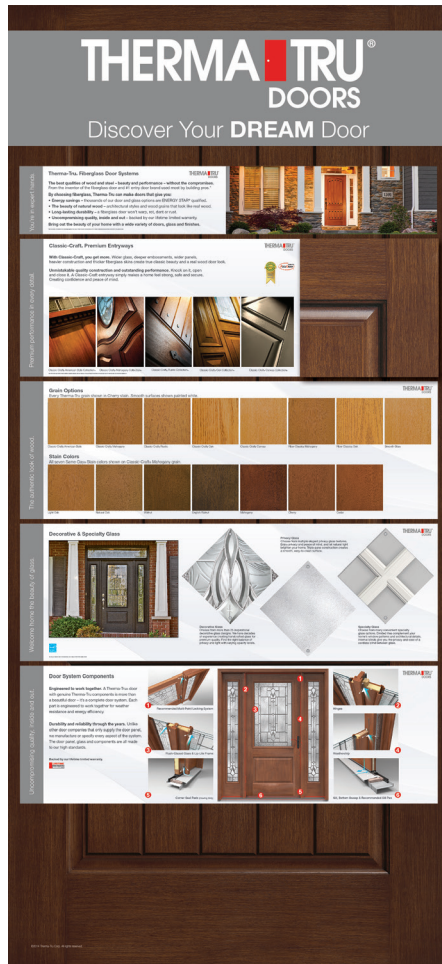

Wall Selection Center

MADWALLSLCNTR15

3'4" w x 7'3-1/2" h

Convenient wall-mounted unit saves space, featuring interchangeable panels with helpful details about doors, glass and components to aid your customers in the selection process.

Net Price Each*: \$875.00

NOW: \$475.00 While Supplies Last!

Unfinished Wall Selection Center

MADWALLSLCNTR15UF

Same as above, but with unfinished stain chips.

Net Price Each*: \$825.00

NOW: \$400.00 While Supplies Last!

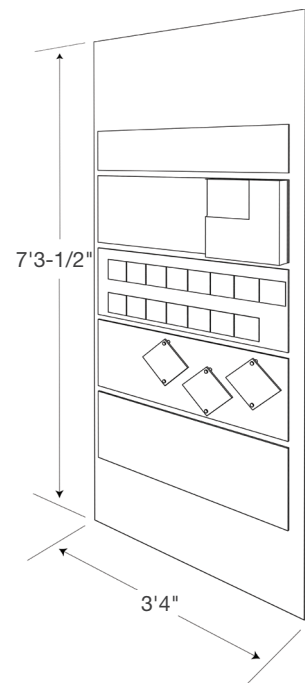

NEW Vinyl Banners



Therma-Tru. 13 oz. Vinyl Banner

MALT TB

6'0"w x 3'0"h

Banner with six (6) grommets for indoor / outdoor use.

Net Price Each*: \$50.00



Therma-Tru. 13 oz. Vinyl Banner (Customizable)

MALT TCB

6'0"w x 3'0"h

Banner with six (6) grommets for indoor / outdoor use. Space provided for your four-color company logo and / or copy.

Net Price Each*: \$50.00

Showroom Window Cling



Authorized Therma-Tru. Dealer Window Cling – Double-Sided

MAFT TADD

24"w x 10"h

Net Price Each*: No Charge

Posters

Take advantage of wall space to showcase the beauty of Therma-Tru products in your showroom. These vibrant images are printed on a durable styrene material that's sturdy enough to hang without a frame.

24"w x 36"h

	Description	Part Number	Net Price Each*
A	Decorative Glass Collection	MADPOSTDG16	\$20.00
B	Classic-Craft. Premium Entryways	MADPOSTCC16	\$20.00
C	Fiber-Classic. Collections	MADPOSTFC16	\$20.00
D	NEW Smooth-Star.	MADPOSTSS17	\$20.00
E	NEW Pulse.	MADPOSTPLS17	\$20.00
F	Door System Components	MADPOSTSYST15	\$20.00
G	NEW Impact	MADPOSTIMPACT17	\$20.00
H	NEW A Complete Door System	MADPOSTTWT17	\$20.00
I	NEW Door Construction	MADPOSTDC17	\$20.00

*Pricing subject to change without notice.

A



DREAM
Decorative Glass
Collection

Welcome home the beauty of glass. Entryways come to life with beauty and craftsmanship you can't find anywhere else.



THERMA TRU DOORS

B



INSPIRE
Classic-Craft
Premium Entryways

Extraordinary in every detail. An inspired blend of precision engineering and architectural character.



THERMA TRU DOORS

C



BEAUTY
Fiber-Classic
Collections

Wood grains to suit any style. Extending the look of real wood to the outside with beauty and elegance.



THERMA TRU DOORS

D



STYLE
Smooth-Star

Smooth, paintable surfaces. Ready to paint with crisp, clean contours.



THERMA TRU DOORS

E



SLEEK
Pulse

Make a bold statement. Modern designs to suit Contemporary home styles.



THERMA TRU DOORS

F



QUALITY
Door System
Components

Uncompromising quality, inside and out. Engineered to work together with craftsman precision for durability and reliability.



THERMA TRU DOORS

G



TOUGH
Impact-Rated
Products

Tough when you need it. Beautiful always.



THERMA TRU DOORS

H

A Complete Door System

More than beautiful doors and glass, a complete door system includes the components used to assemble it. We manufacture or specify every aspect of a complete door system. The Therma-Tru genuine components shown here are our premium options for long-lasting durability.



- 1 Composite Adjustable Sills**
Sealing and adjusting composite sill seal against uneven concrete thresholds. Heavy-duty adjustable sill seal to ensure a tight seal over time.
- 2 Dual-Flush / Dual-Fin Weatherstripping**
A dual-flush, dual-fin design helps prevent light leaks and reduces air infiltration.
- 3-Shape Corner Seal Pads (Shoring Only)**
Prevents corner seal pads from pulling out of the hole caused by air from walking up the weatherstripping.
- 4 Removable Weatherstrip**
Resilient design compresses when closed and flexes back when open. Removable for long-lasting sealing power.
- 5 Multi-Point Locking Systems (Customizable)**
Customizable locking system and frame enhance stability and the performance of the door.
- 6 Ball-Bearing Hinges**
Hinges with ball bearings, padding and long pins for superior performance. They rotate for easy opening and closing.
- 7 Frame Components**
Check with your Therma-Tru dealer for options to complete the door system. Including the essential threshold, weatherstripping and sill seal. Therma-Tru offers a wide range of options to suit your needs.

THERMA TRU DOORS

I

Door Construction

Classic-Craft, Premium Entryways

- 1 Enhanced Weather Resistance**
Top and bottom composite sills protect the door.
- 2 Solid Security**
A 2" full-grain engineered lumber lock stile for added weight and rigidity.
- 3 Excellent Durability**
Fiber-Classic sills provide added durability and better long-term performance.
- 4 Higher R-Values**
Higher R-Value doors provide up to four times the R-value of wood.
- 5 Edge-to-Edge Moisture Protection**
Hardwood and composite edges help prevent moisture penetration.



Fiber-Classic, & Smooth-Star

- 1 Weather Resistance**
Composite sills protect the door at the top and bottom edges.
- 2 Security**
Engineered lock block with 1-1/2" engineered lumber lock stile.
- 3 Durability**
Fiber-Classic fiberglass won't warp or rot. Unlike steel, it won't dent or rust.
- 4 R-Values**
Fiber-Classic sills provide up to four times the R-value of wood.

THERMA TRU DOORS

Door Cutaways

Door cutaways offer a great way to highlight specific high-quality construction attributes of Therma-Tru® doors, such as the sturdy lock stile and seamless flush-glazed look.



Impact Glass / Lip-Lite Frame Sample

MADIG07

6"w x 8"h

Net Price Each*: \$65.00



Smooth-Star. Solid-Panel Impact Door Sample

MADOG07

6"w x 6"h

Net Price Each*: \$40.00



Classic-Craft. Mahogany Door Section with Lock Stile

MASDSMH08

12"w x 12"h

Door section with both sides stained Mahogany.

Net Price Each*: \$25.00



NEW Double-Sided Flush-Glazed Door Section with Clear Glass

MADFCOSSFGCL16-SDL

14"w x 14"h

Door section with Fiber-Classic. Oak stained Natural Oak one side and Smooth-Star. unfinished on the other side.

Net Price Each*: \$125.00



NEW Double-Sided Flush-Glazed Door Section with Privacy & Textured Glass

MADFCOSSFGXN16

14"w x 14"h

Door section with Fiber-Classic. Oak stained Natural Oak one side and Smooth-Star. unfinished on the other side.

Net Price Each*: \$118.00

Countertop Displays



Smooth-Star. Countertop Case *not included.*

MADA200S07

13"w x 13-1/2"h

One side painted White and one side unfinished.

Net Price Each*: \$95.00



Classic-Craft. Mahogany Countertop Case *not included.*

MAD0103CM07

13"w x 13-1/2"h

One side painted Tan and one side stained Cherry.

Net Price Each*: \$150.00



Classic-Craft. Mahogany & Smooth-Star. Countertop Case

MACTRSTB12

17"w x 15"h x 8"d

Messenger-style bag with shoulder strap and handle for ease of transporting samples.

Carrying case only.

Net Price Each*: \$40.00



Multi-Point Locking System

MADMPLS
8" w x 34" h x 5" d
Case not included.
Net Price Each*: \$190.00

Multi-Point Locking System Case

MADMPCS
10" w x 37" h x 10" d
Carrying case only.
Net Price Each*: \$105.00



NEW Side-By-Side Display Carrying Case
MADCCFC15CASE
Carrying case only.
Net Price Each*: \$72.50



Classic-Craft / Fiber-Classic Side-by-Side Display
MADCCFC15

Shows the look and feel, and construction, of Classic-Craft and Fiber-Classic with Mahogany door sections side by side. Can be disconnected quickly to show each door's features independently from the other. Also includes recommended hinges for easy demonstration.
Net Price Each*: \$325.00

Unfinished Classic-Craft / Fiber-Classic Side-by-Side Display

MADCCFC15UF
Includes all pieces and parts to assemble the side-by-side display with unfinished Classic-Craft and Fiber-Classic Mahogany door sections that are ready for you to stain.
Net Price Each*: \$300.00
Optional cover available. Contact your Customer Account Representative for order details.

Fiberglass Skin Sheets

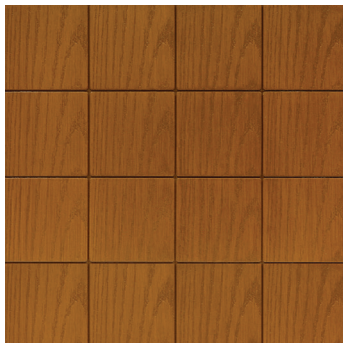

Fiberglass Skin Sheets
Unstained skin sheets can be separated to create individual 4" w x 4" h fiberglass skin samples.
Standard package includes 14 sheets that can be cut to make 224, 4" w x 4" h fiberglass skin samples.
Net Price Each*: \$110.00 per box of 14 sheets

Description	Part Number
Classic-Craft. American Style	MASPSCCAUF-224
Classic-Craft. Mahogany	MASPSCCMUF-224
Classic-Craft. Rustic	MASPSCCRUF-224
Classic-Craft. Oak	MASPSCCOUF-224
Classic-Craft. Canvas	MASPSCCVUF-224
Fiber-Classic. Mahogany	MASPSFCMUF-224
Fiber-Classic. Oak	MASPSFCOUF-224
Smooth-Star.	MASPSSSUF-224

NEW Quarter Doors



	Description (40"w x 17"h)	Stain / Paint	Part Number	Net Price Each*
A	Classic-Craft. American Style	Natural Oak	MAQDCCA17	\$125.00
B	Classic-Craft. Mahogany	Walnut	MAQDCCM17	\$125.00
C	Classic-Craft. Rustic	Cherry	MAQDCCR17	\$125.00
D	Classic-Craft. Oak	Natural Oak	MAQDCCO17	\$125.00
E	Classic-Craft. Canvas	SW 6106 Kilim Beige	MAQDCCV17	\$125.00
F	Fiber-Classic. Mahogany	Cherry	MAQDFCM17	\$90.00
G	Fiber-Classic. Oak	English Walnut	MAQDFCO17	\$90.00
H	Smooth-Star.	SW 7042 Shoji White	MAQDSS17	\$80.00

Note: Also available upon request as unfinished product.

NEW Door Skin Samples



	Description (12"w x 12"h)	Stain / Paint	Part Number	Net Price Each*
A	Classic-Craft. American Style	Natural Oak	MASDSOCCA17	\$18.50
B	Classic-Craft. Mahogany	Walnut	MADSOCM17	\$18.50
C	Classic-Craft. Rustic	Cherry	MASDOCCR17	\$18.50
D	Classic-Craft. Oak	Natural Oak	MASDOCCO17	\$18.50
E	Classic-Craft. Canvas	SW 6106 Kilim Beige	MASDSOCCV17	\$18.50
F	Fiber-Classic. Mahogany	Cherry	MASDSOFM17	\$16.50
G	Fiber-Classic. Oak	English Walnut	MASDSOFCO17	\$16.50
H	Smooth-Star.	SW 7042 Shoji White	MASDSOSS17	\$16.00

Note: Also available upon request as unfinished product.

*Pricing subject to change without notice.

D2D (Door to Door) Travel Bag



MADTTSTB11

12"w x 13"h x 5"d

Messenger-style bag with shoulder strap and handle. Includes:

- Decorative & Specialty Glass Collection Brochure.
- Finished 12"w x 12"h Classic-Craft® Mahogany door section.
- Finished 12"w x 12"h door skin samples in Classic-Craft American Style, Classic-Craft Rustic, Classic-Craft Oak, Fiber-Classic Mahogany, Fiber-Classic Oak and Smooth Star.
- Extra compartment for other sales tools.

Net Price Each*: \$195.00

Unfinished D2D Travel Bag

MADTTUFSTB11

Same as above but with unfinished 12"w x 12"h door samples.

Net Price Each*: \$170.00

NEW System Storyboard



MADSTRYBD16

9-1/2"w x 20-1/2"h x 5-1/2"d

There's a story behind every door. Show homeowners the value of a Therma-Tru® door system. The System Storyboard makes it easy to demonstrate features and benefits with product samples and visual aids.

Net Price Each*: \$200.00

NEW Glass Sample Case

MASGC17

8"w x 9-1/4"h

Case has all field glass samples in 3" w x 3" h size.

Net Price Each*: \$190.00



Component Samples



Grilles Between Glass (GBGs) Sample Chain

MADGBGS14

Represent the grille options in coordination with pre-finished color options and door availability.

Net Price Each*: \$20.00



Simulated Divided Lites (SDLs) Sample Chain

MADSCLS14

Represent the divided lite options in coordination with Same-Day® Stain color options and door availability.

Net Price Each*: \$20.00

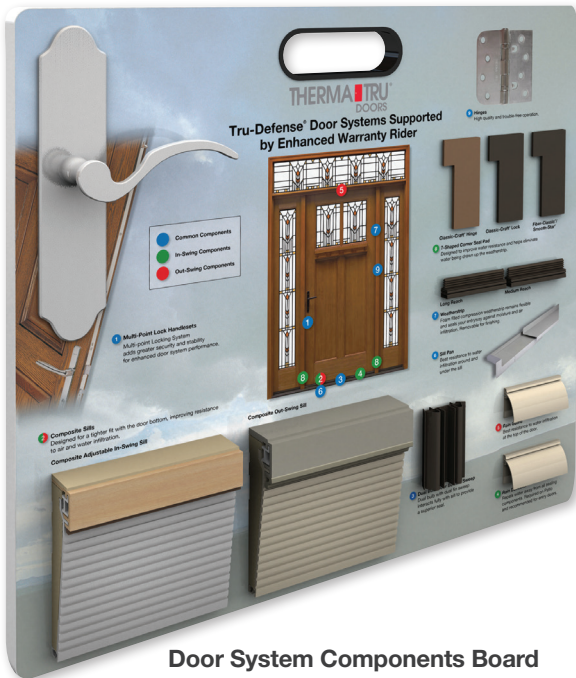

Door System Components Board

MADTDB11

24"w x 21"h

Handheld board includes actual components:

- Inswing composite sill.
- Dual-bulb / dual-fin bottom sweep.
- Rain deflector.
- Medium-and long-reach side weatherstrip.
- Outswing composite sill.
- Classic-Craft. lock and hinge side corner seal pads.
- Fiber-Classic. / Smooth-Star. corner seal pads.
- Rain guard.
- Handleset.

Net Price Each*: \$205.00



Hinge Board

MADHSB08

11-3/4"w x 23-3/4"h

Handheld board that includes nine (9) mounted half hinges to represent hardware finish options:

- Polished chrome.
- Stainless steel.
- Brushed nickel.
- Zinc dichromate.
- Antique nickel.
- Bright brass.
- Oil-rubbed bronze.
- Antique brass.
- Black nickel.

Net Price Each*: \$70.00



Security Strike Plate Comparison Sample

MADSSPC10

7"w x 4"h clear acrylic.

Net Price Each*: \$30.00

*Pricing subject to change without notice.

Stain Samples



Classic-Craft. Fan Deck

MADCCFAN14

Classic-Craft printed fan deck to compare different Same-Day® Stain colors for the chosen grain.

Net Price Each*: \$30.00



Fiber-Classic. Mahogany Stain Chart

MASFCM707

10-1/2" w x 24-1/2" h

Chart featuring medium shades of all seven (7) Same-Day Stain colors.

Net Price Each*: \$35.00

Fiber-Classic. Oak Stain Chart

MASFC707

10-1/2" w x 24-1/2" h

Chart featuring medium shades of all seven (7) Same-Day Stain colors.

Net Price Each*: \$35.00

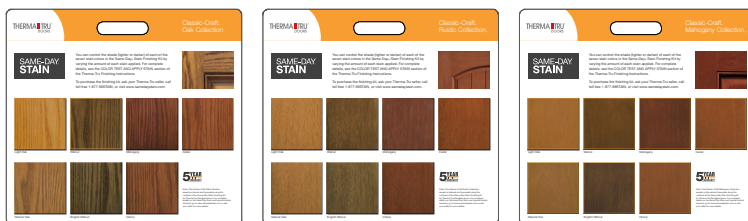
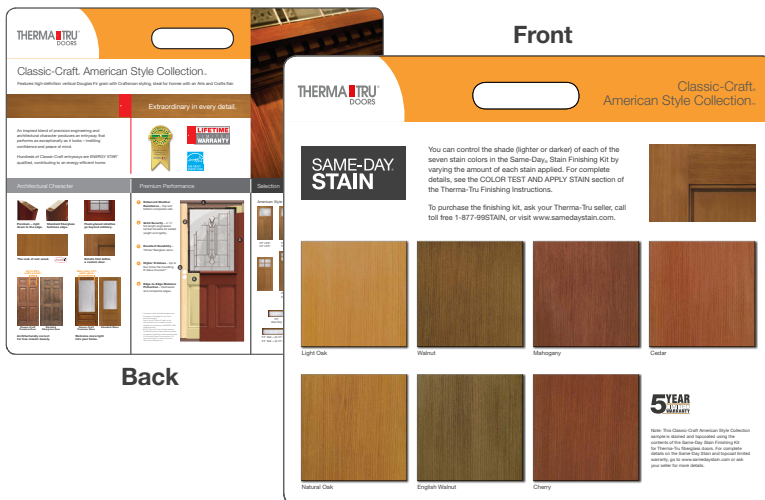

Classic-Craft. Stain Hand Sample Boards

18-1/2" w x 17" h

Boards for each of the four (4) wood-grained Classic-Craft collections feature product details and medium shades of Same-Day Stain in all seven (7) colors on 4" x 4" fiberglass chips. Protective cover included. Also available unstained.

Finished

Classic-Craft. American Style – MASCCA15

Classic-Craft. Rustic – MASCCR15

Classic-Craft. Mahogany – MASCCM15

Classic-Craft. Oak – MASCCO15

Net Price Each*: \$70.00

Unfinished Kits

Each kit contains 30 boards, 14 unfinished skin sheets and adhesive.

Classic-Craft. American Style Kit – MASCCA15UF

Classic-Craft. Rustic Kit – MASCCR15UF

Classic-Craft. Mahogany Kit – MASCCM15UF

Classic-Craft. Oak Kit – MASCCO15UF

Net Price Each*: \$1,550.00

Literature

In our literature, you can find all the details, features and benefits for all door, sidelite and transom options and accessories. And your customers can find inspiration to enhance their homes with Therma-Tru.



2017 Full-Line Catalog – The Building Professionals' Entry & Patio Door Directory

NEW MAFL2017

Created specifically for trade professionals, this directory serves as a complete and easy-to-use guide with all the information needed to help specify and sell Therma-Tru® products.

Net Price Each*: \$1.45
20 STD. PK. QTY.



Pulse Brochure

NEW MAFULSEB17

Designed to inspire trade professionals to make a bold statement with a contemporary studio of door styles and glass designs that transform the entrance into modern art.

Net Price Each*: \$0.30
50 STD. PK. QTY.



Classic-Craft Premium Entryways Brochure

MAFCCB16

Let your customers experience the difference of a Classic-Craft entryway with its inspired blend of precision engineering and architectural character.

Net Price Each*: \$0.40
50 STD. PK. QTY.

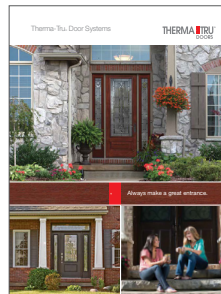

Therma-Tru Door Systems Brochure

MAFWTT09

Explains the reasons why customers should choose Therma-Tru.

Net Price Each*: \$0.50
50 STD. PK. QTY.

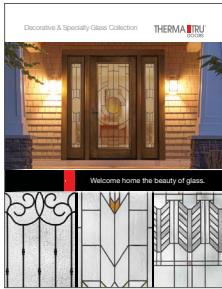

Decorative & Specialty Glass Collection Brochure

NEW MAFGLASS17

Show your customers how Therma-Tru glass makes entryways come to life with beauty and craftsmanship you can't find anywhere else.

Net Price Each*: \$0.80
50 STD. PK. QTY.



New Product Flyers (Set of 3)

NEW MAFTF17

Explains the features and benefits of Therma-Tru's new-for-2017 products: Smooth-Star® Shaker-Style Doors & Sidelites, Flat 3-½" Wide Simulated Divided Lites and 47" Internal Blinds.

Net Price Each*: \$1.25
1 STD. PK. QTY.



Door System Components Brochure

MAFCOMP15

Inspire confidence in a Therma-Tru door system made with genuine Therma-Tru components, engineered to work together and backed by our warranty.

Net Price Each*: \$0.50
50 STD. PK. QTY.



Fiberglass & Wood Door Comparison Brochure

NEW MAFCOMPARISON17

Educate your customers on the similarities and differences of fiberglass and wood – and offer them the best of both worlds with our Classic-Craft premium entryways.

Net Price Each*: \$0.40
50 STD. PK. QTY.



Experience the Difference – Sales Pitchbook

MASPP15

Empower your sales team to close more effectively by knowledgeably discussing the benefits of Therma-Tru premium products. Spiral bound and fits in a pocket.

Net Price Each*: \$3.70
1 STD. PK. QTY.



NEW Flush-Glazed Doors Brochure

MAFFGB17

Show the advantages of Therma-Tru's flush-glazed doors to create a clean look with a wider daylight opening.

Net Price Each*: \$0.35
50 STD. PK. QTY



Therma-Tru Folder

MAFF10

A great way to bundle Therma-Tru literature. It even has a place for your business card!

Net Price Each*: \$0.70
1 STD. PK. QTY.



Curb Appeal Brochure

MAFCAB16

Get inspired and find out how a new Therma-Tru entry door can increase the perceived home value.

Net Price Each*: \$0.20



NEW Architectural Home Styles Guide

MAFAHSG17

Get inspired to choose Therma-Tru entry doors by design with our guide to popular home styles.

Net Price Each*: \$0.55
50 STD. PK. QTY



Tru-Defense Warranty Rider (in Poly Bag)

MAFTDR14

Outlines complete benefits, as well as details and steps necessary to qualify customers for the Tru-Defense Warranty Rider.

Net Price Each*: \$0.45
1 STD. PK. QTY.



Same-Day Stain Finishing Instructions

MAFSI13

Net Price Each*: \$0.25
50 STD. PK. QTY.



NEW 3'6" Entry Door Solutions Brochure

MAFTSEDS17

Give an overview of Therma-Tru's 3'6" wide entry door options perfect for homes with grand entrances.

Net Price Each*: \$0.25
50 STD. PK. QTY.

Model Home Program

View and download Therma-Tru Model Home Program information and claim form on the Customer Portal.

Custom Marketing Program

Create marketing pieces tailored to your business through our Custom Marketing Program. Brochures, yard signs, door hangers, direct mail postcards and mail stuffers are available to customize with your own message – helping you differentiate your business and reach potential customers in your market.

Templates

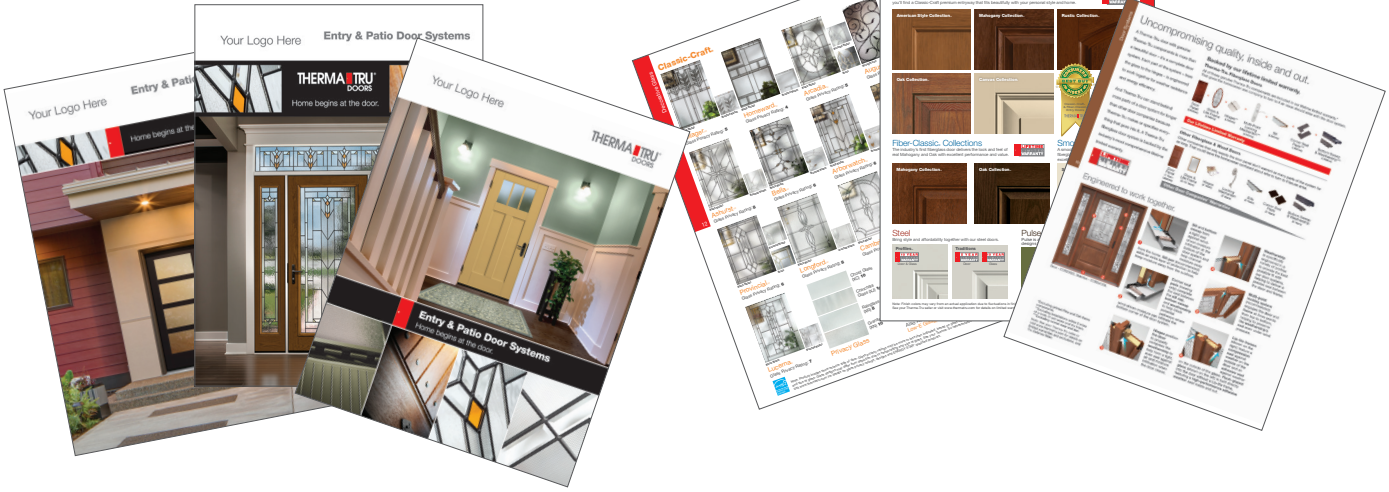

Custom Literature

Custom literature is an industry-proven tool that showcases your business and the Therma-Tru products you sell.

- Choose from a variety of customizable templates.
- Select products for your business.
- Create messaging designed to tell the story of your business.
- Accessorize the entry – include the Fypon® door surround product template page.
- Show what a difference a stylish new Therma-Tru door makes and help bring out the best of the home's style with the Curb Appeal and Architectural Home Styles Guide template pages.

Feature Products By:

Glass Design

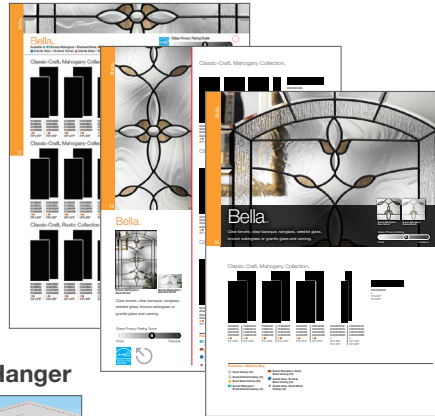

Door Selection

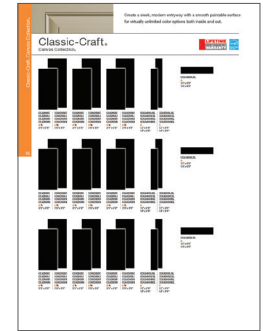

Yard Sign



Door Hanger

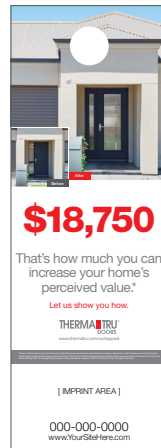

Postcard



Mail Stuffer



Yard Signs, Door Hangers, Postcards & Mail Stuffers

Target customers with your message.

- Increase visibility and referrals with a customized yard sign for your job sites.
- Communicate your brand door-to-door with door hangers.
- Customize a direct mail program with postcards and mail stuffers.

*Pricing subject to change without notice.

For program details and pricing, visit www.thermatru.com/trade/custom-marketing.

Installation Instructions

Easy-to-follow, step-by-step instructions are available to make the installation of any Therma-Tru® door straightforward and successful.

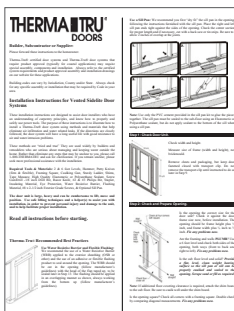
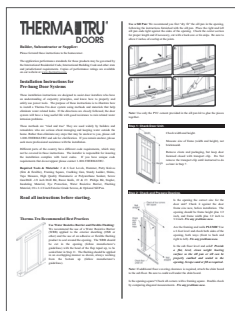

Bilingual Installation Instructions

MSDRIST65

Entry and Patio Doors (English and Spanish)

Net Price Each*: No Charge
1,000 STD. PK. QTY.

Bilingual Installation Instructions

MSDRIST-VS

Entry and Patio Doors with Vented Sidelites (English and Spanish)

Net Price Each*: No Charge
250 STD. PK. QTY.

To download installation instructions, please visit www.thermatru.com/customer-support/installation-instructions.

Training Aids

To help you effectively sell and install Therma-Tru products, these training tools have everything you need to measure and prepare openings, install a door and maintain the exceptional look of a Therma-Tru door.



Installation Video

MA3VID14

Following segments all on one (1) DVD:

- Installation (New Construction & Remodeling)
- Troubleshooting
- Same-Day, Stain Finishing

Total Length: 142 minutes

Net Price Each*: \$4.00

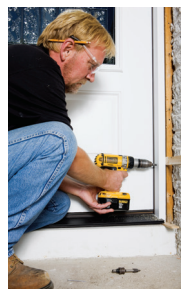

Core Installation Training Folder

MADCOREINSTALL

Folder includes everything you need to learn about proper exterior door installation, including step-by-step DVD.

Net Price Each*: \$8.00
1 STD. PK. QTY.

NEW Unit Dimension Tape Measures



Book Size: MADUDTPMSRBK16

U1 Revised Size: MADUDTPMSRU1R16

Take the guesswork out of measuring openings from 2'0" single doors to 9'0" triple doors – and everything between. This tape measure features unit dimension widths and heights to help simplify the door measuring process.

Net Price Each*: \$5.50

Warranty Documents

You can provide your customers with warranty documents that will help them appreciate how Therma-Tru will stand behind their purchase, offering them peace of mind in their choice for a new door system. These documents are available for you to download at www.thermatru.com.

Fiberglass & Steel Entry & Patio Door System Warranty

Tru-Defense® Fiberglass Door Systems Rider

Same-Day® Stain Warranty

Vinyl Sliding Patio Door System Warranty

Flush-Glazed Fiberglass Door Replacement Rider

NEW Technical Manuals

Technical documentation provides you with the tools that help you do your job and know all the ins and outs of your Therma-Tru® products. These documents are also available for you to download at www.thermatru.com.

Door Styles Manual

Book: MAEDSTYLE17BOOK
 U1 Revised: MAEDSTYLE17U1REV
 Hybrid: MAEDSTYLE17U4
 Net Price Each*: \$35.00

Architectural Details & Components

Book: MAEDCOMP17BOOK
 U1 Revised: MAEDCOMP17U1REV
 Hybrid: MAEDCOMP17U4
 Net Price Each*: \$22.50

Site Manual

MAED17SITE
 Net Price Each*: \$10.00

Shop Manual

Book: MAEDSHOP17BOOK
 U1 Revised: MAEDSHOP17U1REV
 Hybrid: MAEDSHOP17U4
 Net Price Each*: \$25.00

Unit Rough Opening Sizing Booklet

Book: MAEDCOMPDD17BOOK
 U1 Revised: MAEDCOMPDD17U1REV
 Hybrid: MAEDCOMPDD17U4
 Net Price Each*: \$1.50

NEW Sell Sheet & Door Signage Templates

Create professional PowerPoint sell sheets and display door signage supporting your business with your company information – it's quick and easy. Simply go to www.thermatru.com/builder to view:

Instructions

PowerPoint Tools

Templates

Example

Door Signage Templates

Your Logo Here

Headline / Classic-Craft, Door Collection

Glass Name Door Style #

IFP Door IFP Door

Beautiful Low Maintenance

Energy Efficient Durable

\$339⁰⁰

→

Your Logo Here

Fiber-Classic, Mahogany Collection

Blackstone FCB188 Fiber-Classic, Mahogany Collection

Beautiful Low Maintenance

Energy Efficient Durable

\$339⁰⁰

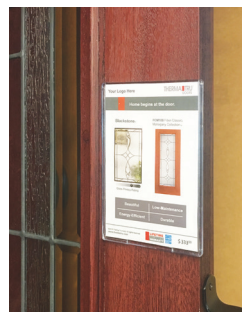

4" x 6" Door Signage Holder

MAD4X6SIGNHLDR

Showcase your custom designed 4" x 6" display door signage with this sign holder. Add on one or both sides of the display door. Each sign holder comes with two (2) strips of double-sided tape.

Net Price Each*: \$2.25

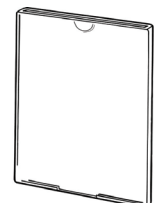

Company Store

To see all the Therma-Tru. branded wearables, event handouts and leave-behinds, visit the company store at <http://thermatru.corpgear.com>. Large quantity quotes available upon request. Minimum order quantities may apply.

Watch for new offerings in the full company store at thermatru.corpgear.com.



Red Door Stress Reliever

The red door says it all! This is a great event giveaway or client leave behind.

Net Price Each*: \$1.55



Pro Locking Tape Measure

25' retractable metal tape (standard and metric) with lock button, wrist strap and metal belt clip.

Net Price Each*: \$5.00



Tablet Case

11-1/2" h x 7-3/4" w x 3/4" d Sleeve with waffle-style interior, stand bar and stylus port offers stylish and functional protection.

Net Price Each*: \$20.00



Carpenter Pencil

Traditional red carpenter pencil. Great for any job site or giveaway.

Net Price Each*: \$0.38



Double Trouble Pen Highlighter

Twist-action ballpoint pen and highlighter with removable cap.

Net Price Each*: \$0.75



Stainless Steel Tumbler

Twist-on, thumb-slide lid. Foam-insulated, double-wall tumbler with plastic lid.

Net Price Each*: \$4.95



Black 6-Pack Insulated Cooler Bag

Foam-insulated and water-resistant PEVA lining. Double zipper closure with Therma-Tru logo in white.

Net Price Each*: \$4.00



Black Cap

Low-profile cap with contrasting sandwich visor. 100% flat cotton twill.

Net Price Each*: \$5.00



Collapsible Can Coozie

Easily holds and insulates 12 oz. cans and folds flat for storage.

Net Price Each*: \$0.65



Adhesive 3" x 3" Notepad

25 Sheets

Net Price Each*: \$0.30



SPECIAL ORDER Pima Sport Shirt

This shirt keeps you cool and comfortable with moisture-wicking PimaCool technology. Colors: Oatmeal Beige, White, Khaki, Navy Blue, Black. Also available in ladies coordinate.

Net Price Each*: \$32.50



T-Shirt

100% cotton gray T-shirt.

Net Price Each*: \$5.75



Polo Shirt

Classic black polo shirt with Therma-Tru logo embroidered on left chest. Also available in khaki and navy for special order.

Net Price Each*: \$20.50

*Pricing subject to change. Tax and freight not included.

Trade Professionals Online

Go to one place to find everything Therma-Tru from selling tools to training materials to technical information. Access to all of this and more is waiting for you.

- Dealer** – www.thermatru.com/dealer
- Builder** – www.thermatru.com/builder
- Remodeler** – www.thermatru.com/remodeler
- Architect** – www.thermatru.com/architect

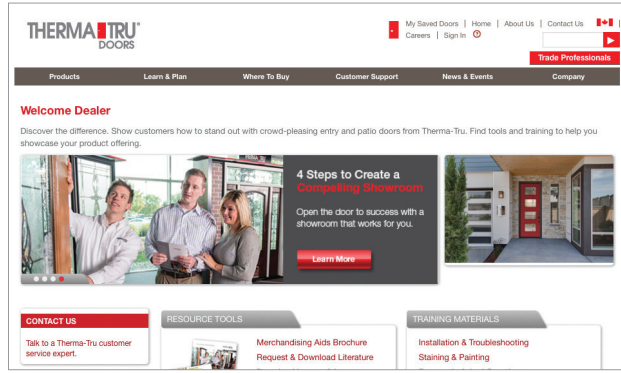

NEW Therma-Tru's Digital Vault

This is your source for Therma-Tru logos, images, literature and more. The Digital Vault gives you access to the materials and tools you use most when selling Therma-Tru products.

Create an account today at www.thermatru.com/digital-vault.

Now Available on the Digital Vault!

2017 Ad Planner

Generate action with advertising tools to help you sell Therma-Tru doors. The Ad Planner includes the following ready-to-use creative elements with space to add your company logo. Promotional funds may be available. See your Therma-Tru seller for details.

- Print Advertising
- Television Advertising
- Radio Advertising
- Outdoor Advertising
- Yellow Pages Advertising
- On-Hold Messaging
- Truck Graphic
- Web Banners
- Product Promotion Templates



Web Banners



Full-Page Print Ads



1/2-Page Print Ads

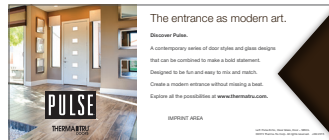

1/3-Page Print Ads



NEW Architectural Home Styles Guide

The power of curb appeal captures attention. And it starts with a stylish front entry door from Therma-Tru. Get inspired to choose entry doors by design with our interactive guide to popular home styles.

www.homestyles.thermatru.com

Visualization Tools

Give customers a preview of what the entrance to their home could look like. Therma-Tru offers a variety of tools to make the visualization process easy for you and your customers.

DoorWays™ App

The power to create the perfect entrance is at your fingertips – it's easier than ever for homeowners to design an entrance and visualize it on their home.

www.thermatru.com/doorways

1. Create and experiment with multiple door and glass combinations in the gallery.
2. Take a picture of the home and pop in the doors they designed.
3. Once they find their perfect new entry, locate their dealer to help them buy it.

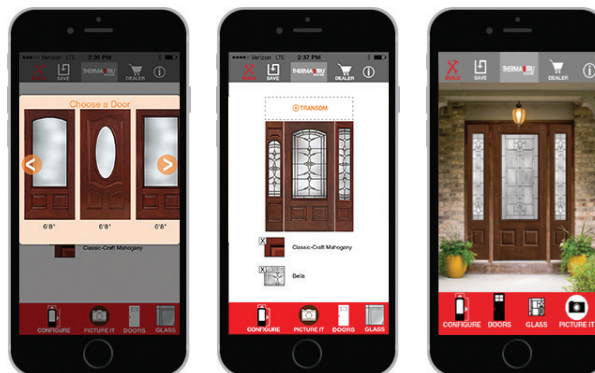

Design Your Door

Make it easier to shop for entry doors. Let homeowners research and design a door with their own personal touch – all from the convenience of home – then email you for an estimate.

www.thermatru.com/products

NEW Dealer Microsite Landing Pages

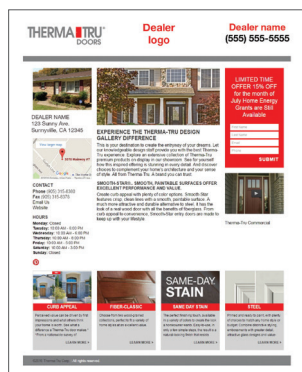

Increase your local online visibility with a Therma-Tru® dealer microsite landing page. This co-branded site connects our website with yours and can help more qualified leads find you online. Ask your Therma-Tru Sales Representative for details.

NEW EasySpec™ Drawing Tools

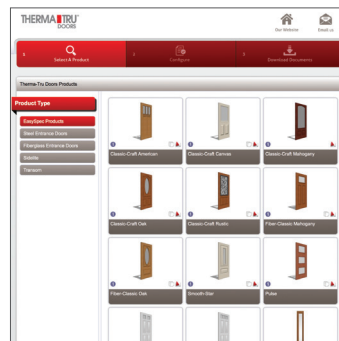

Everything architects and dealers need to specify Therma-Tru doors in one place, including 2D CAD drawings available in multiple file types and product information with 3-part specification documents.

www.thermatru.com/architect

Unlock the Opportunities



Learn about our new products and door system solutions, and enter for a chance to win prizes.



www.unlocktheopportunities.com

Education Center

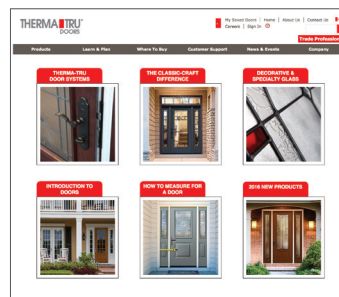

Learn from the experts in fiberglass doors and test your door IQ on a variety of topics.

www.thermatru.com/learning

THERMA-TRU® DOORS

www.thermatru.com

1-800-THERMA-TRU (843-7628)

1750 Indian Wood Circle

Maumee, OH 43537



For a digital copy of this brochure, visit
www.thermatru.com/merchandising.



©2016 Therma-Tru Corp. All rights reserved. THERMA-TRU and the Therma-Tru Logo are trademarks of Therma-Tru Corp. Registered trademarks are registered in the U.S. and may be registered internationally. Therma-Tru Corp. is an operating company of Fortune Brands Home & Security, Inc. All trademarks are property of their respective owners. The Best Buy Seal and other licensed materials are registered certification marks and trademarks of Consumers Digest Communications, LLC, used under license. For award information, visit ConsumersDigest.com. ENERGY STAR is a government program that helps consumers protect the environment through superior energy efficiency and is a registered trademark of the U.S. Department of Energy and the U.S. Environmental Protection Agency. Apple and the Apple logo are trademarks of Apple Inc., registered in the U.S. and other countries. App Store is a service mark of Apple Inc., registered in the U.S. and other countries. Google Play and the Google Play logo are trademarks of Google Inc. Part #MADPMB17 MTZT / DEC 2016