

**Therma-Tru Positive Pressure
(NFPA-252/UL-10C/CAN4-S104)
Labeled Systems**

This Therma-Tru door system has been labeled in compliance with NFPA-252/UL-10C/CAN4-S104 Positive Pressure Smoke and Draft control rating and requires a listed Category "H" gasket and the application of an additional Category "G" edge sealing system included in the Field Pack. To maintain the validity of this certification, the door installer must follow these instructions. They should be kept on file on the building premises for verification by the authority having jurisdiction.

- Verify that the frame is compatible with the door and properly installed.
- Install hardware per the hardware manufacturer's instructions.
- For smoke rating, a listed and labeled category "H" Smoke and Draft control gasket (included) shall be installed to the opening.
- Installation must comply with requirements of NFPA 80 "Standard for Fire Doors and Fire Windows"
- Surface mounted hardware must be attached with through bolts unless interior reinforcement is provided.
- Doors shall be installed in a kerfed adjustable steel frame having 18-gauge base frame with a minimum 22-gauge closure.



1750 Indian Wood Circle Maumee, Ohio 43537
1-800-THERMA-TRU (843-7628)
www.thermatru.com

**Adjusta-Fit® 2
Parts List and Description**

JOB SITE COMPONENTS

TRIM (3 Pieces)

Hinge, Lock and Head Trim



SILL EXTENDER

(included in inswing package only)

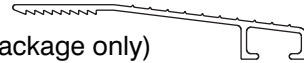

PASSAGE LOCK STRIKE PLATE

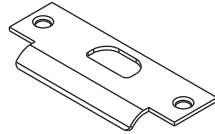

DEADBOLT LOCK PLATE

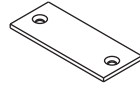

DEADBOLT COVER PLATE (door)

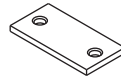

(2) DEADBOLT FILLER (door)

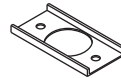

HARDWARE

(2) #8-32 x 3/8" Phillips Undercut Flat Head Type F Self-tapping Machine Screw



(2) #12-24 x 3/4" Phillips Undercut Flat Head Type A Machine Screw

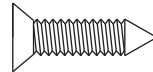

(2) #8 x 3/4" Phillips Flat Head Wood Screw

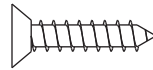

(2) #8 x 1 1/4" Phillips Flat Head Wood Screw

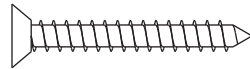

(6) #10 x 2 1/2" Phillips Flat Head Wood Screw

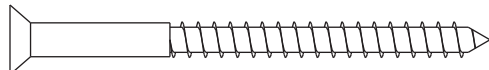

(2) CORNER SEAL PAD

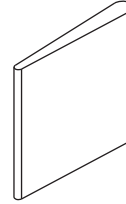

CATEGORY "G" EDGE SEAL

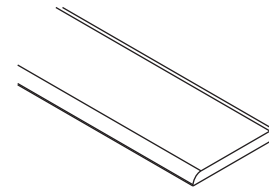

INSTALLATION INSTRUCTIONS

TOOLS REQUIRED

- Drill with Phillips Driver Bit
- Shims
- Caulk Gun and Caulk
- Utility knife or Scissors

PURCHASED SEPARATELY

- Face attachment screws
- #8 x 1 1/4" flat head masonry screws for masonry installations

PAINTING FRAME AND DOOR

- DOOR PREP: Brush or sponge off dirt. Wipe dry.
- FRAME PREP: Wet-clean with mild abrasive cleaner. Rinse completely and wipe dry.
- Paint the door in an open position.
- Use a high quality exterior house paint to finish the frame and door when the temperature is above 50°F and humidity is below 90%.
- DO NOT paint weatherstrip. (It can be temporarily removed for painting.)
- DO NOT close door until the paint is completely dry.

For information on where to purchase Therma-Tru entry door systems, call 1-800-THERMA-TRU (843-7628) or visit www.thermatru.com



**Site
Installation
Instructions
for
Adjusta-Fit® 2**

Read *all* instructions carefully before installing your new Therma-Tru Adjusta-Fit 2 system.

Please note there are separate "Prehanging Instructions" to be reviewed and followed prior to completing the installation.

CODES

Building codes may vary from area to area. If a fire rating is required of the door and opening being framed, the installer must use installation materials and methods to satisfy the authority having jurisdiction. Therma-Tru provides labeled products, but bears no responsibility for installation.

1 CHECK ROUGH OPENING SIZE.

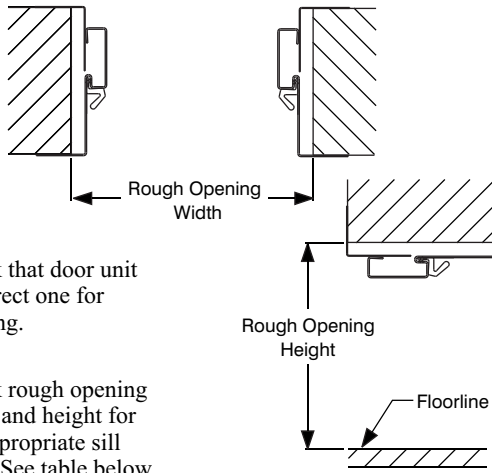

Check that door unit is correct one for opening.

Check rough opening width and height for the appropriate sill type. See table below.

If additional carpet clearance is required, the necessary full shim under the sill will change the rough opening height accordingly.

Sill Type	Rough Opening Height	
	6/8	7/0
Inswing	81 1/4"	85 1/4"
Public Access	80 5/8"	84 5/8"
No Sill	80 1/8"	84 1/8"

Rough Opening Width	
Door	Opening
2/0	25"
2/4	29"
2/6	31"
2/8	33"
2/10	35"
3/0	37"
3/6	43"

2 CHECK ROUGH OPENING FOR ACCURACY.

WARNING: It is critical for proper fit and operation that the rough opening is correct

- Is subfloor level?
- Are walls plumb with jambs?
- Are studs or door bucks plumb?

3 UNITS WITH PUBLIC ACCESS SILLS, CAULK BOTTOM OF SILL

For public access sills, apply caulk along entire length of sill as shown.

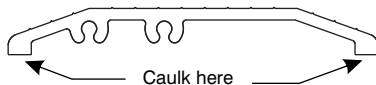

4 CENTER UNIT IN OPENING AND FASTEN FLANGES TO WALL.

Place unit on correct side of opening. Do not remove "L" bracket until door is in place, plumb and shimmed. Center unit in rough opening and set flanges flush and plumb against wall. Nail or screw flanges to wall through punched holes at perimeter.

For jambs exposed to weather: caulk entire perimeter on underneath side of nailing flange.

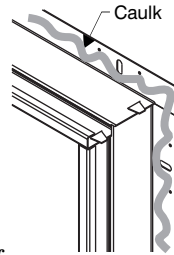

5 LOCATE AND SECURE SHIMS BETWEEN WALL AND FRAME.

Keeping door closed, carefully shim between wall and frame. Shim hinge jamb behind hinges and the lock jamb as indicated in the figure below to plumb and level the door. Remove "L" bracket from door.

DO NOT allow shim force to twist frame. Insufficient shimming could cause jamb to bow at lock area allowing door to come open during a fire.

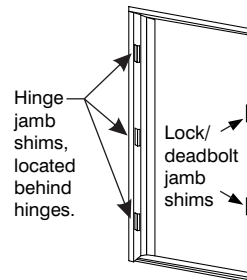

6 DRIVE SECURITY SCREWS INTO HINGE LEAVES.

With door open, at hinges where indicated, drill 7/64" diameter pilot holes and fasten #10 x 2 1/2" screws (provided) through holes in each hinge leaf.

(6) #10 x 2 1/2" screws

(Contact your local Therma-Tru distributor for alternate screw finishes.)

7 FASTEN LOCK JAMB TO WALL

Close the door and finish securing the face of the frame in the remaining holes.

8 FASTEN LOCK PLATES TO LOCK JAMB

Fasten strike plate with (2) #12-24 x 3/4" Phillips flat head Type A machine screws and deadbolt plate with (2) #8-32 x 3/8" Phillips flat head Type F self-tapping machine screws provided.

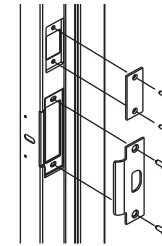

9 CAULK ALONG FRONT OF SILL BASE.

Prior to installing extender, apply a bead of caulk along front leg of riser.

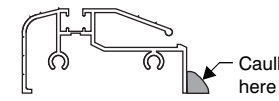

10 INSERT EXTENDER INTO RISER.

Caulk feet of extender before sliding into base. Slide extender into sill base until it comes in contact with jamb stop.

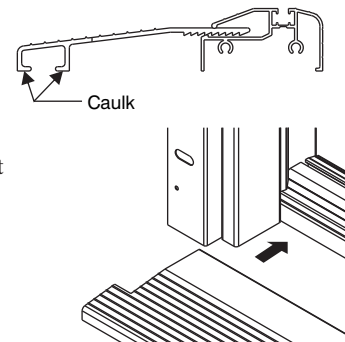

11 SLIDE TRIM ONTO JAMBS.

NOTE: If insulation is required between the frame and rough opening, insulate before sliding trim onto jamb.

Slide hinge and lock trim on first. Be sure that trim ends are resting on the sill or floor. Next apply head trim. Fasten to wall with nails or screws at hole locations.

For trim exposed to weather: caulk entire perimeter on underneath side of nailing flange. (refer to step 4 for illustration)

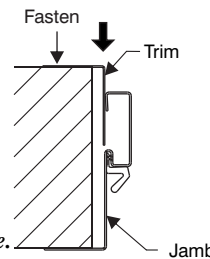

12 CAULK UNITS EXPOSED TO WEATHER.

Apply a bead of caulk at jamb/sill, trim/sill, jamb/trim and sill/floor joints.

Remove paper backing from self-adhesive corner seal pads and apply to jambs with the wide side pointing towards the weather-strip and bottom edge resting on the sill.

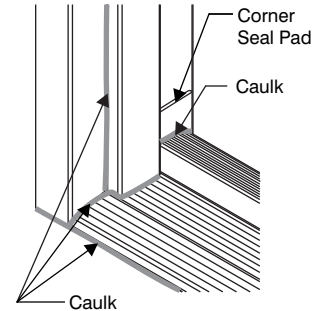

13 ANCHOR SILL TO FLOOR

Using #8 x 1 1/4" screws, provided, for wood frame installation, fasten aluminum extender to floor thru pre-punched holes.

When installing into masonry openings, use #8 flat head masonry screws following screw manufacturer's instructions.

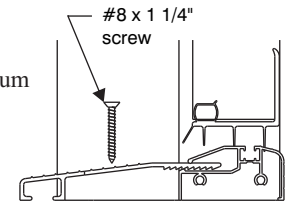

14 PAINT

See "PAINTING FRAME AND DOOR" on other side.

15 APPLY CATEGORY "G" EDGE SEAL

Cut head edge seal to fit between side jambs. Apply to head jamb locating it under and against weatherstrip. Measure and cut side edge seal to fit between head and sill. Cut to fit between hinges and strikes. Locate and apply to jambs as shown.

