

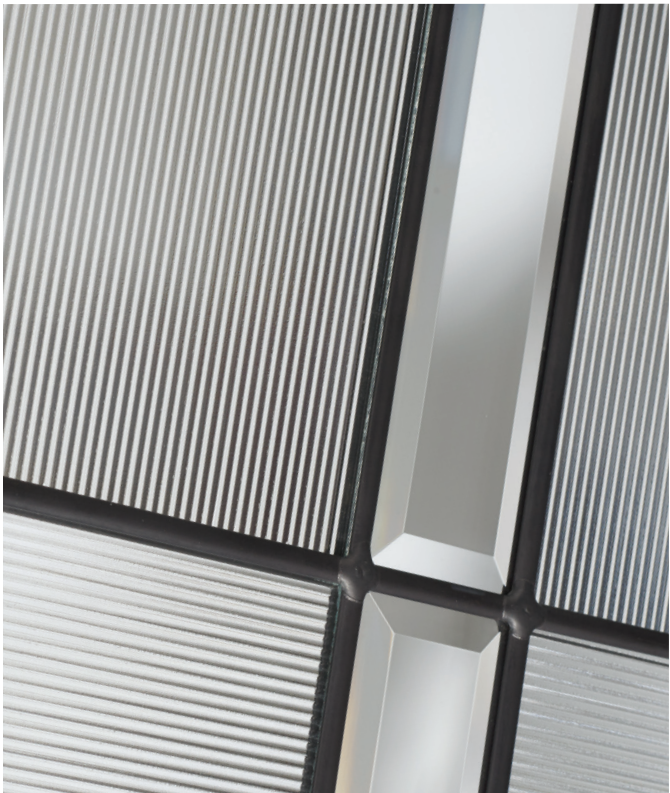

Welcome to Therma-Tru.





• Welcome to Therma-Tru.

Congratulations on  
the purchase of  
your new  
Therma-Tru® door!

Welcome to Therma-Tru, the most preferred brand of entry doors chosen by builders and remodelers.

With proper care and maintenance, your Therma-Tru door will bring years of care-free performance and enduring beauty.

This manual provides valuable information to help you install, clean and maintain your Therma-Tru door. If you ever have a question about your door, refer to this manual for guidance on troubleshooting, how to order key replacement parts and warranty information.

For additional customer support, please visit [www.thermatru.com](http://www.thermatru.com) or contact us at:  
1-800-843-7628 (1-800-THERMATRU)  
8 a.m.—6 p.m. EST  
Monday—Friday  
Email: [customersupport@thermatru.com](mailto:customersupport@thermatru.com)

# Table of Contents

<b>Warranty Information .....</b>	<b>4-18</b>
Fiberglass & Steel Door Systems .....	4-10
Vinyl Sliding Patio Door Systems .....	11-13
Tru-Defense .....	14-16
Same-Day, Stain .....	17-18
<b>Installation &amp; Finishing Instructions .....</b>	<b>19-24</b>
<b>Care &amp; Maintenance .....</b>	<b>25-26</b>
<b>Troubleshooting Guide .....</b>	<b>27-29</b>
Air and/or Light Leak at Top or Bottom of Jamb .....	27
Water Leakage Around or Under Sill .....	27
Water Leakage Around Door/System Perimeters .....	28
Water Leakage Around Lites .....	28
Water Leakage Around Fiber-Classic, Designline Panels .....	28
Door Will Not Open or Close Properly .....	28
Spring Loaded Hinge Adjustment Instructions .....	29
Classic-Craft® & Smooth-Star® Raised Panels Are Loose .....	29
Internal Blinds Care & Handling .....	29
<b>Common Replacement Parts .....</b>	<b>30-42</b>
Introduction .....	30
Common Replacement Parts Identification .....	31-32
Astragals .....	33-34
Corner Seal Pads .....	35
Door Bottom Sweeps (Gaskets) .....	36
Sill Gasket .....	36
Foot Bolt Kit .....	37
Divided Lites .....	37
Hinges & Screws .....	38-39
Plugs on Frame .....	40
Rain Deflector .....	40
Rain Guard .....	40
Weatherstrip .....	41
Internal Blinds .....	42
Same-Day, Stain .....	42

# Fiberglass & Steel Door Systems

## Therma-Tru® Fiberglass and Steel Door Systems

Fiberglass – Classic-Craft®, Fiber-Classic®, Smooth-Star®, and Pulse™ Door Systems  
 Steel – Pulse™, Profiles™, Traditions, and Therma-Tru® Fire Door (TR 12-24) Steel Edge Door Systems  
 Residential Limited Warranty  
 For Purchases Made on or After January 1, 2014

### 1. WHAT THE LIMITED WARRANTY COVERS AND FOR HOW LONG

#### a) PRODUCT DEFINITION:

THERMA-TRU® DOOR SYSTEM (“Product”) consists of a Therma-Tru fiberglass or steel door slab(s) named above and the following parts when they are genuine Therma-Tru components: sidelites, any applied or inserted panels, dentil shelf, simulated-divided lites on doors and sidelites, glass lite inserts with Therma-Tru logo glass temper blaze, wood grilles, hinges, weatherstrip, door bottom sweep (gaskets), rain deflector, rain guard, sill pan, screens, internal grids, corner seal pads, door sill, astragal, steel door frame, rot-resistant jambs, rot-resistant mullions, rot-resistant brickmould and multi-point locking system door handles and lockset (on fiberglass Products only). This Limited Warranty applies only when all of these parts are genuine Therma-Tru components. Other all-wood parts including primed pine jambs, primed pine mullions, primed pine brickmould, oak jambs, oak mullions, oak brickmould, mull casing, and steel Product’s locking systems are not covered by this Limited Warranty.

#### b) COVERAGE:

Subject to the limitations and exclusions below, and for the duration of the applicable stated Warranty Period, Therma-Tru warrants that Products purchased and installed in the USA or Canada:

**NON-GLASS COMPONENTS:** Are free from non-conformities in material and workmanship. All hinges in fiberglass and steel Product, and multi-point locking systems installed in a fiberglass Product are also warranted against non-conformities in the mechanical and locking mechanism (excluding (i) installations within 5 miles of a body of salt water, (ii) the finish, and (iii) multi-point locking systems installed in steel Products). See Section 2a “WHAT THIS LIMITED WARRANTY DOES NOT COVER” for clarification.

**GLASS COMPONENTS:** Are free from non-conformities in material and workmanship resulting in internal glazing failure, seal failure, internal insert slippage, and permanent and material visual obstruction from moisture or dust film formation in the air space of the sealed glass unit.

#### NOTES ABOUT TIMELY FINISHING OF DOOR SYSTEMS:

- For continued warranty coverage, all fiberglass Therma-Tru door systems (Products) must be finished within 6 months of the installation date; and all steel Therma-Tru door systems (Products) must be finished within several days of the installation date. However, all bare or unprotected wood surfaces (such as door frames) on all steel and fiberglass Products (including any bare or unprotected wood surfaces used or exposed by builders, contractors, dealers or distributors on or in conjunction with the Products) should be primed and painted, or stained and top coated within the lesser of 2 weeks of installation or exposure to weather. All doors must have all 6 sides finished. (Note: If a genuine Therma-Tru door bottom sweep (gasket) is properly applied by the builder, contractor, dealer, or distributor to the bottom edge of the door, then only the 5 remaining sides of the door require finishing.) For all doors, sides, top and bottom must be inspected and maintained as regularly as the front and back face surfaces. All PVC lite frames and simulated-divided lite bars must be finished within 30 days of installation and are not recommended to be painted dark colors.
- Improper or untimely finishing of the Product by the Warranty Holder or its agents (i) increases the chance for Product damage of the type which is NOT COVERED by this Limited Warranty and (ii) increases the preparatory work that must be performed by the Warranty Holder or its agents in order to properly finish and maintain the Product in a manner not inconsistent with Therma-Tru’s recommendations and instructions. This is particularly a consideration for steel Products.
- Therma-Tru Same-Day, stain finishing product is recommended for staining and top coating fiberglass Products that do NOT have a Therma-Tru factory-applied exterior finish, that is, for Classic-Craft®, Fiber-Classic®, and Pulse™ Product, and is covered by a separate 5-year limited warranty from the date of purchase. (Request a copy for all terms and provisions from Therma-Tru as indicated in Section 6 below or from your builder, dealer or contractor who installed or sold the Product.)
- See Therma-Tru’s recommendations and guidance for proper finishing of fiberglass and steel Products at [www.thermatru.com](http://www.thermatru.com) (i) “Recommendations For Proper Finishing and Painting or Staining”, and (ii) “Frequently Asked Questions”.

## Fiberglass & Steel Door Systems *Continued*

### SUMMARY OF LIMITED WARRANTY PERIODS FOR PRODUCTS – for Residential Warranty Holders Effective January 2014

This table summarizes for Residential Warranty Holders the Warranty Periods under this Limited Warranty that apply to Products when the following genuine Therma-Tru<sup>®</sup> manufactured or recommended components are incorporated into the Door System. This table is provided for your convenience ONLY. READ the entire Limited Warranty for the conditions and limitations that apply to this information. Commercial/Multi-Resident Warranty Holders are subject to different Warranty Coverage, Warranty Periods and Transferability restrictions which are stated in Section 1(c) “Warranty Duration”.

See Notes (*)	Fiberglass		Steel	
	Classic-Craft. Fiber-Classic. Smooth-Star. Pulse <sup>™</sup>	Profiles <sup>™</sup> Wood Edge Pulse <sup>™</sup>	Traditions Wood Edge	Therma-Tru. Fire Door (TR 12-24) Steel Edge
<b>Door System*</b>				
<b>Warranty Period</b>	Lifetime	10 Years	5 Years	15 Years (10 Years within 5 Miles of Salt Water)
<b>Door a/k/a Door Slab and Panels</b> – Applied or inserted	Yes	Yes	Yes	Yes
<b>Fire-Rated **</b>	Select Product Codes (20-minute**)	Select Product Codes (20-minute**)	Select Product Codes (20-minute**)	90-minute**
<b>Glass Lites</b> – Clear, Low-E, Deco, and lite Frames Glazing, seal, internal insert placement, absence of permanent/material obstruction from moisture or dust formation in air space and applied wood grilles	Yes	Yes	Yes (10 Years)	No
<b>Hardware</b> – Hinges Mechanical (excluding (i) installations within 5 miles of a body of salt water and (ii) the finish)	Yes	Yes	Yes	Yes
<b>Lockset</b> – Multi-Point Locking System Mechanical and locking mechanisms (excluding (i) installa- tions within 5 miles of body of salt water, (ii) the finish and (iii) multi-point locking systems installed in steel Products)	Yes	No	No	No
<b>Corner Seal Pad</b> – (excluding normal wear and tear)	Yes	Yes	Yes	Yes
<b>Sills</b>	Yes	Yes	Yes	Yes
<b>Door Bottom Sweep (Gasket) and Weatherstrip</b> – (excluding normal wear and tear)	Yes	Yes	Yes	Yes
<b>Rain guard/Rain deflector</b> – (Optional)	Yes	Yes	Yes	Yes
<b>Aluminum or Stainable Astragal</b> – (Optional)	Yes	Yes	Yes	Yes
<b>Frames</b> – Rot-resistant and sourced from Therma-Tru	Yes	Yes	Yes	Yes
<b>Frames and Framing Components</b> – of any type that are <u>not sourced from Therma-Tru</u> (see Sections 2(a), 10th bullet)	No	No	No	No
<b>Tru-Defense. Door System eligibility and Warranty Rider</b>	***			

\*A “door” and a “door system” are not the same. A “door system” is assembled by a person (for example, your builder, contractor, dealer, or distributor) who sources and combines various separate components, including the “door Slab,” into an entry system. If your door system is assembled using all genuine Therma-Tru parts, then you receive far more than just a beautiful door. You are purchasing an entry system in which every component has been manufactured or recommended by Therma-Tru to work together as an integral “door system” ...AND you will get the full benefit of a Therma-Tru door system limited warranty.

\*\*A 20-minute Fire-Rated door must be permanently labeled with a fire door certification label to signify that the Product is qualified as Fire-Rated. To determine if an eligible door has been machined and is certified for use as a fire door, an official fire door certification label will be affixed, usually between the top and middle hinge, on the edge of the hinge side of the door slab. In the event that a fire door certification label is missing or has been removed, for a Fire-Rated door to retain its fire rating it must be field labeled by the certification entity that originally certified the door (usually Warnock Hersey Intertek or Underwriters Laboratories). A Therma-Tru Fire Door (TR12-24) Steel Edge must be installed with a Therma-Tru Adjusta-Fit. 2 frame with a lock bore sleeve, and a smock and draft intumescent seal to achieve a 90-minute or 60-minute positive pressure rating.

\*\*\*Tru-Defense Fiberglass Door System: A Therma-Tru Fiberglass door system may qualify for supplemental reimbursement under the Tru-Defense. Door System Warranty Rider that provides for additional payment to the Warranty Holder of up to a maximum of \$2,000 reimbursement if water infiltrates under a properly assembled, installed and maintained fiberglass door system that meets the additional provisions stated in the Tru-Defense. Door System Warranty Rider. A copy of the Tru-Defense. Door System Warranty Rider for Fiberglass Door Systems is available for Therma-Tru Corp., 1750 Indian Wood Circle, Maumee, Ohio 43537, at 800-537-5322 or at [www.thermatru.com](http://www.thermatru.com), or from the builder, dealer or contractor who installed or sold the Product.

## Fiberglass & Steel Door Systems *Continued*

### c) WARRANTY PERIOD:

Product	Warranty Holder Classification	
	Residential Warranty Holder	Commercial/Multi-Resident Warranty Holder
Fiberglass: • Classic-Craft® Doors • Fiber-Classic® Doors • Smooth-Star® Doors • Pulse™ Doors	Lifetime <sup>1</sup>	3 Years <sup>3</sup>
Steel: • Profiles™ (Wood Edge Doors) • Pulse™ (Wood Edge Doors)	10 Years <sup>2</sup>	1 Year <sup>3</sup>
Steel: • Traditions (Wood Edge Doors)	5 Years <sup>2</sup>	1 Year <sup>3</sup>
Steel: • Therma-Tru™ Fire Door (TR 12-24) Steel Edge Doors	15 Years <sup>2</sup> (10 Years <sup>2</sup> within 5 Miles of Salt Water)	1 Year <sup>3</sup>

<sup>1</sup> Measured from date Product was originally purchased from an authorized dealer and continuing for as long as the original Residential Warranty Holder owns and resides in the premises in which the Product was installed (“Lifetime Limited Warranty”), unless a shorter duration is expressly stated for the Product component. Not transferable.

<sup>2</sup> Measured from date Product was originally purchased from an authorized dealer and continuing for the stated duration period as long as the original Residential Warranty Holder owns and resides in the premises in which the Product was installed during that entire duration period. Not transferable.

<sup>3</sup> Measured from the earlier of the date Product was shipped from Therma-Tru or an authorized dealer; transferable to successor Commercial/Multi-Resident Warranty Holder during and for the balance of the original Commercial/Multi-Resident Warranty Period.

### d) WARRANTY HOLDER CLASSIFICATIONS:

**RESIDENTIAL WARRANTY HOLDERS:** If the Product is installed in (i) a new residential dwelling and the first occupant owns the dwelling or (ii) an existing owner-occupied residential dwelling, and in each case, at the time of installation such owner is also responsible for Product replacement, then that owner is a Residential Warranty Holder. For example, assume the Product is installed in a condominium unit (a “dwelling”) in a multi-resident building. If the first occupant of the condominium unit is the first owner of that unit and is also responsible for Product replacement, then that owner is a Residential Warranty Holder; however, if the owner is not the first occupant or if someone else other than the owner (for example, the condominium association) is responsible for Product replacement, then the owner is not a Residential Warranty Holder.

**COMMERCIAL/MULTI-RESIDENT WARRANTY HOLDERS:** If the Product is installed under conditions in which no one qualifies as a Residential Warranty Holder as described above, then the warranty holder is the owner of the dwelling or building in which the Product has been installed at the time of installation (and its builder and contractor). That owner is classified as a Commercial/Multi-Resident Warranty Holder. For example, this includes owners of commercial or investment buildings, or multi-resident premises in which the occupant is not responsible (other than through periodic fees/other assessments) for Product replacement whether or not the occupant owns the residential dwelling unit in the premises (including by example, certain condominiums, town homes, duplexes, apartments, cooperatives).

## 2. WHAT THIS LIMITED WARRANTY DOES NOT COVER

This Limited Warranty does not include non-conformities or damages attributable to or arising from:

### a) GENERALLY:

- General wear and tear, including without limitation, wear and tear of weatherstrip, corner seal pads, door bottom sweep (gasket) or the multi-point locking system.
- Minor scratches or minor visual imperfections outside the Product’s standard manufacturing and quality specification parameters.
- The finish on a multi-point locking system (door handles and lockset) and hinges is not warranted and is purchased “AS IS.” This includes but is not limited to finish discoloration, tarnishing, scratches, abrasions and visual imperfections. Exposure to certain environmental conditions, including but not limited to, salt spray, acid rain, high humidity or other corrosive elements may adversely affect the coatings on finishes (as well as the mechanical and multi-point locking

## Fiberglass & Steel Door Systems *Continued*

system (door handles and lockset) mechanisms). Timely and proper cleaning of hinges and a multi-point locking system will help to extend the finish appearance (and mechanical mechanisms) and discourage the possibility of rust and corrosion. Hinges and a multi-point locking system (door handles and lockset) should be wiped down periodically with a soft, water-dampened cloth and dried off with a soft dry cloth. Abrasive cleaners or other harsh chemicals should never be used on hinges or a multi-point locking system (door handles and lockset). Maintenance of the finish (and mechanical mechanisms) is the responsibility of the Warranty Holder.

- The mechanical mechanism on hinges installed within 5 miles of a body of salt water.
- The mechanical and locking mechanism on the multi-point locking system if the Product is installed within (5) miles of a body of salt water or installed on any steel Products. The Warranty Holder is responsible for maintaining the mechanical features of hinges and the multi-point locking system in the same manner as noted in the 3rd bullet above. Therma-Tru does not recommend the use of multi-point locking systems with steel Products. If any multi-point locking system is used with steel Products, its use is "AS IS" WITH NO WARRANTIES.
- EXPRESS OR IMPLIED WARRANTIES, INCLUDING NO WARRANTIES OF MERCHANTABILITY OR FITNESS FOR A PARTICULAR PURPOSE, AND THE OTHER PROVISIONS OF SECTIONS 4 AND 5 OF THIS LIMITED WARRANTY APPLY.
- Negligence; improper use; incorrect installation or finishing (with stain, paint or varnish, or in any manner); lack of maintenance (including failure to properly maintain finish, see "NOTES ABOUT TIMELY FINISHING OF DOOR SYSTEMS" above); or operation inconsistent with Therma-Tru. recommendations and written instructions that are generally available in Therma-Tru Product Manual as updated by bulletins or other written communications, or on the Therma-Tru website at [www.thermatru.com](http://www.thermatru.com). STEEL PRODUCTS, PARTICULARLY THOSE INSTALLED WITHIN FIVE 5 MILES OF A BODY OF SALT WATER, REQUIRE PROMPT AND CAREFUL INITIAL FINISHING AND MAINTENANCE BY THE WARRANTY HOLDER, INCLUDING PERIODIC CLEANING, FINISHING AND REFINISHING, AND OTHER REPAIRS in accordance with Therma-Tru's above referenced recommendations and written instructions.
- Improper pre-installation storage, including inadequate shelter or inadequate venting of shipping wrap in humid locations.
- Misapplication of Products or faulty building design or construction, including inadequate flashings, caulking, building settlement or structural failures of walls or foundations, or inadequate overhangs.
- Installation in locations or a manner that exceeds or deviates from Product design standards and/or testing and certified performance specifications, and/or not in compliance with building codes.
- Product reinstalled after removal from its original installation, except in connection with proper and timely maintenance of components which incur normal wear and tear, such as the weatherstrip, door bottom sweep (gasket) and corner seal pads.
- Rotting, splitting, warping, swelling or other adverse condition, of or attributed to or arising from a frame system, unless the frame system is a genuine Therma-Tru rot-resistant component part (Therma-Tru Primed Pine or Therma-Tru Oak jambs, mullions and brickmould are not Rot-Resistant components). Use of a non-Therma-Tru frame system by the Warranty Holder (or its door system dealer, distributor, builder, installer, contractor or other agent) will not automatically void this Limited Warranty. However, while Therma-Tru recommends the use of a rot-resistant or rot-free frame, Therma-Tru does NOT warrant the performance or integrity of any third party frame product (even if the manufacturer claims that its frame product is rot-resistant or rot-free), and therefore, this Limited Warranty will not apply to Product non-conformities or damages attributed to or arising from the rotting, splitting, warping, swelling or any other condition of a third party frame product.
- Damages aggravated or worsened because of failure by the Warranty Holder or its agents to timely take reasonable actions to mitigate any alleged damages or failure to file a claim for alleged damages promptly and during the Warranty Period.
- Harsh natural environmental conditions, including by example, from substantial exposure to sun, salt spray, or airborne pollutants; other severe conditions including exposure to harsh chemicals or solvents, such as acidic brick washes or stucco leach; or damage from vandalism, or domestic or wild animals.
- Therma-Tru does not manufacture storm doors and is not responsible for any failure of, or any damage caused to, the storm door. PVC lite frames and simulated-divided lite bars are not recommended to be installed behind a storm door. However, the use of a properly installed and properly vented storm door along with a Therma-Tru door system does not void this Limited Warranty. The Therma-Tru door system will continue to be subject to the terms and provision of this Limited Warranty.
- Labor for removing, installing or replacing Product or components or labor for other materials that are removed, reinstalled or refinished in conjunction with repairing or replacing the Product or component.
- Any painting, staining, scratching or other alteration of a Therma-Tru factory-applied exterior coating surface of the Products.

## Fiberglass & Steel Door Systems *Continued*

- Fading, discoloration or color change of a Therma-Tru factory-applied color coating that equals or is less than five 5 Delta E units, calculated in accordance with ASTM E 308-85, ASTM E 805-81 and ASTM D 2244-85, effective on the date the Product is manufactured, and which covers less than a material portion of the exterior of the Product. Color change will be measured on an exposed color surface of the Product that has been properly maintained and cleaned of soils, and the corresponding values measured on the original or unexposed color surface. Non-uniform fading or color change is a natural occurrence if the exterior surfaces of the Product are not equally exposed to the sun and other environmental conditions.
- Products not installed in the USA or Canada.

### **b) GLASS:**

- Minor variations in glass color or imperfections that do not affect the structural integrity of the glass or do not permanently and materially obstruct vision from moisture formation between the panes.
- Glass covered with aftermarket window films.
- Accidental glass breakage, including by example, caused by debris or foreign objects striking the glass, or breakage that may occur under conditions exceeding the Product's performance parameters.
- Condensation, frost or mold resulting from humidity within the building and interior/exterior temperature differentials. Note: There is no such thing as a "condensation-free" window in high-humidity conditions. Controlling the amount of moisture in your home is the most effective action you can take to avoid condensation.
- Stresses from localized heat which cause excessive temperature differentials over the glass.
- Post-manufacture dissipation of inert gases (as argon) or the amount of gas in Products with inert gas-filled insulating glass.
- Scratches or other imperfections, unless readily observable more than 4 feet away.
- Any sound that occurs from decorative grids striking the glass due to vibrations from daily use or outside traffic is not considered an imperfection, nor is the grid touching the glass (primarily in triple-pane window units) considered a defect.
- Mineral deposits.
- The alteration or application of any aftermarket films, coatings, tints or other similar products not originally supplied by Therma-Tru will void this Limited Warranty.

### **c) ADDITIONAL LIMITATIONS, EXCLUSIONS AND CONSIDERATIONS:**

- This Limited Warranty does not guarantee safety for persons or property, nor make a premises hurricane-proof or impact-proof. Follow weather and news reports in order to assess severe weather situations, and obey local authorities' shelter and evacuation orders.
- This Limited Warranty does not cover damage attributable to or caused by acts of God that include, but are not limited to, stresses, high winds, floods, fire and other conditions that exceed Product designs and testing specifications that are test evaluated and certified as referenced in Therma-Tru's published literature. CERTIFICATION APPROVAL, RATING AND REFERENCES TO OTHER PERFORMANCE STANDARDS MEAN THAT THE PRODUCT MEETS THE ESTABLISHED SPECIFICATION PARAMETERS OF THE CERTIFICATION PROCESS OR STANDARD TESTING AT THE TIME THE PRODUCT IS MANUFACTURED. However, with exposure over time to environmental conditions, including by example, high-wind events and other forces of nature, the Product will be subjected to normal and abnormal wear, and its performance capability may change. It is the Warranty Holder's (and its building agents) responsibility to consult local building code laws, and the certification and rating agencies published materials and websites for guidelines on the standards necessary to meet all regulations and codes in the area where the Product will be installed.
- Product features designed to help address pressurization of a building during high-wind or other severe storm events are not a guarantee against water and air infiltration, and Therma-Tru® is not responsible for claims or damages caused by water or air infiltration of Product.
- Product selection is the sole responsibility of the Warranty Holder and its building agents, not Therma-Tru.
- Damage from failure to inspect Product following each high-wind or impact event is not covered under this Limited Warranty.
- This Limited Warranty will be void if the Product rusts due to reasons other than non-conformities in material and workmanship, including without limitation, rusting (on steel Products) arising from misuse, abrasions, environmental conditions, solvents, corrosives, salts, chemicals, excessive moisture or any other damage due to normal wear and tear that could have been addressed by routine, timely and proper initial finishing or periodic corrective maintenance.



## Fiberglass & Steel Door Systems *Continued*

### 3. THIS LIMITED WARRANTY'S EXCLUSIVE REMEDY

If the Product or any components fail to meet this Limited Warranty, Therma-Tru's sole obligation is to either (as Therma-Tru elects):

- Repair the component(s) (color and graining matching not guaranteed), or
- Provide replacement component(s) to the Warranty Holder or Therma-Tru's dealer designated (color and graining matching not guaranteed), or
- Refund the Warranty Holder's purchase price (the lesser of the original Product/component purchase price or the original catalog list price).

Repaired or replaced components are warranted only on the same terms and for the remainder of the Warranty Period. Therma-Tru reserves the right to discontinue or change any Product. If the Product or component is not available, Therma-Tru may select and provide a replacement Product or component of equal quality and price. This is the Warranty Holder's sole and exclusive remedy for the Product under this Limited Warranty. By example but not limitation, this Limited Warranty does not cover any of the following costs and expenses: (i) labor for removing, reinstalling, refinishing Product (or other materials that are removed, reinstalled or refinished to repair or replace the Product); (ii) shipping/freight expenses to return the Product to Therma-Tru; (iii) normal maintenance; (iv) consequential, special or indirect losses or damages of any kind.

### 4. DISCLAIMER OF WARRANTIES

THIS LIMITED WARRANTY IS IN LIEU OF AND EXCLUDES ALL OTHER WARRANTIES NOT EXPRESSLY SET FORTH HEREIN, EXPRESS OR IMPLIED, BY OPERATION OF LAW OR OTHERWISE, INCLUDING BUT NOT LIMITED TO, ANY IMPLIED WARRANTIES OF MERCHANTABILITY OR FITNESS FOR A PARTICULAR PURPOSE. TO THE EXTENT THAT ANY IMPLIED WARRANTIES MAY NONETHELESS EXIST BY OPERATION OF LAW, SUCH WARRANTIES ARE LIMITED TO THE DURATION PROVIDED BY LAW. SOME STATES/PROVINCES/TERRITORIES DO NOT ALLOW LIMITATIONS ON HOW LONG AN IMPLIED WARRANTY LASTS, SO THE ABOVE LIMITATIONS MAY NOT APPLY. THERMA-TRU DOES NOT AUTHORIZE ANYONE TO CREATE FOR IT ANY OBLIGATION OR LIABILITY IN CONNECTION WITH PRODUCTS.

### 5. LIMITATION OF LIABILITY

THERMA-TRU'S SOLE LIABILITY UNDER THIS LIMITED WARRANTY IS REPLACEMENT, REPAIR OR REFUND OF THE PURCHASE PRICE AS SET FORTH ABOVE. IN NO EVENT WILL THERMA-TRU BE LIABLE FOR INCIDENTAL, CONSEQUENTIAL, INDIRECT, SPECIAL OR PUNITIVE DAMAGES, INCLUDING BUT NOT LIMITED TO, DAMAGE OF ANY KIND TO A PREMISES, LOSS OF PRODUCT USE, REINSTALLATION, LABOR, REMOVAL, REFINISHING, TEMPORARY/PERMANENT RELOCATION OF RESIDENTS OR PROPERTY, LOSS OF PROFITS/REVENUE, INTEREST, LOST GOODWILL, WORK STOPPAGE, IMPAIRMENT OF OTHER GOODS OR WORK, INCREASED OPERATING EXPENSES, EMOTIONAL DISTRESS CLAIMS OR CLAIMS OF THIRD PARTIES FOR SUCH DAMAGES, WHETHER BASED ON CONTRACT, WARRANTY, TORT (INCLUDING BUT NOT LIMITED TO, STRICT LIABILITY OR NEGLIGENCE OR OTHERWISE, EVEN IF ADVISED OF THE POSSIBILITY OF SUCH DAMAGES). SOME STATES/PROVINCES/TERRITORIES DO NOT ALLOW THE EXCLUSION OR LIMITATION OF INCIDENTAL OR CONSEQUENTIAL DAMAGES, SO THE ABOVE LIMITATION OR EXCLUSION MAY NOT APPLY. THIS LIMITED WARRANTY PROVIDES SPECIFIC LEGAL RIGHTS, BUT THE WARRANTY HOLDER MAY HAVE OTHER RIGHTS WHICH VARY BY LOCATION. IF THIS LIMITED WARRANTY IS DEEMED TO HAVE FAILED OF ITS ESSENTIAL PURPOSE, IN NO EVENT WILL THERMA-TRU'S ENTIRE LIABILITY EXCEED THE LESSER OF THE PRODUCT'S OR THE NON-CONFORMING COMPONENT'S PURCHASE PRICE.

### 6. CLAIMS

Claims must be initiated during the Warranty Period. To initiate a claim, please contact the builder, dealer or contractor who installed or sold the Product. If that party is unknown or unreachable, contact Therma-Tru Corp., 1750 Indian Wood Circle, Maumee, Ohio 43537 at 800-537-5322 or at [www.thermatru.com](http://www.thermatru.com). Claimant will be required to provide proof of premise ownership and the date of Product purchase and may be required to return the Product or component to Therma-Tru (at Claimant's expense).

Fiberglass & Steel Door Systems *Continued*

**Therma-Tru® Door System Genuine  
Component Part Identification Guide**

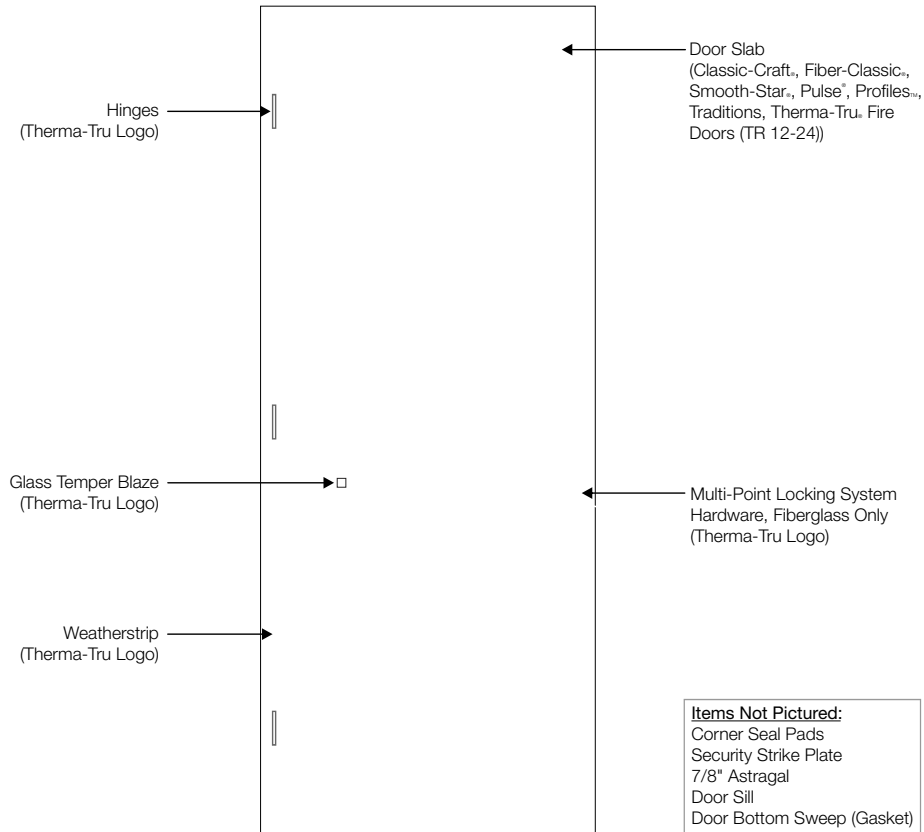

Note: This Limited Warranty applies only to Products purchased and installed in the USA or Canada. For Products purchased or installed outside the USA or Canada, Therma-Tru disclaims any and all warranties of any kind, express or implied, by operation of law or otherwise, and any and all liability for damages of any kind.

©2013 Therma-Tru Corp. All rights reserved. THERMA-TRU and the Therma-Tru Logo are trademarks of Therma-Tru Corp. Registered trademarks are registered in the U.S. and may be registered internationally. Therma-Tru Corp. is an operating company of Fortune Brands Home & Security, Inc.

Effective January 1, 2014  
REV NOV 2013

# Vinyl Sliding Patio Door Systems

## Vinyl Sliding Patio Door Systems

Residential 10-Year Limited Warranty  
For purchases made on or after January 1, 2015  
PVI Sliding Patio Doors

### 1. WHAT THIS LIMITED WARRANTY COVERS AND HOW LONG

#### a) PRODUCT DEFINITION:

THERMA-TRU® DOOR SYSTEM ("Product") consists of a Therma-Tru Vinyl Sliding Patio door slab(s) named above and the following parts when they are genuine Therma-Tru components: any applied or inserted panels, divider bars (if any), glass lite inserts with Therma-Tru logo glass temper blaze, wood grilles (if any), weatherstrip, door bottom sweeps (gaskets), patio door screens, screen tracks, screen stops, internal grids (if any), corner seal pads, door sill, vinyl door frame, slider handle set hardware or multi-point locking system door handles and lockset, footbolts (if any), and slider rollers. This Limited Warranty applies only when all of these parts are genuine Therma-Tru® components.

#### b) COVERAGE:

Subject to the limitations and exclusions below, and for the duration of the applicable Warranty Period, Therma-Tru warrants that Products purchased and installed in the USA or Canada:

NON-GLASS COMPONENTS: Are free from non-conformities in material and workmanship.

GLASS COMPONENTS: Are free from non-conformities in material and workmanship resulting in internal glazing failure, seal failure, internal insert slippage, and permanent and material visual obstruction from moisture or dust film formation in the air space of the sealed glass unit.

#### c) WARRANTY PERIOD:

Residential Warranty Holder: 10 years from the date the Product was originally purchased from an authorized dealer. Not transferable.

Commercial/Multi-Resident Warranty Holder: 3 years from the earlier of the date Product was shipped from Therma-Tru or an authorized dealer; transferable to a successor non-residential owner during and for any balance of the 3 years Warranty Period.

#### d) WARRANTY HOLDER CLASSIFICATIONS:

RESIDENTIAL WARRANTY HOLDERS: If the Product is installed in (i) a new residential dwelling and the first occupant owns the dwelling or (ii) an existing owner-occupied residential dwelling, and in each case, at the time of installation such owner is also responsible for Product replacement, then that owner is a Residential Warranty Holder. For example, assume the Product is installed in a condominium unit (a "dwelling") in a multi-resident building. If the first occupant of the condominium unit is the first owner of that unit and is also responsible for Product replacement, then that owner is a Residential Warranty Holder; however, if the owner is not the first occupant or if someone else other than the owner (for example, the condominium association) is responsible for Product replacement, then the owner is NOT a Residential Warranty Holder.

COMMERCIAL/MULTI-RESIDENT WARRANTY HOLDERS: If the Product is installed under conditions in which no one qualifies as a Residential Warranty Holder as described above, then the warranty holder is the owner of the dwelling or building in which the Product has been installed at the time of installation (and its builder and contractor). That owner is classified as a Commercial/Multi-Resident Warranty Holder. For example, this includes owners of commercial or investment buildings, or multi-resident premises in which the occupant is not responsible for Product replacement whether or not the occupant owns the residential dwelling unit in the premises (including by example, certain condominiums, town homes, duplexes, apartments, cooperatives).

### 2. WHAT THIS LIMITED WARRANTY DOES NOT COVER

This Limited Warranty does not include non-conformities or damages attributable to or arising from:

#### a) GENERALLY:

- General wear and tear, including without limitation wear and tear of weatherstrip, corner seal pads, door bottom sweeps (gaskets), slider rollers, and hardware.
- Minor scratches or minor visual imperfections outside the Product's standard manufacturing and quality specification parameters.
- Negligence; improper use; incorrect installation or finishing (with stain, paint, or varnish, or in any manner); lack of

## Vinyl Sliding Patio Door Systems *Continued*

maintenance (including failure to keep exterior weep holes clear or free of obstructions and interior track free of debris so that door will drain properly); or operation inconsistent with Therma-Tru's recommendations and written instructions that are generally available in Therma-Tru's Product Manual as updated by bulletins or other written communications or on Therma-Tru's website at [www.thermatru.com](http://www.thermatru.com).

- Improper pre-installation storage, including inadequate shelter or inadequate venting of shipping wrap in humid locations.
- Misapplication of Products or faulty building design or construction, including inadequate flashings, caulking, building settlement or structural failures of walls or foundations, or inadequate overhangs.
- Product reinstalled after removal from its original installation, except in connection with proper and timely maintenance of components which incur normal wear and tear, such as the weather strip, door bottom gasket (sweep), and corner seals.
- Products not installed in the USA or Canada.

### **b) GLASS:**

- Minor variations in glass color or imperfections that do not affect the glass' structural integrity or do not permanently and materially obstruct vision from moisture formation between the panes.
- Glass covered with aftermarket window films.
- Accidental glass breakage, including caused by debris or foreign objects striking the glass, or breakage that may occur under conditions exceeding the Product's performance parameters.
- Condensation, frost or mold resulting from humidity within the building and interior/exterior temperature differentials. Note: There is no such thing as a "condensation-free" window in high-humidity conditions. Controlling the amount of moisture in your home is the most effective action you can take to avoid condensation.
- Stresses from localized heat which cause excessive temperature differentials over the glass.
- Post-manufacture dissipation of inert gases (as argon), or the amount of gas in Products with inert gas-filled insulating glass.
- Scratches or other imperfections, unless readily observable more than 4 feet away.
- Any sound that occurs from decorative grids striking the glass due to vibrations from daily use or outside traffic is not considered an imperfection, nor is the grid touching the glass (primarily in triple-pane window units) considered a defect.
- Mineral deposits.
- The alteration or application of any aftermarket films, coatings, tints, or other similar products not originally supplied by Therma-Tru® will void this Limited Warranty.

### **c) ADDITIONAL LIMITATIONS, EXCLUSIONS AND CONSIDERATIONS:**

- This Limited Warranty does not guarantee safety for persons or property, nor make a premises hurricane-proof or impact-proof. Follow weather and news reports in order to assess severe weather situations, and obey local authorities' shelter and evacuation orders.
- This Limited Warranty does not cover damage attributable to or caused by acts of God that include, but are not limited to, stresses, high winds, floods, fire; and other conditions that exceed Product designs and testing specifications that are test evaluated and certified as referenced in Therma-Tru's published literature. CERTIFICATION APPROVAL, RATING, AND REFERENCES TO OTHER PERFORMANCE STANDARDS MEAN THAT THE PRODUCT MEETS THE ESTABLISHED SPECIFICATION PARAMETERS OF THE CERTIFICATION PROCESS OR STANDARD TESTING AT THE TIME THE PRODUCT IS MANUFACTURED. However, with exposure over time to environmental conditions, including by example high-wind events and other forces of nature, the Product will be subjected to normal and abnormal wear, and its performance capability may change. It is the Warranty Holder's (and its building agents) responsibility to consult local building code laws, and the certification and rating agencies published materials and websites for guidelines on the standards necessary to meet all regulations and codes in the area where the Product will be installed.
- Product features designed to help address pressurization of a building during high-wind or other severe storm events are not a guarantee against water and air infiltration, and Therma-Tru® is not responsible for claims or damages caused by water or air infiltration of Product.
- Product selection is the sole responsibility of the Warranty Holder and its building agents, not Therma-Tru.
- Damage from failure to inspect product following each high-wind or impact event. Product that is subject to any high-wind event or the possibility of having been impacted by wind-borne debris should be promptly inspected by the Warranty Holder or by a building professional if the Warranty Holder cannot perform this inspection themselves or if there is concern about Product damage. Proper care and maintenance of the Product is the responsibility of the Warranty Holder and failure to do so may void the Limited Warranty. Although a Product may appear to be in good working condition, the effects of such an event(s) may have adversely affected the ability of the Product to provide subsequent protection against another such event.

## Vinyl Sliding Patio Door Systems *Continued*

### 3. THIS LIMITED WARRANTY'S EXCLUSIVE REMEDY

If the Product or any components fail to meet this Limited Warranty, Therma-Tru's sole obligation is to either (as Therma-Tru elects):

- Repair the component(s) (color and graining matching not guaranteed), or
- Provide replacement component(s) to the Warranty Holder or Therma-Tru's dealer designated (color and graining matching not guaranteed), or
- Refund the Warranty Holder's purchase price (the lesser of the original Product/component purchase price or the original catalog list price).

Repaired or replaced components are warranted only on the same terms and for the remainder of the Warranty Period. Therma-Tru reserves the right to discontinue or change any Product. If the Product or component is not available, Therma-Tru may select and provide a replacement Product or component of equal quality and price. This is the Warranty Holder's sole and exclusive remedy for the Product under this Limited Warranty. By example but not limitation, this Limited Warranty does not cover any of the following costs and expenses: (i) labor for removing, reinstalling, refinishing Product (or other materials that are removed, reinstalled or refinished to repair or replace the Product); (ii) shipping/freight expenses to return the Product to Therma-Tru; (iii) normal maintenance; (iv) consequential, special, or indirect losses or damages of any kind.

### 4. DISCLAIMER OF WARRANTIES

THIS LIMITED WARRANTY IS IN LIEU OF AND EXCLUDES ALL OTHER WARRANTIES NOT EXPRESSLY SET FORTH HEREIN, EXPRESS OR IMPLIED, BY OPERATION OF LAW OR OTHERWISE, INCLUDING BUT NOT LIMITED TO ANY IMPLIED WARRANTIES OF MERCHANTABILITY OR FITNESS FOR A PARTICULAR PURPOSE. TO THE EXTENT THAT ANY IMPLIED WARRANTIES MAY NONETHELESS EXIST BY OPERATION OF LAW, SUCH WARRANTIES ARE LIMITED TO THE DURATION PROVIDED BY LAW. SOME STATES/PROVINCES/TERRITORIES DO NOT ALLOW LIMITATIONS ON HOW LONG AN IMPLIED WARRANTY LASTS, SO THE ABOVE LIMITATIONS MAY NOT APPLY. THERMA-TRU DOES NOT AUTHORIZE ANYONE TO CREATE FOR IT ANY OBLIGATION OR LIABILITY IN CONNECTION WITH PRODUCTS.

### 5. LIMITATION OF LIABILITY

THERMA-TRU'S SOLE LIABILITY UNDER THIS LIMITED WARRANTY IS REPLACEMENT, REPAIR, OR REFUND OF THE PURCHASE PRICE AS SET FORTH ABOVE. IN NO EVENT WILL THERMA-TRU BE LIABLE FOR INCIDENTAL, CONSEQUENTIAL, INDIRECT, SPECIAL, OR PUNITIVE DAMAGES, INCLUDING BUT NOT LIMITED TO DAMAGE OF ANY KIND TO A PREMISES, LOSS OF PRODUCT USE, REINSTALLATION, LABOR, REMOVAL, REFINISHING, TEMPORARY/PERMANENT RELOCATION OF RESIDENTS OR PROPERTY, LOSS OF PROFITS/REVENUE, INTEREST, LOST GOODWILL, WORK STOPPAGE, IMPAIRMENT OF OTHER GOODS OR WORK, INCREASED OPERATING EXPENSES, EMOTIONAL DISTRESS CLAIMS OR CLAIMS OF THIRD PARTIES FOR SUCH DAMAGES, WHETHER BASED ON CONTRACT, WARRANTY, TORT (INCLUDING BUT NOT LIMITED TO, STRICT LIABILITY OR NEGLIGENCE) OR OTHERWISE, EVEN IF ADVISED OF THE POSSIBILITY OF SUCH DAMAGES). SOME STATES/PROVINCES/TERRITORIES DO NOT ALLOW THE EXCLUSION OR LIMITATION OF INCIDENTAL OR CONSEQUENTIAL DAMAGES, SO THE ABOVE LIMITATION OR EXCLUSION MAY NOT APPLY. THIS LIMITED WARRANTY PROVIDES SPECIFIC LEGAL RIGHTS, BUT THE WARRANTY HOLDER MAY HAVE OTHER RIGHTS WHICH VARY BY LOCATION. IF THIS LIMITED WARRANTY IS DEEMED TO HAVE FAILED OF ITS ESSENTIAL PURPOSE, IN NO EVENT WILL THERMA-TRU'S ENTIRE LIABILITY EXCEED THE LESSER OF THE PRODUCT'S OR THE NON-CONFORMING COMPONENT'S PURCHASE PRICE.

### 6. CLAIMS

Claims must be initiated during the Warranty Period. To initiate a claim, please contact the builder, dealer, or contractor who installed or sold the Product. If that party is unknown or unreachable, contact Therma-Tru Corp., 1750 Indian Wood Circle, Maumee, Ohio 43537 at 1-800-537-5322 or at [www.thermatru.com](http://www.thermatru.com). Claimant will be required to provide proof of premises ownership and the date of Product purchase and may be required to return the Product or component to Therma-Tru (at Claimant's expense).

Note: This Limited Warranty applies only to Products purchased and installed in the USA or Canada. For Products purchased or installed outside the USA or Canada, Therma-Tru disclaims any and all warranties of any kind, express or implied, by operation of law or otherwise, and any and all liability for damages of any kind.

©2015 Therma-Tru Corp. All rights reserved. THERMA-TRU and the Therma-Tru Logo are trademarks of Therma-Tru Corp. Therma-Tru Corp. is an operating company of Fortune Brands Home & Security, Inc.

Effective January 1, 2015  
Part #MAWVPD15 MTZT NOV 2014

## Tru-Defense®

### Tru-Defense. Door System Rider

Up to \$2,000 Reimbursement if water infiltrates  
For purchases made on or after January 1, 2015  
Classic-Craft®, Fiber-Classic®, Smooth-Star®, and Pulse(???) Fiberglass Door Systems

This TRU-DEFENSE® DOOR SYSTEM RIDER (“Rider”) supplements the Therma-Tru® Fiberglass and Steel Door Systems Limited Warranty for Classic-Craft®, Fiber-Classic®, Smooth-Star®, and Pulse® Fiberglass Door System Products of Therma-Tru in effect on the purchase date (“Limited Warranty”) and provides for additional payment to the Warranty Holder of up to a maximum of \$2,000 reimbursement if water infiltrates solely as a result of non-conformities in the Tru-Defense Door System.

Except as modified by this Rider, all terms of the Limited Warranty remain in full force and effect. Capitalized terms in this Rider have the same meaning as set forth in the Limited Warranty. FOR A COPY OF THE LIMITED WARRANTIES, OR TO VIEW A PICTURE OF ANY OF THE PRODUCTS OR COMPONENTS REFERRED TO IN THIS RIDER, contact an authorized Therma-Tru dealer, or contact Therma-Tru Corp., 1750 Indian Wood Circle, Maumee, Ohio 43537 at 1-800-537-5322, or visit Therma-Tru’s website at [www.thermatru.com](http://www.thermatru.com).

### 1. WHAT PRODUCTS THIS RIDER COVERS

Therma-Tru Classic-Craft, Fiber-Classic, Smooth-Star, Pulse Fiberglass Door Systems that include ALL OF THE FOLLOWING Therma-Tru approved components (“Tru-Defense Door System” or “System” or “Product”):

- Therma-Tru Classic-Craft, Fiber-Classic, Smooth-Star, or Pulse fiberglass door slab (and any applied or inserted panels)
- Therma-Tru 7-shape corner seal pads (inswing Systems only)
- Therma-Tru composite adjustable profiled inswing sill (excludes composite adjustable sills with visible screw cap plugs; that is, excludes Therma-Tru’s “Basic Composite Adjustable” sill)
- Therma-Tru composite profiled outswing sill
- Therma-Tru dual-bulb door bottom sweep (gasket) (inswing Systems only; no applied door bottom sweep (gasket) on outswing Systems)
- Frame that meets the dimensional machining requirements of the Tru-Defense frame specifications\*
- Therma-Tru hinges, weatherstrip, glass lites, wood grilles, and jamb plugs
- Therma-Tru multi-point locking system or approved Therma-Tru double-bored lock and dead bolt system; that is, any ANSI Grade 1 or Grade 2 Hardware System
- Therma-Tru 7/8 inch aluminum or stainable astragal on double door Systems
- Therma-Tru rain guard (required for outswing Systems)

\*Use of Therma-Tru primed pine jambs, primed pine mullions, primed pine brickmould, oak jambs, oak mullions, oak brickmould, and mull casing, or use of any non-Therma-Tru jambs, mullions, brickmould or mull casings, does not disqualify the above described door system from this Rider, however, none of these types of frames or components are covered by Therma-Tru’s Fiberglass and Steel Door Systems Limited Warranty.

If the Tru-Defense Door System includes all of the applicable components referenced above, and ALSO includes a Therma-Tru sill pan installed in accordance with Therma-Tru’s published instructions, then the Supplemental Reimbursement amount to which the Warranty Holder is otherwise entitled to receive under this Rider will DOUBLE as indicated in the table in Section 3.

### 2. THIS RIDER’S COVERAGE AND HOW LONG

Therma-Tru provides to the Warranty Holder of a Tru-Defense Door System the SAME Limited Warranty for the applicable Warranty Period as stated in the Limited Warranty, PLUS the supplemental reimbursement stated in this Rider. This Limited Warranty applies only to Tru-Defense Door Systems purchased and installed in the USA or Canada.

### 3. THIS RIDER’S SUPPLEMENTAL REIMBURSEMENT AND EXCLUSIVE REMEDY

If the Tru-Defense Door System (“Product”) has been properly assembled and installed by third parties, and properly maintained by the Warranty Holder, and the Product (or components) fail to perform during the Warranty Period solely due to non-conformities in the Product as warranted under the Limited Warranty and this Rider, then **Therma-Tru will:**

- (i) Provide a factory-authorized repair or replacement Product (component), at no cost to the Warranty Holder OR at Therma-Tru’s option, provide replacement Product (component) to the Warranty Holder or the Therma-Tru’s designated dealer (assembly and installation labor is not included), and in either case color matching

Tru-Defense® *Continued*

not guaranteed, OR at Therma-Tru's option, refund the Warranty Holder's purchase price (the lesser of the original Product or component purchase price or the original catalog list price), in lieu of repairing or replacing the Product or components as provided above, AND (ii) Pay to Warranty Holder either, selected at Therma-Tru's option, (a) the fair market value of any other property damaged due to water infiltration caused solely as a result of such non-conforming Product (component), or (b) Warranty Holder's actual reasonable costs to repair or replace such damaged property or install replacement Product (component) supplied by Therma-Tru as provided in above 3(i), in either case, up to the maximum amount listed below for the specified Product ("Water Infiltration Reimbursement Warranty Limit"). Warranty Holder must have taken reasonable steps in a timely manner to mitigate any resulting property damage, provide evidence of costs or damages incurred as requested by Therma-Tru, and timely submit a claim as provided below. If the fair market value of any damaged property is unclear, Therma-Tru may engage a third-party inspector or appraiser for assistance.

	Water Infiltration Reimbursement Warranty Limit		
Tru-Defense® Door System (Product)	Multi-Point Locking System	Multi-Point Locking System	Latch & Deadbolt
Therma-Tru Door	NAFS-Certified Door System*	Standard Door System	Standard Door System
With Therma-Tru Sill Pan	\$2,000	\$1,500	\$500
Without Therma-Tru Sill Pan	\$1,000	\$750	\$250

\*If the Tru-Defense® Door System is certified to the North American Fenestration Standard AAMA/WDMA/CSA 101/I.S.2/A440 (NAFS) and bears the original certification label (check door-hinge edge), the Product is a "NAFS-Certified Door System". A NAFS-Certified Door System requires an independent third party such as NAMI, AAMA, WDMA, CSA, or Keystone to provide certification, inspection, and ensure quality assurance in accordance with international guidelines as set forth in ISO/IEC 17065 and ISO/IEC 17020. Any other Tru-Defense Door System is a "Standard Door System". THIS RIDER DOES NOT WARRANT THE WORKMANSHIP OF ANY BUILDER, REMODELER, OR OTHER PERSON OR ENTITY THAT ASSEMBLES AND/OR INSTALLS THE TRU-DEFENSE DOOR SYSTEM, NOR ANY DAMAGES CAUSED BY SUCH PARTIES' IMPROPER HANDLING, ASSEMBLY, OR INSTALLATION.

Except as modified by this Rider, repaired or replaced Product (component) is warranted on the same terms as in the Therma-Tru Fiberglass and Steel Door Systems Limited Warranty for Classic-Craft®, Fiber-Classic®, Smooth-Star®, and Pulse(???) Fiberglass Door System Products and only for the remainder of the Warranty Holder's Warranty Period. Therma-Tru reserves the right to discontinue or change the Product (component). If the Product (component) is not available, Therma-Tru may select and provide a replacement Product (component) of comparable quality. Except as provided in this Rider, the Limited Warranty does not cover the following: (i) labor for removing, installing, refinishing the Product (component) or other materials that are removed, reinstalled, or refinished to repair or replace the Product (component); (ii) shipping/freight expenses to return the Product (component) to Therma-Tru; (iii) normal maintenance; or (iv) consequential, special, or indirect losses or damages of any kind. THIS IS THE WARRANTY HOLDER'S SOLE AND EXCLUSIVE REMEDY FOR THE PRODUCT UNDER THE LIMITED WARRANTY AS MODIFIED BY THIS RIDER.

**4. WHAT THIS RIDER DOES NOT COVER AND WHEN THIS RIDER MAY BE VOID**

In addition to the same exclusions and limitations as stated under the Limited Warranty, this Rider will NOT apply to Product non-conformities or damages attributable to or arising from:

- FAILURE OF THE TRU-DEFENSE DOOR SYSTEM DUE TO IMPROPER ASSEMBLY AND/OR INSTALLATION BY A BUILDER, REMODELER, OR OTHER PERSON OR ENTITY THAT ASSEMBLES AND/OR INSTALLS, OR HANDLES THE PRODUCT (COMPONENTS) OTHER THAN THERMA-TRU, inconsistent with recommendations and written instructions provided by Therma-Tru or generally available in Therma-Tru's Product Manual as amended from time to time by bulletins or other written communications or NAFS Test Reports or on Therma-Tru's website at [www.thermatru.com](http://www.thermatru.com).
- Rotting, splitting, warping, or swelling of a frame system, unless the frame system is a genuine Therma-Tru rot-resistant component part. Use of a non-Therma-Tru frame system by the Warranty Holder (or its builder, installer, contractor, or other agent) will not automatically void this Rider. However, while Therma-Tru recommends the use of a rot-resistant or rot-free frame in the Tru-Defense Door System, Therma-Tru does NOT warrant the performance or integrity of any third-party frame product (even if the manufacturer claims that its frame product is rot-resistant or rot-free), and therefore, this Rider will not apply to Tru-Defense Door System non-conformities or damages attributable to or arising from the rotting, splitting, warping, swelling, or any other condition of a third-party frame product.
- Use of an applied door bottom sweep (gasket) of any type on an outswing Tru-Defense Door System.
- Removal or reinstallation of a Tru-Defense Door System or any of its components following original installation except

## Tru-Defense® *Continued*

in connection with proper and timely maintenance of components which incur normal wear and tear, such as the weatherstrip, door bottom sweep (gasket), and corner pad.

- Failure of the Warranty Holder to provide timely normal maintenance to the Tru-Defense Door System.
- Failure to operate the Tru-Defense Door System in accordance with its instructions, including without limitation, fully engaging the entire Therma-Tru-approved locking system whenever the Tru-Defense Door System is closed.
- Failure of the Warranty Holder to timely take reasonable actions to mitigate any property damage.
- Labor, services, and materials to paint, stain, or refinish applied to or adjacent to the Tru-Defense Door System, or other carpentry or other work that may be undertaken that is not part of the Tru-Defense Door System, and which itself or in addition to any other property damage, exceeds the maximum Water Infiltration Coverage Warranty Limit.
- Failure to file a claim for alleged damages promptly and during the Warranty Period.
- Non-application of the Limited Warranty or Rider due to any of their stated terms and provisions.
- Products not installed in the USA or Canada.

### 5. LIMITATION OF LIABILITY AND DISCLAIMER OF WARRANTIES

This Rider, read in conjunction with “THERMA-TRU FIBERGLASS AND STEEL DOOR SYSTEMS RESIDENTIAL LIMITED WARRANTY” for Classic-Craft, Fiber-Classic, Smooth-Star, and Pulse Fiberglass Door System Products, sets forth the Warranty Holder’s sole and exclusive remedy for any Tru-Defense Door System and components non-conformities. Except as modified expressly above in Section 3 (“This Rider’s Supplemental Reimbursement and Exclusive Remedy”), in no case will Therma-Tru be liable to the Warranty Holder or any other person for any consequential, special, or indirect losses or damages of any kind. Without limiting the scope of the foregoing: THE LIMITED WARRANTY AND THIS RIDER ARE IN LIEU OF AND EXCLUDE ALL OTHER WARRANTIES NOT EXPRESSLY SET FORTH THEREIN, EXPRESS OR IMPLIED BY OPERATION OF LAW OR OTHERWISE, INCLUDING BUT NOT LIMITED TO ANY IMPLIED WARRANTIES OF MERCHANTABILITY OR FITNESS FOR A PARTICULAR PURPOSE. TO THE EXTENT THAT ANY IMPLIED WARRANTIES MAY NONETHELESS EXIST BY OPERATION OF LAW, SUCH WARRANTIES ARE LIMITED TO THE DURATION PROVIDED BY LAW. SOME STATES/PROVINCES/TERRITORIES DO NOT ALLOW LIMITATIONS ON HOW LONG AN IMPLIED WARRANTY LASTS, SO THE ABOVE LIMITATIONS MAY NOT APPLY. THERMA-TRU DOES NOT AUTHORIZE ANYONE TO CREATE FOR IT ANY OBLIGATION OR LIABILITY IN CONNECTION WITH PRODUCTS. SOME STATES/PROVINCES/TERRITORIES DO NOT ALLOW THE EXCLUSION OR LIMITATION OF INCIDENTAL OR CONSEQUENTIAL DAMAGES, SO THE ABOVE LIMITATION OR EXCLUSION MAY NOT APPLY. THIS LIMITED WARRANTY PROVIDES SPECIFIC LEGAL RIGHTS BUT THE WARRANTY HOLDER MAY HAVE OTHER RIGHTS WHICH VARY BY LOCATION. IF THIS LIMITED WARRANTY IS DEEMED TO HAVE FAILED OF ITS ESSENTIAL PURPOSE, IN NO EVENT WILL THERMA-TRU’S ENTIRE LIABILITY EXCEED THE LESSER OF THE PRODUCT’S OR THE NON-CONFORMING COMPONENT’S PURCHASE PRICE.

### 6. CLAIMS

Claims under this Rider must be initiated promptly following Warranty Holder’s earliest awareness of a potential issue for which recovery arises under this Rider, and in all cases initiated during the Rider Warranty Period indicated above. To obtain help under this Rider, Warranty Holder should contact Therma-Tru Corp., 1750 Indian Wood Circle, Maumee, Ohio 43537 at 1-800-537-5322 or at [www.thermatru.com](http://www.thermatru.com).

Note: This Warranty Rider applies only to Products purchased and installed in the USA or Canada. For Products purchased or installed outside the USA or Canada, Therma-Tru disclaims any and all warranties of any kind, express or implied, by operation of law or otherwise, and any and all liability for damages of any kind.

©2015 Therma-Tru Corp. All rights reserved. THERMA-TRU and the Therma-Tru Logo are trademarks of Therma-Tru Corp. Registered trademarks are registered in the U.S. and may be registered internationally. Therma-Tru Corp. is an operating company of Fortune Brands Home & Security, Inc.

Effective January 1, 2015

Part #MAWTDWR15 MTZT NOV 2014



# Same-Day® Stain

## Same-Day® Stain

5-Year Limited Warranty

For Purchases Made on or After January 1, 2015

Same-Day® Stain and Topcoat for Use on Therma-Tru® Fiberglass Door Systems and Fypon® Stainable Polyurethane Products

This Same-Day® Stain Warranty is separate from the written warranties that accompany Therma-Tru® Classic-Craft®, Fiber-Classic®, Smooth-Star®, and Pulse® fiberglass entry and patio door systems ("Therma-Tru fiberglass door systems") and Fypon® stainable polyurethane products.

### 1. WHAT THIS LIMITED WARRANTY COVERS AND HOW LONG

#### a) PRODUCT DEFINITION:

The "Product" is "Same-Day Stain" and/or "Topcoat For Same-Day Stain". These Products are part of the "Same-Day® Stain Finishing Kit". When these Products are packaged with various application accessories, including a foam brush, one-size-fits-all gloves, 3 inch natural brush, 2 inch synthetic brush, staining rag, cleaning rags, mineral spirits, stir sticks, test samples, and instructions, the Product is the "Same-Day Stain Finishing Kit".

#### b) COVERAGE:

Subject to the limitations and exclusions herein, Therma-Tru and Fypon warrants to the purchaser ("Warranty Holder") that the Products will be free from non-conformities in material that result in peeling, flaking, blistering, and checking for a period of 5 years from the date of original purchase. This Limited Warranty applies only to use of the Products on Therma-Tru fiberglass door systems and Fypon stainable polyurethane products purchased and installed in the USA or Canada.

THIS LIMITED WARRANTY APPLIES ONLY WHEN THE PRODUCT IS APPLIED TO A THERMA-TRU FIBERGLASS DOOR SYSTEM OR A FYPON STAINABLE POLYURETHANE PRODUCT. IF THE PRODUCT IS APPLIED TO ANYTHING OTHER THAN A THERMA-TRU FIBERGLASS DOOR SYSTEM OR A FYPON STAINABLE POLYURETHANE PRODUCT, THEN NO WARRANTY IS MADE ABOUT THE PRODUCT AND THE PRODUCT IS PURCHASED "AS-IS" WITH NO WARRANTY, EXPRESS OR IMPLIED, INCLUDING NO WARRANTIES OF MERCHANTABILITY OR FITNESS FOR A PARTICULAR PURPOSE.

### 2. WHAT THIS LIMITED WARRANTY DOES NOT COVER

This Limited Warranty does not include non-conformities or damages attributable to or arising from:

- APPLICATION TO ANY FIBERGLASS DOOR SYSTEM NOT MANUFACTURED BY THERMA-TRU OR ANY STAINABLE POLYURETHANE PRODUCT NOT MANUFACTURED BY FYPON.
- Application to any product other than a Therma-Tru fiberglass door system or a Fypon stainable polyurethane product.
- Negligence; improper use or application inconsistent with Therma-Tru or Fypon's recommendations and written instructions found in the "Same-Day Stain Finishing Kit" as updated by bulletins or other written communications or on the websites [www.samedaystain.com](http://www.samedaystain.com), [www.fypon.com](http://www.fypon.com) or [www.thermatru.com](http://www.thermatru.com). Alteration of the Product in any manner, including but not limited to thinning the consistency of the Product.
- Alteration of the Product in any manner, including but not limited to thinning the consistency of the Product.
- Improper handling or storage, including but not limited to allowing the Products to become frozen.
- Application of Products to Therma-Tru fiberglass door systems or Fypon stainable polyurethane products NOT installed in the USA or Canada.
- Normal wear. Harsh natural environmental conditions, including by example, from substantial exposure to sun, salt spray, or airborne pollutants; other severe conditions including exposure to harsh chemicals or solvents, such as acidic brick washes or stucco leach; could adversely affect the duration of the finish. Non-uniform fading or color change is a natural occurrence if the exterior surfaces of the product are not equally exposed to the sun and other environmental conditions.

**3. CERTAIN HANDLING CONSIDERATIONS THAT AFFECT HEALTH AND SAFETY: PRODUCT SELECTION RISKS**  
PRODUCT SELECTION AND USE IS THE SOLE RESPONSIBILITY OF THE WARRANTY HOLDER. THERE ARE HEALTH AND SAFETY RISKS IN USING THE PRODUCTS. CAREFULLY READ THE LABELS ON THE PRODUCTS BEFORE USE. THE INSTRUCTIONS INCLUDE THE FOLLOWING GENERAL WARNINGS, BUT THESE WARNINGS ARE NOT AN EXCLUSIVE LIST OF PRECAUTIONS THAT SHOULD BE TAKEN WHEN USING THE PRODUCTS: USE ADEQUATE VENTILATION; DO NOT TAKE INTERNALLY; AVOID CONTACT WITH SKIN; KEEP THE PRODUCTS OUT OF THE REACH OF CHILDREN; SEEK LOCAL EMERGENCY MEDICAL CARE WHEN NEEDED; KEEP THE PRODUCTS AWAY FROM HEAT, SPARKS, AND FLAMES. FOR ADDITIONAL HEALTH AND SAFETY INFORMATION, REQUEST FROM THERMA-TRU OR FYPON OR REFER TO THE PRODUCTS MATERIAL SAFETY DATA SHEET WHICH ARE AVAILABLE AT [WWW.SAMEDAYSTAIN.COM](http://WWW.SAMEDAYSTAIN.COM), [WWW.THERMATRU.COM](http://WWW.THERMATRU.COM) AND [WWW.FYPON.COM](http://WWW.FYPON.COM).

## Same-Day<sup>®</sup> Stain *Continued*

### 4. THIS LIMITED WARRANTY'S EXCLUSIVE REMEDY

If the Product or any components fail to meet this Limited Warranty, Therma-Tru and Fypon's sole obligation is to either (as Therma-Tru and Fypon elects):

- Provide replacement component(s) to the Warranty Holder or Therma-Tru or Fypon's dealer designated (color and graining matching not guaranteed), or
- Refund the Warranty Holder's purchase price (the lesser of the original Product/component purchase price or the original catalog list price).

Repaired or replaced components are warranted only on the same terms and for the remainder of the Warranty Period. Therma-Tru and Fypon reserve the right to discontinue or change any Product. If the Product or component is not available, Therma-Tru and Fypon may select and provide a replacement Product or component of equal quality and price. This is the Warranty Holder's sole and exclusive remedy for the Product under this Limited Warranty. By example but not limitation, this Limited Warranty does not cover any of the following costs and expenses: (i) labor for removing, reinstalling, refinishing Product (or other materials that are removed, reinstalled, or refinished to repair or replace the Product); (ii) shipping/freight expenses to return the Product to Therma-Tru or Fypon; (iii) normal maintenance; (iv) consequential, special, or indirect losses or damages of any kind.

### 5. DISCLAIMER OF WARRANTIES

THIS LIMITED WARRANTY IS IN LIEU OF AND EXCLUDES ALL OTHER WARRANTIES NOT EXPRESSLY SET FORTH HEREIN, EXPRESS OR IMPLIED, BY OPERATION OF LAW OR OTHERWISE, INCLUDING BUT NOT LIMITED TO ANY IMPLIED WARRANTIES OF MERCHANTABILITY OR FITNESS FOR A PARTICULAR PURPOSE. TO THE EXTENT THAT ANY IMPLIED WARRANTIES MAY NONETHELESS EXIST BY OPERATION OF LAW, SUCH WARRANTIES ARE LIMITED TO THE DURATION PROVIDED BY LAW. SOME STATES/PROVINCES/TERRITORIES DO NOT ALLOW LIMITATIONS ON HOW LONG AN IMPLIED WARRANTY LASTS, SO THE ABOVE LIMITATIONS MAY NOT APPLY. THERMA-TRU AND FYPON DO NOT AUTHORIZE ANYONE TO CREATE FOR IT ANY OBLIGATION OR LIABILITY IN CONNECTION WITH PRODUCTS.

### 6. LIMITATION OF LIABILITY

THERMA-TRU AND FYPON'S SOLE LIABILITY UNDER THIS LIMITED WARRANTY IS REPLACEMENT OR REFUND OF THE PURCHASE PRICE AS SET FORTH ABOVE. IN NO EVENT WILL THERMA-TRU OR FYPON BE LIABLE FOR INCIDENTAL, CONSEQUENTIAL, INDIRECT, SPECIAL, OR PUNITIVE DAMAGES, INCLUDING BUT NOT LIMITED TO DAMAGE OF ANY KIND TO A PREMISES, LOSS OF PRODUCT USE, REINSTALLATION, LABOR, REMOVAL, REFINISHING, TEMPORARY/PERMANENT RELOCATION OF RESIDENTS OR PROPERTY, LOSS OF PROFITS/REVENUE, INTEREST, LOST GOODWILL, WORK STOPPAGE, IMPAIRMENT OF OTHER GOODS OR WORK, INCREASED OPERATING EXPENSES, EMOTIONAL DISTRESS CLAIMS OR CLAIMS OF THIRD PARTIES FOR SUCH DAMAGES, WHETHER BASED ON CONTRACT, WARRANTY, TORT (INCLUDING BUT NOT LIMITED TO, STRICT LIABILITY OR NEGLIGENCE OR OTHERWISE, EVEN IF ADVISED OF THE POSSIBILITY OF SUCH DAMAGES). SOME STATES/PROVINCES/TERRITORIES DO NOT ALLOW THE EXCLUSION OR LIMITATION OF INCIDENTAL OR CONSEQUENTIAL DAMAGES, SO THE ABOVE LIMITATION OR EXCLUSION MAY NOT APPLY. THIS LIMITED WARRANTY PROVIDES SPECIFIC LEGAL RIGHTS, BUT THE WARRANTY HOLDER MAY HAVE OTHER RIGHTS WHICH VARY BY LOCATION. IF THIS LIMITED WARRANTY IS DEEMED TO HAVE FAILED OF ITS ESSENTIAL PURPOSE, IN NO EVENT WILL THERMA-TRU OR FYPON'S ENTIRE LIABILITY EXCEED THE LESSER OF THE PRODUCTS OR THE NON-CONFORMING COMPONENTS PURCHASE PRICE.

### 7. CLAIMS

Claims must be initiated during the Warranty Period. To initiate a claim, please contact the builder, dealer, or contractor who sold the Product. If that party is unknown or unreachable, contact Fypon, LLC / Therma-Tru Corp., 1750 Indian Wood Circle, Maumee, Ohio 43537 at 1-800-537-5322 or at [www.thermatru.com](http://www.thermatru.com). Claimant will be required to provide proof of the date of Product purchase and may be required to return the Product to Therma-Tru (at Claimant's expense).

Note: This Limited Warranty applies only to Products purchased and installed in the USA or Canada. For Products purchased or installed outside the USA or Canada, Therma-Tru and Fypon disclaims any and all warranties of any kind, express or implied, by operation of law or otherwise, and any and all liability for damages of any kind.

©2015 Therma-Tru Corp. All rights reserved. THERMA-TRU and the Therma-Tru Logo are trademarks of Therma-Tru Corp. Therma-Tru Corp. is an operating company of Fortune Brands Home & Security, Inc.

Effective January 1, 2015  
Part #MAWSDS15 MTZT NOV 2014

## Installation & Finishing Instructions

These instructions are intended to provide guidance to a professional door installer. An installer is expected to identify and properly respond to installation situations not addressed by these instructions. This may require the services of a licensed contractor. Therma-Tru is not responsible for improper installation.

### Builder, Subcontractor or Supplier:

Please forward these instructions to the homeowner.

The application performance standards for these products may be governed by the International Residential Code, International Building Code and other state and jurisdictional requirements. Copies of performance ratings are available on our website at [www.thermatru.com](http://www.thermatru.com).

### Installation Instructions for Pre-Hung Door Systems

These installation instructions are designed to assist door installers who have an understanding of carpentry principles, and know how to properly and safely use power tools. The purpose of these instructions is to illustrate how to install a Therma-Tru® door system using methods and materials that help eliminate water related leaks. If the directions are closely followed, the door system will have a long useful life with good resistance to rain related water intrusion problems.

These methods are “tried and true.” They are used widely by builders and remodelers who are serious about managing and keeping water outside the home. Rather than eliminate any steps that may be unclear to you, please call 1-800-THERMATRU and ask for clarification. If you remain unclear, please seek more professional assistance with the installation.

Different parts of the country have different code requirements, which may not be covered in these instructions. The installer is responsible for insuring the installation complies with local codes. If you have unique code requirements that do not appear please contact 1-800-THERMATRU.

**Required Tools & Materials:** 2 & 6 foot Levels, Hammer, Putty Knives (firm & flexible), Framing Square, Caulking Gun, Sturdy Ladder, Shims, Tape Measure, High Quality Elastomeric or Polyurethane Sealant, Screw Gun/Drill - 1/8 inch Drill Bit, Razor Knife, #2 & #3 Phillips Bit, Stapler, Insulating Material, Eye Protection, Water Resistant Barrier, Flashing Material, #8 x 2-1/2 inch Exterior Grade Screws, & Optional Sill Pan.

**Read all instructions before starting.**

### Therma-Tru. Recommended Best Practices

#### Use Water Resistant Barrier and Flexible Flashing:

We recommend the use of a Water

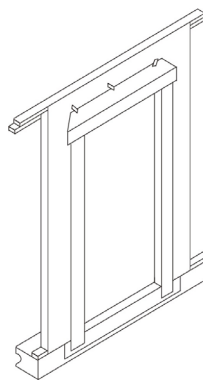

Resistant Barrier (WRB) applied to the exterior sheathing (OSB or other) and the use of an adhesive or flexible flashing product to seal around the opening. The WRB should be cut in the opening (follow manufacturer’s guidelines) with the head of the flap taped up, to be sealed later in Step 11. The flashing should be applied in an overlapping manner as shown, always working from the bottom up (follow manufacturer’s guidelines).

**Use a Sill Pan:** We recommend you first “dry fit” the sill pan in the opening, following the instructions furnished with the sill pan. Place the right and left sill pan ends tight against the sides of the opening. Check the center section for proper length and if necessary, cut with a hack saw or tin snips. Be sure to allow 2 inches of overlap at the joints.

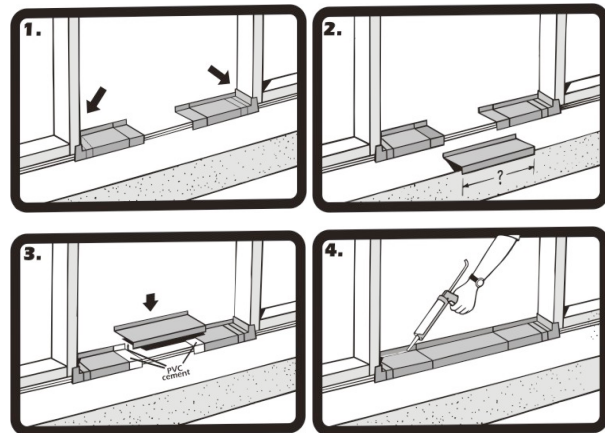

Note: Use only the PVC cement provided in the sill pan kit to glue the pieces together. The sill pan must be sealed to the sub-floor using an Elastomeric or Polyurethane sealant, but do not apply sealant to the bottom of the sill when using a sill pan.

## Installation & Finishing Instructions *Continued*

### Step 1: Check Door Unit.

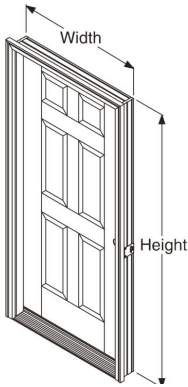

Check width and height. Measure size of frame (width and height), not brickmould. Remove cleats and packaging, but keep door fastened closed with transport clip. Do Not remove the transport clip until instructed to do so later in Step 7.

### Step 2: Check and Prepare Opening.

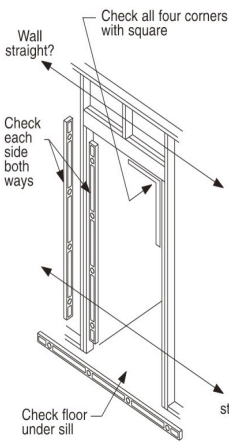

Is the opening the correct size for the door unit? Check it against the door frame size now, before installation. The opening should be frame height plus 1/2 inch, and frame width plus 1/2 inch to 3/4 inch. Fix any problems now.

Are the framing and walls PLUMB? Use a 6 foot level and check both sides of the opening, both ways (front to back and right to left). Fix any problems now.

Is the sub floor level and solid? Provide a flat, level, clean weight bearing surface so the sill pan or sill can be properly caulked and sealed to the opening. Scrape sand or fill as required.

Note: If additional floor covering clearance is required, attach the shim board to the sub floor. Be sure to caulk well under the shim board.

Is the opening square? Check all corners with a framing square. Double check by comparing diagonal measurements. Fix any problems now.

Check to be sure the framing

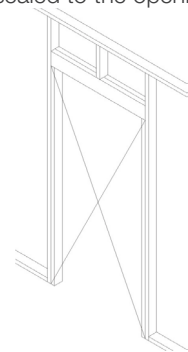

walls around the opening are in the same plane. Do this by performing a "string test" for plumb. String Test for Plumb: Attach a string diagonally across the opening from the outside, as shown. The string(s) should gently touch in the center, if not the opening is "out of plumb" by twice that distance and needs to be corrected. Flip the string over itself to check both planes. Fix any problems now.

\*An "out of plumb" condition is one of the most common reasons door units leak air and water.

### Step 3: Caulk the Sub Floor.

On the sub floor at opening, place 3 very large beads of sealant. Run beads full width of the opening.

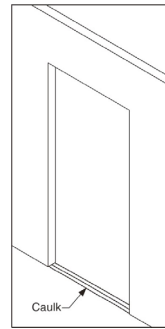

Use Only Elastomeric or Polyurethane sealant.

Use an Entire Tube when Caulking along the Sub Floor.

### Step 3A: Installation With a Sill Pan.

Place the right and left sill pan ends onto the caulk beads and tightly against the side of the opening.

Then, liberally coat the overlapped areas and the recessed areas of the pieces with the PVC cement provided. Place center section(s) in position and hold pieces together long enough to ensure a good bond.

For added protection, spread a bead of caulk along the glue joints and to prevent air infiltration, run a bead of caulk along the lower interior edge of the sill pan. Additional caulking could affect the performance of the sill pan.

Do Not Caulk the bottom of the Sill when using a Sill Pan.

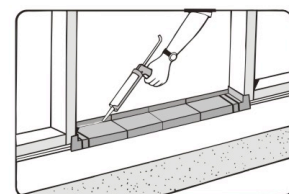
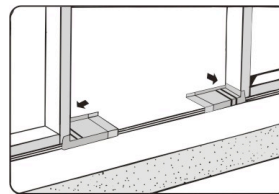

### Step 3B: Installation Without a Sill Pan.

Lay the door unit on edge or face so that the bottom

## Installation & Finishing Instructions *Continued*

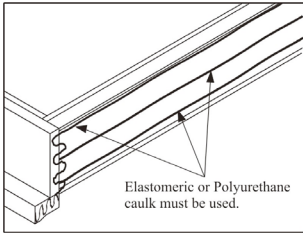

surface of the sill can be caulked. Place very large beads of caulk across the full width of the sill. Additionally, place beads of caulk along the junction of the sill and the jamb and on the bottom surface of the jambs and brickmould.

Note: If a sill extender is used, place a large bead of caulk at the junction of the extender and the sill approach.

### Step 3 cont.: Caulking Back Side of Brickmould.

Important!

Apply sealant to the back side of brickmould around the entire perimeter of the door unit. A 1/2 – 5/8 inch bead of Elastomeric or Polyurethane caulk is essential.

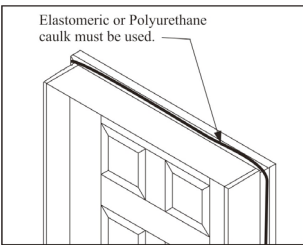

### Step 4: Place Unit in Opening and Temporarily Fasten.

Lift the unit up. With top edge tilted away from opening, center the unit and place sill down onto sill pan or caulk beads and tilt into opening.

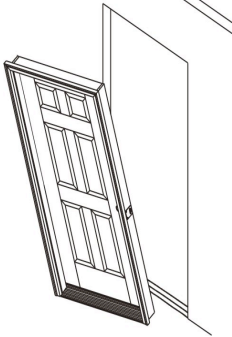

For all door unit configurations, note the hinge locations and mark those locations on the jamb faces near the door surfaces. Pre-drill 1/8 inch diameter holes at these locations for screw placement. A counter sink bit will help to conceal the screw heads.

Install screws in the center pre-drilled hole locations on both jambs to temporarily secure the unit in the place. Do not drive screws completely in at this time.

Use #8 X 2-1/2 inch or 3 inch exterior grade screws. Do Not Fasten through the Brickmould.

### Step 4 cont.: Plumb Hinge Side Jamb.

Work from side of the door that is weatherstripped.

Use a 6 foot level and plumb the hinge side jamb both ways (right to left and inside to outside).

Place screws through the hinge side jamb into the studs, at each remaining hinge location, as shown in the diagrams. Use #8 X 2-1/2 inch or 3 inch exterior grade screws.

Do Not, drive the screws completely in at this time.

For Single or Double Doors, place screws at each hinge location, so shims can be placed behind hinges above screws. The screws will keep the shims from falling down while adjustments are being made.

For Sidelite units, fasten the jamb on the hinge side of the door.

For Double Door and Patio Units, fasten the fixed or passive side of the unit first.

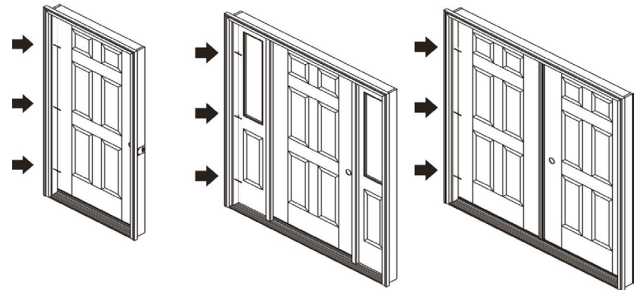

Single Unit

Sidelite Unit

Double Unit

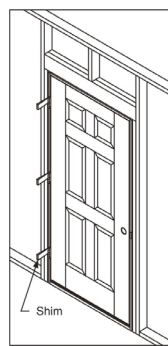

### Step 5: Shim at Hinge Locations and Secure Hinge Jamb.

Leave door fastened and closed with transport clip.

Shim above screws, behind each hinge location, between the opening and the jamb.

Use a 6 foot level and re-check hinge jamb to ensure it is plumb and straight.

Finish driving screws tight in the middle first then top and bottom last.

## Installation & Finishing Instructions *Continued*

### Step 6: Adjust Rest of Frame and Fasten.

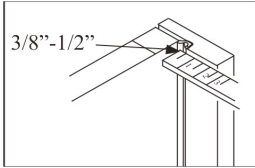

From the weatherstrip side of the door, check weatherstrip margins and contact.

Make frame adjustments so the weatherstrip contacts the door surface equally at the top, middle and bottom, an even 3/8 inch to 1/2 inch when fully closed. Secure the lock side jamb with #8 X 2-1/2 or 3 inch screws through the pre-drilled holes at the top and bottom. Do Not drive screws tight at this time.

From the swing side of the door, shim above the screw locations and make adjustments so the margins between the door and frame are even top to bottom.

Note: For Double Doors, make adjustments that effect the alignment, margins and weatherstrip contact between the doors. Also follow the Astragal Site Package Instructions for details on properly setting the slide bolt hole locations.

### Step 6 cont.: Adjust Rest of Frame and Fasten.



Re-check everywhere for plumb and square, and an even weatherstrip contact.

Finish driving all screws tight.

### Step 7: Remove Transport Clip and Open Door.

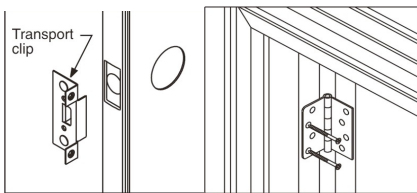

Remove the transport clip.

Open and close door to check for smooth operation.

With the door open, drill 1/8 inch

diameter pilot holes in the top hinge in the 2 screw hole locations closest to the weatherstrip. Then, install the #10 X 2-1/2 inch screws (provided) through the hinge, into the stud, to anchor the door frame and prevent sagging.

### Step 7 cont.: Remove Transport Clip and Open Door.

For Sidelite and Patio Units: With the door open, check to determine if the 2-1/2 inch long hinge screws were pre-installed in the hinges. If not, drill 1/8 inch diameter pilot holes and install the long hinge screws in the hole locations closest to the weatherstrip.

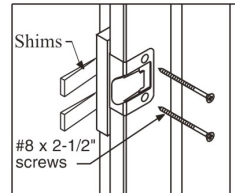

Close the door and carefully shim between the jamb and the opening behind the adjustable strike plate area.

Then open the door and drill 1/8 inch dia. pilot holes and install the #8 X 2-1/2 inch screws

(provided) through the strike plate holes to secure the lock side jamb and provide security.

Adjust strike plate in or out for proper weatherstrip contact and door operation, then finish tightening screws.

### Step 8: Adjust Sill.

Your door unit may have an adjustable threshold cap. When properly adjusted, it should be snug and slightly difficult to pull a dollar bill out from under the door when it is fully closed. The dollar bill should be able to be removed without tearing.

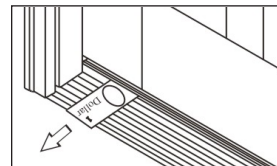

This check should be performed at each adjustment screw location.

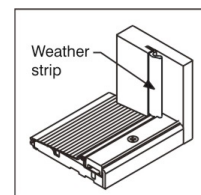

After adjusting the threshold cap, ensure that the weatherstrip is flush with the top of the threshold cap. Trim as necessary.

## Installation & Finishing Instructions *Continued*

### Step 9: Install Corner Seal Pads – Inswing units Only.

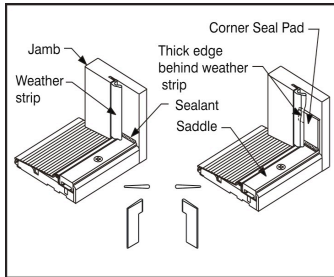

Apply sealant (Polyurethane or Elastomeric) at the joint where the threshold cap meets the door jambs.

Remove the self-stick paper from the corner seal pads and apply to the door jamb, with the bottom lined up evenly

with the top of the threshold cap. When the pad is correctly installed, the tab is on top and the narrow part is on the bottom.

The bottom of the pad is the same width of the threshold cap to help with alignment during installation.

### Step 10: Additional Frame Anchoring.

If sill is prepared for anchoring screws, place appropriate screws through the sill into the sub floor where needed. (Primarily on Outswing Sills)

We recommend that you provide additional frame anchoring as shown here. Certain states or jurisdictions, notably Florida and the coast of Texas, have specific installation requirements and may require installation in strict accordance with the product approval for a specific product. You should always check with the local authority having jurisdiction for any specific installation requirements that may apply. Specific product approval installation instructions, including those required for the High Velocity Zone (HVHZ), are also available at [www.thermatru.com](http://www.thermatru.com)

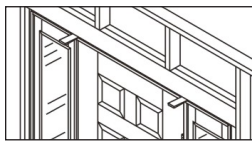

#### Doors With Sidelites:

Shim above mull post or jambs separating doors and sidelites. Screw through the frame into the header, adjacent to the shims.

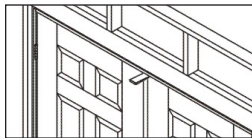

#### Double Doors:

Place temporary shims above the center of the head frame, where doors meet. Pre-drill and insert a screw through frame into header, then remove the temporary shims.

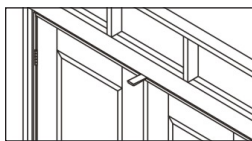

#### Patio Doors:

Shim above the mull post(s). Pre-drill and insert a screw through the frame into the header, at either side of the post.

### Step 11: Weatherproof, Finish and Maintain.

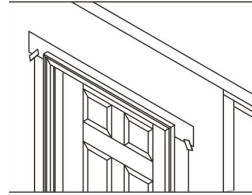

Provide and maintain a properly installed cap or head flashing to protect top of surfaces from Water intrusion and damage. Tape and properly seal the top flap of the Water Resistant Barrier (WRB) over the head flashing.

Caulk around entire “weather” side of unit, sealing along the brickmould to the flashing material or siding and seal all joints between the jambs and moldings.

Seal the joints between the exterior hardware trim and the door face to prevent air and water infiltration.

Place and set galvanized finish nails through the brickmould around the perimeter. Use exterior grade screws if you are installing a storm door to the brickmould. Countersink all fasteners and cover with exterior grade putty.

Add insulation material to the cavity between the opening and the unit to reduce air infiltration and heat transfer.

All Therma-Tru® Steel doors must be finished within several days of the installation date for continued warranty coverage. For Fiberglass doors the finishing requirement is within 6 months of installation.

Paint or stain according to Therma-Tru® Finishing instructions. Do Not paint or stain the weatherstrip, it is “friction-fit” and easily removed for painting or staining.

All 6 sides of the doors must be finished. For out-swing doors the sides, top and bottom must be inspected and maintained as regularly as all other surfaces.

All bare wood surfaces such as the door frame exposed to weather should be primed and painted or stained and top coated within two weeks of exposure for best performance.

Maintain or replace sealants and finishes as soon as any deterioration is evident. For semi-gloss or glossy paint or clear coats, do this when the surface becomes dull or rough. More severe climates and exposures will require more frequent maintenance.

Access our website [www.thermatru.com](http://www.thermatru.com) for printable versions of the installation and Same-Day® stain finishing instructions and to view our Troubleshooting video for minor installation issues and adjustments.

## Installation & Finishing Instructions *Continued*

### **Finishing Instructions.**

Work only when temperatures are between 50° and 90° F and with relative humidity below 80%. Do not finish in direct sunlight.

### **Steel and Smooth-Star Doors:**

To Paint Doors: Clean first with mild detergent and water or use a TSP (tri-sodium phosphate) solution. Rinse well and allow to dry completely. Mask off hardware, glass and remove weatherstripping before painting. Use high-quality acrylic latex house paint, following manufacturer's directions for application. Use exterior grade finishes for outside surfaces. Paint edges and exposed ends of door.

### **To Paint Doorlite Frames:**

Remove any excess glass glazing sealant by first spraying with a window cleaner or water. Use a single edge razor blade to score the glazing along the edge of the frame. Holding the razor blade at a 45 degree angle, scrape glazing from glass. Wipe remaining residue off with window cleaner or mineral spirits. Clean frame with a mild detergent and water, or use a TSP solution. Rinse well and allow to dry completely. Mask off glass. Prime door lite frames with an alkyd- or acrylic-based primer. Allow primer to dry before applying finish paint coats. Use high-quality acrylic latex house paint, following manufacturer's application instructions. Use exterior grade finishes for outside surfaces.

### **Classic-Craft and Fiber-Classic Doors:**

To Finish Doorlite Frames and Panel Inserts: Remove any excess glazing sealant by first spraying with a window cleaner or water. Use a single edge razor blade to score the glazing along the edge of the frame. Holding the razor blade at a 45° angle, scrape glazing from glass. Wipe remaining residue off with window cleaner or mineral spirits. Mask off glass. Paint or stain using same materials as for the door. (See below).

### **To Paint Doors:**

Clean first with mild detergent and water or use a TSP (tri-sodium phosphate) solution. Rinse well and allow to dry completely. Prime with an alkyd- or acrylic-based primer. Allow primer to dry completely, then paint with acrylic latex house paint, following paint manufacturer's application instructions. Use a primer and paint that are compatible. Use exterior grade finishes for outside surfaces. Paint edges and exposed ends of door.

### **To Stain Doors:**

Clean first with a clean cloth and mineral spirits and allow to air dry or wash door with mild detergent and water, or a TSP (tri-sodium phosphate) solution. Rinse well and allow to dry completely. For stained surfaces, we only recommend the use of the stain and clear coat products found in the Therma-Tru® Same-Day® stain Finishing Kit. Apply stain with a rag. The longer the stain is left to "setup" before wiping off, the darker the color will be. Using a clean rag, wipe off the stain to the color shade you desire. Remove any excess stain from the panel grooves with the foam brush provided; allow the stain to dry for at least 6 hours before applying topcoat. See Therma-Tru® Same-Day® stain Finishing Kit instructions for complete details.

### **Warning:**

Modification or machining of this product can release wood dust, a substance known to the State of California to cause cancer.



## Care & Maintenance

### Door System Maintenance

All Therma-Tru® door systems and associated components should be inspected and checked at least once a year for the following conditions: fading of door finishes, weatherstrip seal inadequacies, door bottom gasket or sill gasket wear, and vinyl threshold or oak riser splitting or cracking. Upon inspection if any of these components fail to function, they should be repaired or replaced as follows.

### DOOR FINISHES

#### Clearcoats and Stains

All exterior finishes are affected by exposure and weathering from the sun, moisture and air pollutants. A simple application of a maintenance coat of topcoat will renew the protection over the stained surface on Classic-Craft® and Fiber-Classic® door slabs. Before top coat fails, reapply fresh topcoat. Clean first with a house hold detergent and water. Rinse and let dry. Reapply the topcoat approximately every 3-5 years or when gloss fades. Fading will vary.

HINT: Pull out and compare the sample that was finished when door was new to the door periodically. When compared to the sample, if the door seems rough or has lost its gloss, you need to re-topcoat your door.

#### Paint on Classic-Craft® or Fiber-Classic® Doors

For fading, cracking, splitting, etc., of painted Classic-Craft® or Fiber-Classic® doors, stripping and refinishing may be required.

#### Paint on Smooth-Star® or Steel Doors

For cracking, splitting or deteriorating paint finishes on steel doors, lightly sand surface of door and touch up to match overall finish.

#### Special Note for Outswing Door Systems

Swing-out doors must have all edges - sides, top and bottom - finished. Inspect and maintain these edges regularly as all other surfaces.

### WEATHERSTRIPPING

If the weatherstripping fails to perform (i.e., not sealing the door system properly, cracking, tearing, etc.) the weatherstrip needs to be replaced. Remove the existing weatherstripping and replace.

### DOOR BOTTOM AND SILL GASKETS

If the door bottom gasket fails to perform (i.e., splitting, cracking, pulling away from door slab, etc.), the door bottom needs to be replaced with a new door bottom.

If the sill gaskets on outswing sills fails to perform (i.e., splitting, cracking, etc.), the sill gasket needs to be replaced. Pull the existing gasket and replace the gasketing for proper functioning of the sill.

### RISERS FOR ADJUSTABLE SILLS

If the riser for an adjustable sill fails to perform (i.e., splitting, cracking, etc.), the riser needs to be replaced. Remove the existing riser and replace.

### VINYL THRESHOLDS

If the vinyl threshold fails to perform (i.e., splitting, cracking, etc.), the vinyl threshold needs to be replaced. Remove the existing threshold and replace.

## Care & Maintenance *Continued*

### CORNER SEAL PADS

If corner seal pads are torn or missing, replace corner seal pads.

### SEALING/RESEALING AREAS

If a caulk seal fails to perform (i.e. waterleakage), remove existing seal and reseal area.

### STRIPPING TO REFINISH

1. Choose a standard paint stripper. Paint or stain and topcoat can be removed with most methylene chloride based strippers, such as:

- Savogran® SuperStrip®
- Savogran® Kutzit®
- Dad's Easy Spray® Paint, Stain & Varnish Remover

Follow the paint stripper manufacturer's directions and cautions for correct use. Check with the product manufacturer of your fiberglass door / stainable polyurethane product for details.

2. Apply the stripper, working on small areas at a time.

Tip: For a fiberglass door, apply the stripper to the (A) glass frame first and (B) the raised panels second (see illustration), before moving on to the rest of the door.

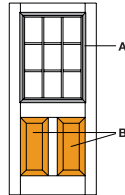

3. Remove the stripper within 2–3 minutes. If your fiberglass door / stainable polyurethane product has a factory-applied primer, it might be removed with long exposure to paint strippers.

Tip: Use a nylon bristle brush for easier removal of paint and stain from the wood-grain texture. For fiberglass doors, grade 000 steel wool can also be used.

4. Wash off the remaining stripper. After the stain or paint has been removed, clean with mild soap and water to completely remove any stripper residue. Rinse well and wipe dry. Make sure the product is completely clean and dry before refinishing.

Dad's and Dad's Easy Spray are trademarks of Sansher Corp.; Savogran and SuperStrip are registered trademarks of the Savogran Company.

## Troubleshooting Guide

For detailed instructions to perform the solutions stated here, refer to the Installation and Finishing Instructions section of this manual on pages 23-28. Service videos are also available on the Therma-Tru website at [www.thermatru.com/installation](http://www.thermatru.com/installation). These videos are designed to help homeowners, installers and service technicians.

### Air and/or Light Leak at Top or Bottom of Jamb

PROBLEM: Air and/or light leak at top or bottom of jamb.

Cause	Solution
Weatherstrip missing. Weatherstrip painted. Weatherstrip cracked, torn or damaged.	Replace weatherstrip.
Bottom corner seal pads missing or removed.	Replace pads.
Door loose in frame, with excessive in-and-out movement when latched.	Adjust strike plate for tighter fit.
Door not meeting weatherstrip evenly when it closes, hitting the top or bottom first.	Realign, reshim, readjust lockside jamb so door meets weatherstrip evenly from top to bottom.

### Water Leakage Around or Under Sill

PROBLEM: Water leakage around or under sill.

Cause	Solution
Door not meeting weatherstrip evenly when it closes, hitting the top or bottom first.	Realign, reshim, readjust lockside jamb so door meets weatherstrip evenly from top to bottom.
Damaged or painted weatherstrip.	Replace weatherstrip.
Improper/insufficient sealant and/or sealant breakdown between sill and subfloor.	Reseal under sill using Elastomeric and Polyurethane sealant.
Broken seal where the sill meets the jamb.	Remove corner seal pad, pull out weatherstrip at bottom, and place a bead of Elastomeric and Polyurethane sealant along entire joint where jamb and sill meet. Replace weatherstrip and reapply corner seal pad.
Sill humped or depressed beyond range of door bottom's sealing capacity.	Anchor sill to draw down straight by drilling pilot holes and securing with galvanized screws. Replace any wrinkled torn door bottom.
Humped sill.	Shim jamb legs up to allow sill to straighten. Reseal with Elastomeric and Polyurethane sealant under sill and anchor sill in place.
Damaged sill saddle causing door bottom bulb seal to bunch up and wrinkle when the unit closes.	Replace the saddle and screw down.
Damaged door bottom.	Replace door bottom, sealing first.
Door sagging out of square in frame.	Make sure LONG hinge screws provided are properly installed in the top hinge through the jamb to the stud.
Jamb out of alignments.	If jamb is twisted along length of the members, straighten it by reshimming to eliminate the twist and maintain an even head margin.
Jamb out of square to door.	Usually caused by plumb frame members sitting on unlevel floor/sill area. Free lowest jamb leg and shim it up to level the sill and maintain an even head margin. Shim under sill if necessary.

## Troubleshooting Guide *Continued*

### Water Leakage Around Door/System Perimeters

PROBLEM: Water leakage around door/system perimeters.

Cause	Solution
Door not meeting weatherstrip evenly when it closes, hitting the top or bottom first.	Realign, reshim, readjust Lockside jamb so door meets weatherstrip evenly from top to bottom.
Improper/incomplete seal and/or sealant breakdown around or on top of unit.	Properly flash and/or seal with Elastomeric or Polyurethane sealant around brickmould.
Improper/incomplete seal and/or breakdown around fixed unit sidelites where they meet the jamb.	Reseal with Elastomeric and Polyurethane sealant to restore system integrity.

### Water Leakage Around Lites

PROBLEM: Water leakage around lites.

Cause	Solution
Loose lites.	Tighten doorlite screws. Apply sealing tape around inside perimeter of interior frame if required.
Door face-to-lite frame seal breakdown.	Seal with Elastomeric and Polyurethane sealant around lite perimeter and/or paint or repaint the perimeter to form a paint seal.
Glass-to-lite frame seal breakdown.	Replace doorlite.

### Water Leakage Around Fiber-Classic® Designline Panels

PROBLEM: Water leakage around Fiber-Classic® Designline panels.

Cause	Solution
Loose panels.	Tighten screws. Apply sealing tape around inside perimeter of interior frame if required.
Door face-to-panel seal breakdown.	Seal with Elastomeric and Polyurethane sealant around panel perimeter and/or paint or repaint the perimeter to form a paint seal.

### Door Will Not Open or Close Properly

PROBLEM: Door will not open or close properly.

Cause	Solution
Door not meeting weatherstrip evenly when it closes, hitting the top or bottom first.	Realign, reshim, readjust lockside jamb so the door meets the weatherstripping evenly from top to bottom.
Adjustable strike plate not properly aligned.	Realign adjustable strike plate.
Door sagging out of square in frame (uneven head margin).	Make sure LONG hinge screws provided are properly installed in the top hinge through the jamb to the stud.
Frame out of square (uneven sill/door bottom margin).	Usually caused by plumb frame members sitting on unlevel floor/sill area. Free lowest jamb leg and shim it up to level the sill and maintain an even head margin.

## Troubleshooting Guide *Continued*

### Spring Loaded Hinge Adjustment Instructions

PROBLEM: Door does not have enough or too much force.

Cause	Solution
Hinge does not have enough force to close and latch the door.	Remove cross pin. Insert 9/64" Allen wrench in hex adjustment hole and turn to left (clockwise). Insert cross pin when next hole lines up. Remove Allen wrench and test closing action of door. Repeat if necessary. Over-tightening may shorten the life of the hinge.  Another hinge may be required.
Too much force cause door to slam and make opening difficult.	Replace one of the hinges with a standard hinge without adjustable tension.

### Classic-Craft. & Smooth-Star. Raised Panels Are Loose or Have Come Off

PROBLEM: Panels are not sticking – need to re-apply

Cause	Solution
Door face to panel adhesive tape breakdown.	Reapply by removing panel. Clean panel and door with 70% Isopropyl Alcohol, taking care to remove all old adhesive. Apply new adhesive tape. Apply adequate pressure.

### Internal Blinds Care & Handling

**Easy cleaning:** Blinds never need dusted. Simply wipe the surface of the glass with a glass cleaner for a polished appearance.

**Reattach the handle:** Tilt the handle and place it back onto the track. Slide the handle up or down the length of the track until two audible clicks are heard. The handle is then properly reattached.

**Uneven blinds:** If blinds become uneven, slide the handle up and down the entire length of the track to bring the blinds back to a straight and even position.

**Replacement parts:** A replacement handle and additional caps for the ends of the track can be ordered by visiting [www.thermatru.com](http://www.thermatru.com) or by contacting Customer Service at 1-800-THERMA-TRU (843-7628).



## Common Replacement Parts

Parts shown in this section can be ordered online at [www.thermatru.com/customer-support/replacement-parts/](http://www.thermatru.com/customer-support/replacement-parts/).

Proper replacement with genuine Therma-Tru® components ensures the component is engineered to work together with your Therma-Tru door as a complete door system.

In this section, you will find part numbers for common replacement parts for your Therma-Tru door including:

- Astragals
- Corner Seal Pads
- Door Bottom Sweeps (Gaskets)
- Sill Gasket
- Foot Bolt Kit
- Divided Lites
- Hinges & Screws
- Plugs on Frame
- Rain Deflector
- Rain Guard
- Weatherstrip
- Internal Blinds
- Same-Day, Stain

Parts shown in this section can be ordered online at [www.thermatru.com/customer-support/replacement-parts/](http://www.thermatru.com/customer-support/replacement-parts/).

For all other parts, please contact your authorized Therma-Tru dealer. A dealer listing can be found at [www.thermatru.com](http://www.thermatru.com).

# Entry Door Parts Identification

This diagram shows the most common replacement parts.

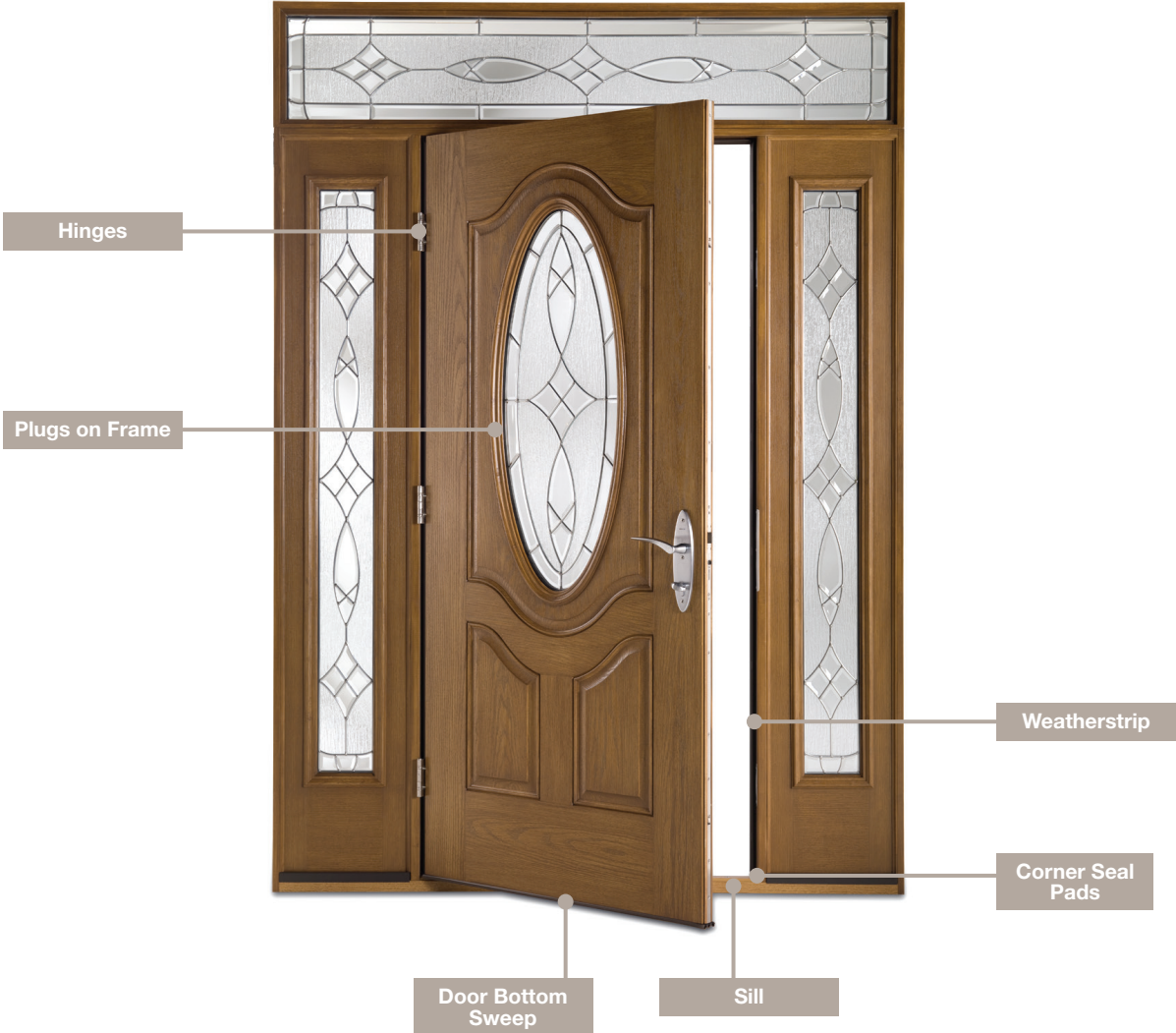

# Double Entry Door Parts Identification

This diagram shows the most common replacement parts.

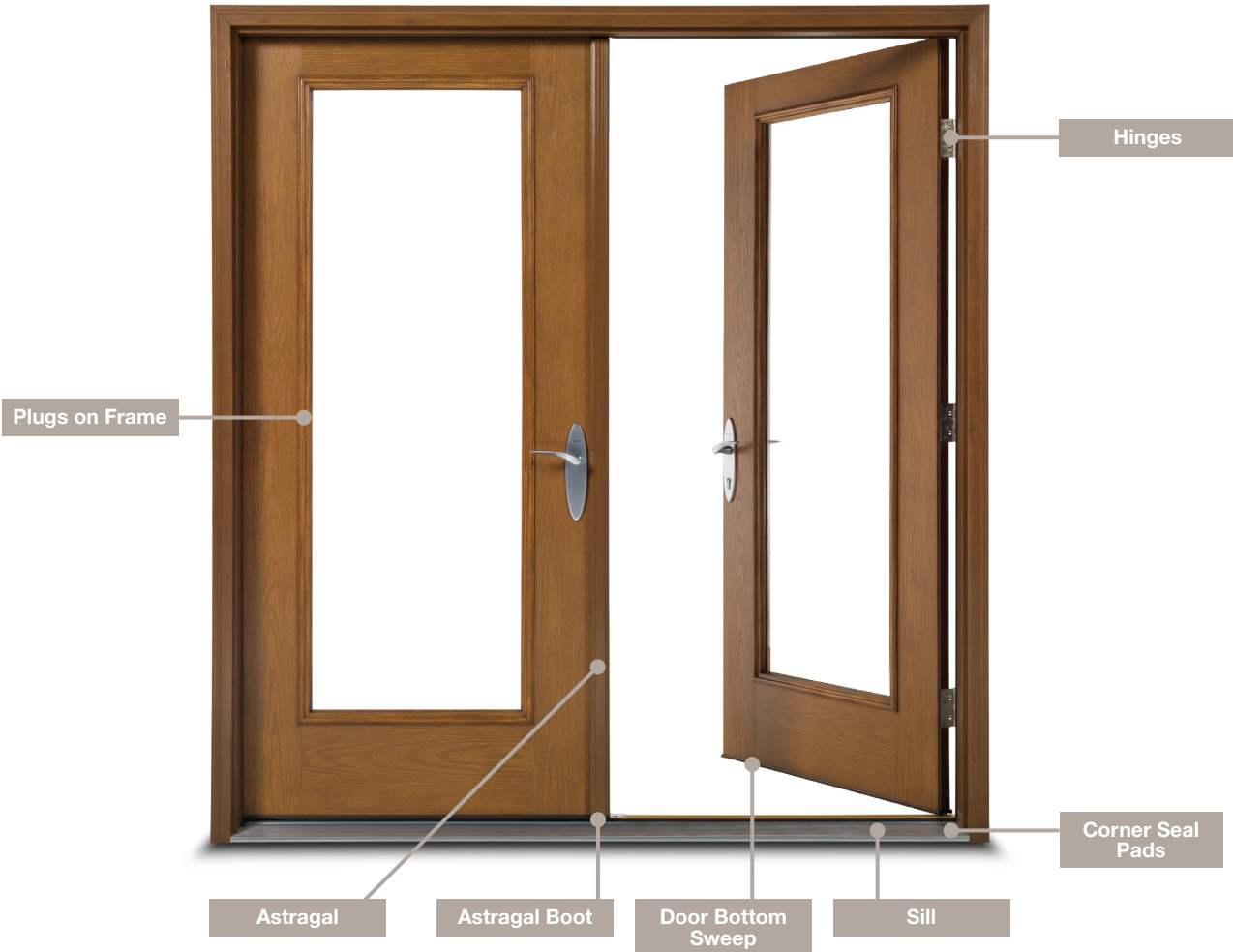



# Astragals

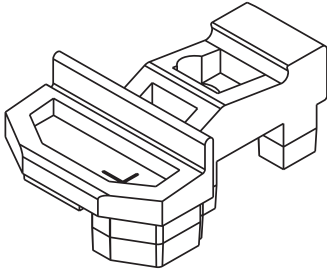

**Part # HASBOTBTL**

7/8" Coastal Astragal  
Left Hand Inswing Bottom Rubber Boot

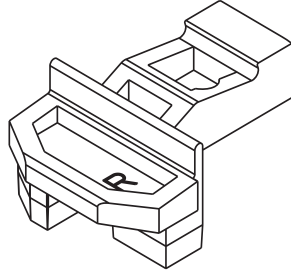

**Part # HASBOTBTR**

7/8" Coastal Astragal  
Right Hand Inswing Bottom Rubber Boot

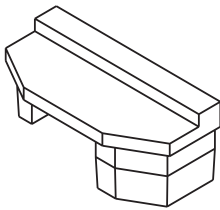

**Part # HASTOPBTL**

7/8" Coastal Astragal  
Right Hand Outswing Bottom Rubber Boot  
or Left Hand Inswing Top Rubber Boot

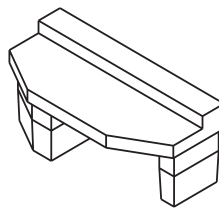

**Part # HASTOPBTR**

7/8" Coastal Astragal  
Left Hand Outswing Bottom Rubber Boot  
or Right Hand Inswing Top Rubber Boot

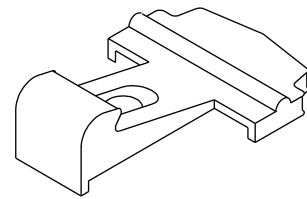

**Part # RPASRB**

Wood Astragal Rubber Boot

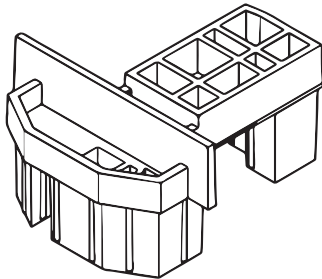

**Part # 7ASTBOOTL450**

7/8" Stainable Aluminum Astragal  
7/8" Standard Aluminum Astragal  
Left Hand Inswing Bottom Rubber Boot

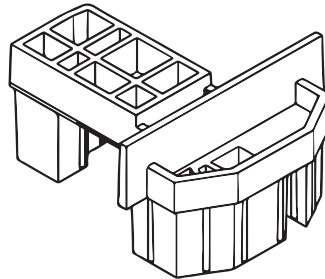

**Part # 7ASTBOOTR450**

7/8" Stainable Aluminum Astragal  
7/8" Standard Aluminum Astragal  
Right Hand Inswing Bottom Rubber Boot

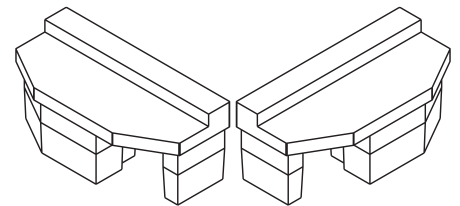

**Part # RPTOPBT**

7/8" Stainable Aluminum Astragal  
7/8" Standard Aluminum Astragal  
Outswing Bottom Boot and Inswing Top Boot  
(Right and Left in Package)

## Astragal Hardware Kits

**Part # RPAHWB**

Astragal Hardware Package

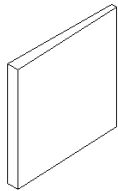

(1) Corner Pad

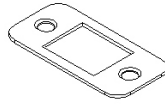

Deadbolt Plate

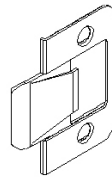

Adjustable Strike  
with Hardware



(1) Header Strike Plate



(2) #6 x 1" Phillips Flat  
Head Screw



(9) #10 x 1-1/2" Phillips  
Pan Head Screws



(2) #8 x 1-1/2" Phillips  
Countersunk Screws



(8) #10 x 2-1/2"  
Hinge Screws



(1) Sill Plug

**Part # RPASTHDWPKG**

Astragal Hardware Package

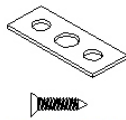

(2) #8 x 3/4" Phillips Flat Head  
Bolt Keeper with Screws

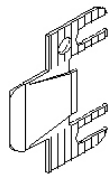

(2) Strike Plates

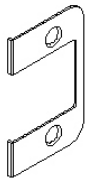

(2) Backing Plates



(6) #10 x 1" Phillips Pan Head  
Astragal Mounting Screws



(4) #7 x 1-1/2" Phillips Flat  
Head Astragal Strike Screws



Sill Plug



(8) #10 x 2-1/2" Phillips  
Flat Head Hinge Screws -  
Jamb Leaf



(8) Strike Plate  
Spacer Washers

# Corner Seal Pads

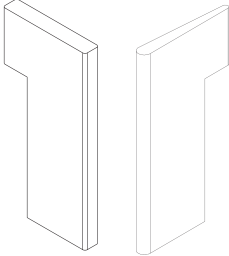

**Part # CCCPKLB**

Bronze Classic-Craft. Left Hand  
Corner Seal Pads

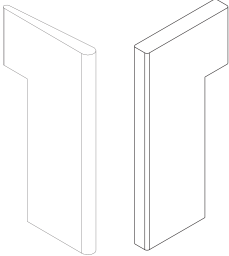

**Part # CCCPKRB**

Bronze Classic-Craft. Right Hand  
Corner Seal Pads

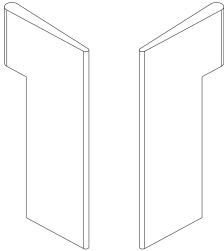

**Part # CPPKB**

Bronze Fiber-Classic. / Smooth-Star.  
Corner Seal Pads

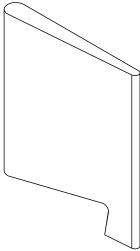

**Part # MSSILPD**

Basic Fixed / Moderate Climate  
Corner Seal Pads

## Door Bottom Sweeps (Gaskets)

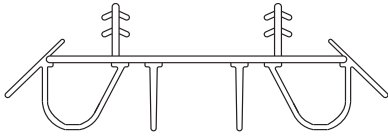

**Part # DBDB280B-50**  
2/8 Kerf-Applied Door Bottom  
Bronze

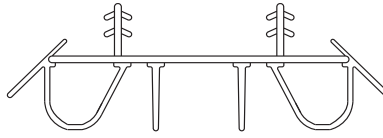

**Part # DBDB300B-50**  
3/0 Kerf-Applied Door Bottom  
Bronze

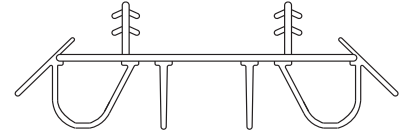

**Part # DBDB300NB**  
3/0 Kerf-Applied Door Bottom for Multi-Point  
Lock System  
Bronze

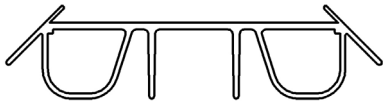

**Part # RPDBDB300B**  
3/0 No Kerf Door Bottom  
Bronze

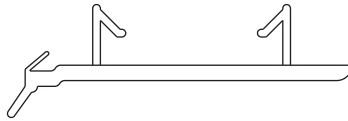

**Part # DB300S99**  
3/0 Outswing Kerf-Applied Door Bottom  
Bronze

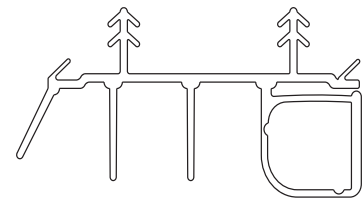

**Part # DB30094**  
3/0 Kerf-Applied Door Bottom  
Bronze

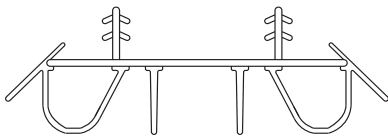

**Part # DBDB140B**  
14\"/>

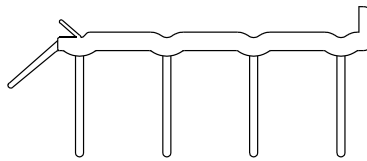

**Part # DB30SWP**  
3/0 Sweep Door Bottom (Pre-1994)  
Bronze

## Sill Gasket

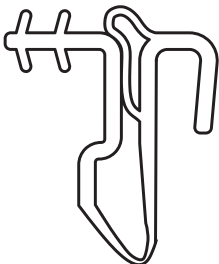

**Part # RPTDSLGSKT60**  
Sill Gasket - Tru-Defense.

## Foot Bolt Kit

Part # PVI-FOOTBOLTKIT-W

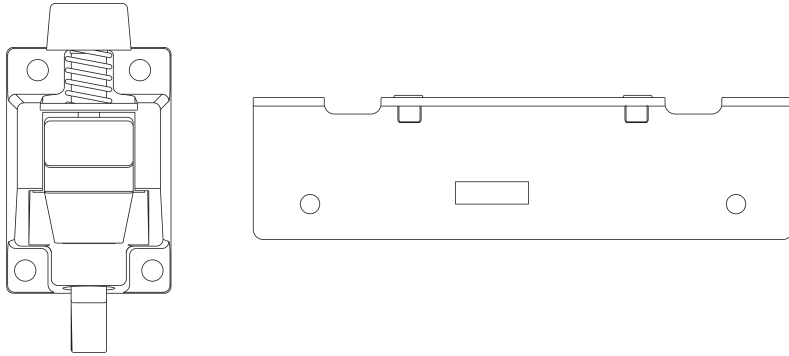

Foot Bolt Kit  
(Vinyl Siding Patio 2008 - Present)  
White

## Divided Lites

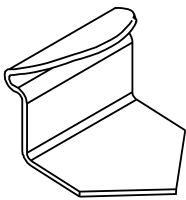

Part # RPCGC  
Classic-Craft Grille Clip

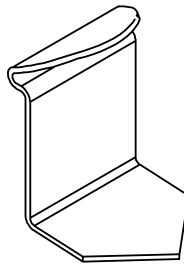

Part # RPWGM2  
Fiber-ClassiC, Smooth-Star, and Steel Wood  
Grille Metal Clip (1994)

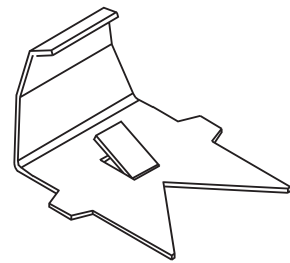

Part # RPFGGC  
Flushed-Glazed Wood Grille Metal Clip

## Hinges & Screws

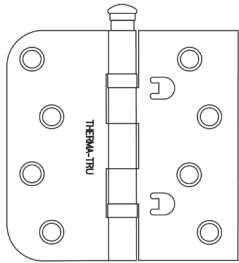

**Part # HGBBL5-YZ**

Self Aligning Ball Bearing  
Zinc Dichromate  
Left Hand Hinge

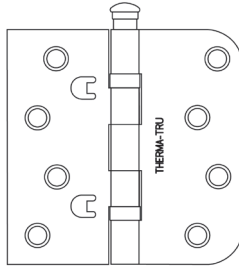

**Part # HGBBR5-YZ**

Self Aligning Ball Bearing  
Zinc Dichromate  
Right Hand Hinge

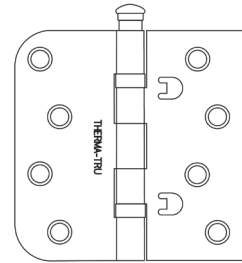

**Part # HGBBL5-1C**

Self Aligning Ball Bearing  
Brushed Nickel Hinge

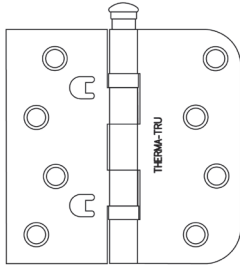

**Part # HGBBR5-1C**

Self Aligning Ball Bearing  
Brushed Nickel  
Right Hand Hinge

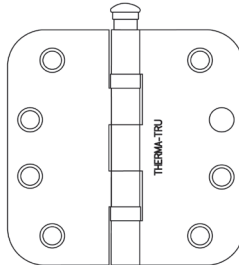

**Part # HGBC5-YZ**

Classic-Craft. Ball Bearing  
5/8" Zinc Dichromate Hinge

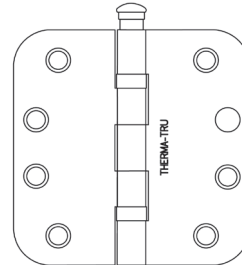

**Part # HGBCC5-1C**

Classic-Craft. Ball Bearing  
5/8" Brushed Nickel Hinge

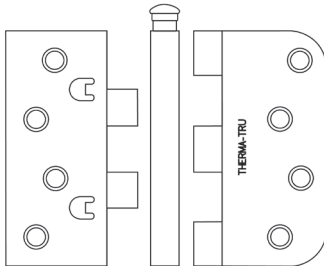

**Part # HG58-1C-S**

Self Aligning 5/8" Brushed Nickel -  
Unassembled (Partial) - Hinge

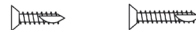
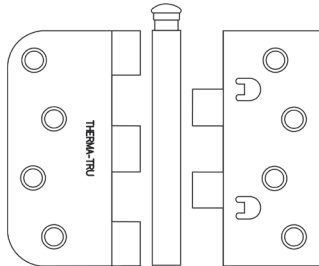

**Part # HG58YZ**

Self Aligning 5/8" Zinc Dichromate -  
Unassembled - Hinge

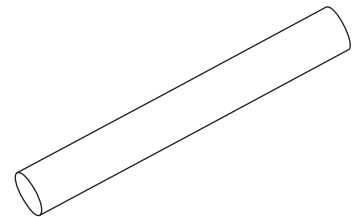

**Part # MS0SLHP**

Zinc Dichromate  
Spring Hinge - Cross Pin

Hinges & Screws *Continued*

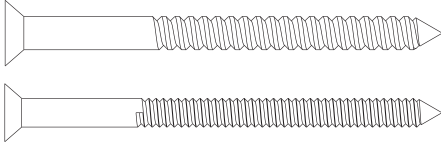

**Part # MSSCRPA**

Zinc Dichromate  
Screw Package "A" Strike Plate  
and Hinge Screws

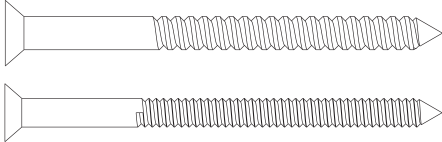

**Part # MSSCRPASS**

Stainless Steel  
Screw Package "A" Strike Plate  
and Hinge Screws

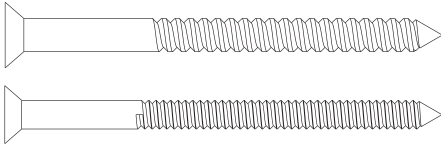

**Part # MSSCRPA-1C**

Brushed Nickel  
Screw Package "A" Strike Plate  
and Hinge Screws

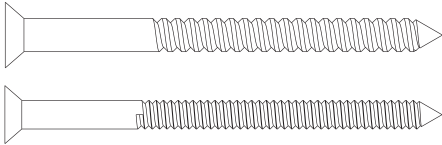

**Part # MSSCRPA-1D**

Black Nickel  
Screw Package "A" Strike Plate  
and Hinge Screws

## Plugs on Frame

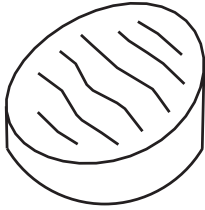

**Part # RPCCMCAP**

SMC Classic-Craft. Frames  
Mahogany Doorlite Screw Cap

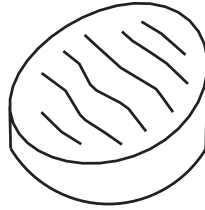

**Part # RP750CAP**

SMC Classic-Craft. Frames  
Oak Doorlite Screw Cap



**Part # RPBTSCAP**

White BTS Frames Doorlite Screw Cap



**Part # RPVBLCAP**

"270" / DL 137 / Internal Blinds Doorlite Screw  
Cap (Pre-2007)

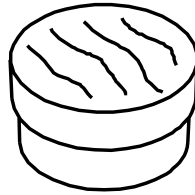

**Part # RPTCMCAP-B**

Buff TCM Fiber-Classic. Frames  
Doorlite Screw Cap

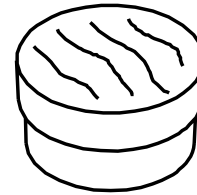

**Part # RP200CAP**

Oval Frames Doorlite Screw Cap



**Part # RPBTSCAPB**

Beige BTS Frames Doorlite Screw Cap

## Rain Deflector & Rain Guard

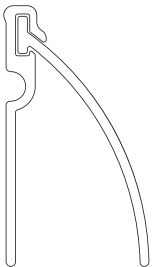

**Part # HPRD30W**

3/0 Painted White Rain Deflector



**Part # RGP30B**

3/0 Bronze Rain Guard



# Weatherstrip

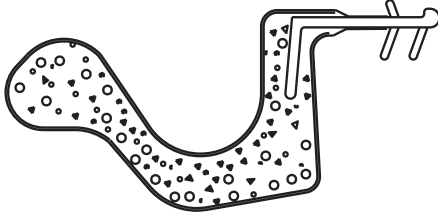

**Part # WS8FB**  
8/0 Bronze  
Long Reach Side Weatherstrip

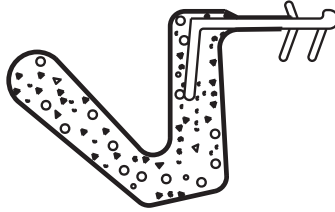

**Part # WS8FB6**  
8/0 Bronze  
Short Reach Side Weatherstrip

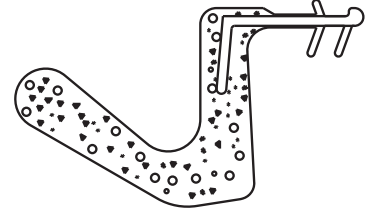

**Part # WS8FB7**  
8/0 Bronze  
Medium Reach Side Weatherstrip

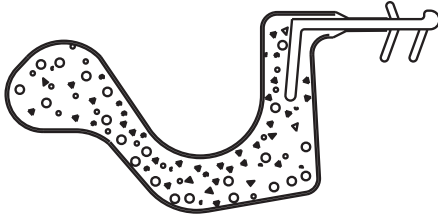

**Part # WS8FT**  
8/0 Stone  
Long Reach Side Weatherstrip

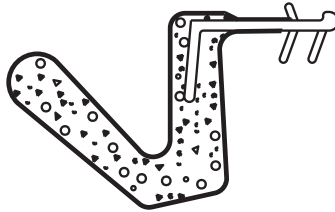

**Part # WS8FT6**  
8/0 Stone  
Short Reach Side Weatherstrip

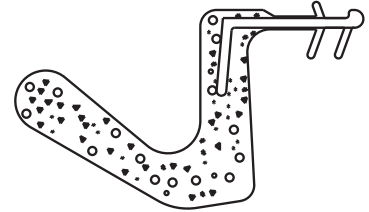

**Part # WS8FT7**  
8/0 Stone  
Medium Reach Side Weatherstrip

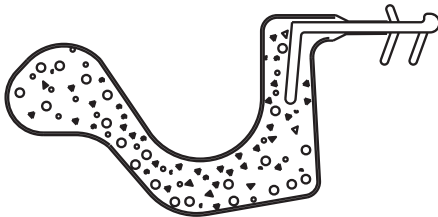

**Part # WS8FW**  
8/0 White  
Long Reach Side Weatherstrip

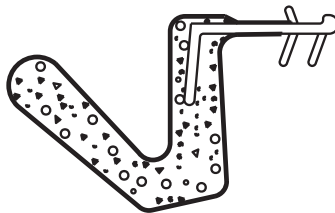

**Part # WS8FW6**  
8/0 White  
Short Reach Side Weatherstrip

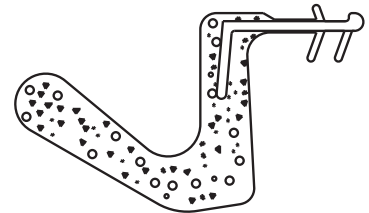

**Part # WS8FW7**  
8/0 White  
Medium Reach Side Weatherstrip

## Internal Blinds

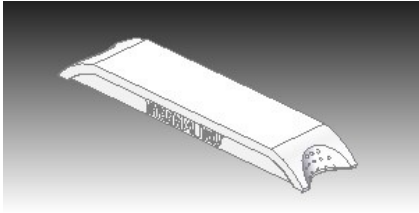

**Part # RPVBRHANDLE-1**

Replacement Handle

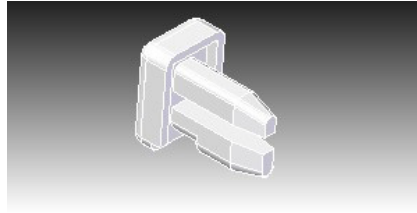

**Part # RPVBRCAP-1**

Replacement End Cap

## Same-Day® Stain Kit



**Part # MATT12CDL**

Cedar Same-Day Stain Finishing Kit

**Part # MATT12MHL**

Mahogany Same-Day Stain Finishing Kit

**Part # MATT12CHL**

Cherry Same-Day Stain Finishing Kit

**Part # MATT12NOL**

Natural Oak Same-Day Stain Finishing Kit

**Part # MATT12EWL**

English Walnut Same-Day Stain Finishing Kit

**Part # MATT12WLL**

Walnut Same-Day Stain Finishing Kit

**Part # MATT12LOL**

Light Oak Same-Day Stain Finishing Kit